

HOLOCAUST HANDBOOKS · VOLUME 8

TREBLINKA

EXTERMINATION CAMP OR TRANSIT CAMP?



НИКОГДА БОЛЬШЕ
NEVER AGAIN
JAMAIS PLUS
NIE WIEDER
! לא עוד !
נִיגְדֵי וְיֵעֶשֶׂי

CARLO MATTOGNO & JÜRGEN GRAF

PUBLISHED BY CASTLE HILL PUBLISHERS

Treblinka

Extermination Camp or Transit Camp?

CAVEAT: The first two editions of the present book appeared in 2004 and 2005. Since that time, the authors have found a wealth of additional documents and testimonies. Most of them are discussed in the two-volume, 1396-page study of 2013 titled *The “Extermination Camps” of “Aktion Reinhardt”*: An Analysis and Refutation of Factitious “Evidence,” Deceptions and Flawed Argumentation of the “Holocaust Controversies” Bloggers, and authored by Carlo Mattogno, Jürgen Graf and Thomas Kues. It deals with all three “Aktion Reinhardt” camps (Belzec, Sobibor and Treblinka). Readers interested in a more-thorough study of the present topic are advised to also consult this study, which can be downloaded as a PDF file free of charge at www.HolocaustHandbooks.com (Volume 28). Most of the new insights presented in that voluminous study were not included in the present slightly expanded edition. However, we have included an update on “Modern Forensics at Treblinka” starting on page 311.

Castle Hill Publishers

Treblinka

Extermination Camp or Transit Camp?

Carlo Mattogno and Jürgen Graf



Castle Hill Publishers

P.O. Box 243, Uckfield, TN22 9AW, UK

3rd edition, May 2020

HOLOCAUST HANDBOOKS, Volume 8:

Carlo Mattogno, Jürgen Graf:

Treblinka: Extermination Camp or Transit Camp?

Slightly expanded 3rd edition

With an epilogue by Germar Rudolf and a supplement by Thomas Kues

Uckfield, East Sussex: CASTLE HILL PUBLISHERS

P.O. Box 243, Uckfield, TN22 9AW, UK

May 2020

ISBN13: 978-1-59148-252-9 (print edition)

ISBN10: 1-59148-252-6 (print edition)

ISSN: 1529-7748

Published by CASTLE HILL PUBLISHERS

Manufactured worldwide

© 2002, 2004, 2005, 2020 by Carlo Mattogno, Jürgen Graf

Distribution:

Castle Hill Publishers

PO Box 243,

Uckfield, TN22 9AW, UK

<https://shop.codoh.com>

Set in Times New Roman.

www.HolocaustHandbooks.com

Cover illustrations: top: Treblinka model by Yaakov Wiernik, located in the Ghetto Fighters' House Museum, Israel (Dr. Avishai Teicher, 7 May 2013, <https://commons.wikimedia.org>, museum surroundings removed); bottom left: Treblinka Memorial, close-up (Adrian Grycuk, 29 June 2013, *ibid.*); bottom right: Treblinka Memorial plaque; background: Treblinka memorial, from a distance (Adrian Grycuk, *ibid.*, sky removed) – a large portion of the campgrounds has been paved over with concrete, and 17,000 rocks, reminiscent of tombstones, have been placed there.

Table of Contents

Page

Introduction	9
Part 1: Treblinka: A Critical Analysis of the Official Version.....	17
Chapter I: The Description of Treblinka in Historiography	19
1. Treblinka in Orthodox ‘Holocaust’ Literature.....	19
<i>a. Vassili Grossmann.....</i>	<i>19</i>
<i>b. Rachel Auerbach.....</i>	<i>23</i>
<i>c. Zdzisław Łukaszewicz</i>	<i>25</i>
<i>d. Nachman Blumental.....</i>	<i>26</i>
<i>e. Marian Muszkat.....</i>	<i>26</i>
<i>f. Jean-François Steiner.....</i>	<i>27</i>
<i>g. Krystyna Marczevska/Władysław Ważniowski.....</i>	<i>29</i>
<i>h. Martin Gray.....</i>	<i>29</i>
<i>i. Gitta Sereny.....</i>	<i>30</i>
<i>j. Stanisław Wojtczak.....</i>	<i>32</i>
<i>k. Adalbert Rückerl.....</i>	<i>32</i>
<i>l. Alexander Donat.....</i>	<i>32</i>
<i>m. The Main Commission’s Encyclopedic Informer.....</i>	<i>33</i>
<i>n. Eugen Kogon, Hermann Langbein, Adalbert Rückerl et al.</i>	<i>33</i>
<i>o. Claude Lanzmann.....</i>	<i>34</i>
<i>p. Yitzhak Arad.....</i>	<i>36</i>
<i>q. Ryszard Czarkowski.....</i>	<i>36</i>
<i>r. J. Gumkowski and A. Rutkowski.....</i>	<i>37</i>
<i>s. Wolfgang Benz.....</i>	<i>37</i>
<i>t. Richard Glazar.....</i>	<i>38</i>
<i>u. Jean-Claude Pressac</i>	<i>40</i>
<i>v. Assessment</i>	<i>40</i>
2. Treblinka in Revisionist Literature	41
<i>a. Treblinka and the Gerstein Report</i>	<i>41</i>
<i>b. Friedrich P. Berg.....</i>	<i>42</i>
<i>c. John C. Ball.....</i>	<i>43</i>
<i>d. Udo Walendy.....</i>	<i>43</i>
<i>e. Arnulf Neumaier.....</i>	<i>45</i>
<i>f. The Thesis of the Transit Camp</i>	<i>45</i>
Chapter II: The Development of the Idea of Treblinka as an	
Extermination Camp.....	47
1. The Secondary Killing Methods	47
2. The Main Killing Method: Steam Chambers.....	50

3. Significance of the Report of November 15, 1942, for Historiography	62
4. From Steam Chambers to Carbon Monoxide Chambers	64
5. Origin of the Carbon Monoxide Version	69
6. Triumph of the Carbon Monoxide Version	74
Chapter III: Investigations, Camp Plans, Statistics	77
1. Soviet Investigations and Forensic Examinations	77
2. Polish Investigations and Forensic Examinations.....	82
3. Assessment of the Investigations	89
4. Plans of Treblinka.....	90
5. Number of Victims of Treblinka: Origin of the Official Figure	96
Chapter IV: The Alleged Extermination Facilities in Treblinka: An Historical and Technical Analysis.....	111
1. Planning and Construction of the Eastern ‘Extermination Camps’	111
2. The Alleged Killing Installations in Treblinka	116
3. Diesel Engine or Gasoline Engine?	121
4. The ‘Struggle’ between Engine Exhaust Gases and Hydrogen Cyanide Gas	125
5. The ‘Mission’ of Kurt Gerstein.....	126
6. Russian Engines or German Engines?	132
7. Gas Chambers or Asphyxiation Chambers?	133
8. The Problem of Air Pressure in Gas Chambers	136
9. The Burning of Bodies: The Mass Graves.....	137
<i>a. Number and Size of the Graves.....</i>	<i>137</i>
<i>b. Site of the Mass Graves</i>	<i>138</i>
<i>c. The Excavated Earth.....</i>	<i>138</i>
<i>d. A Comparison with the Mass Graves of Treblinka I.....</i>	<i>139</i>
<i>e. The Excavators of Treblinka.....</i>	<i>140</i>
10. Early Cremations	141
11. Cremation Facility	143
12. Cremation	145
<i>a. Complexity of the Problem</i>	<i>145</i>
<i>b. Number and Structure of the Cremation Facilities.....</i>	<i>146</i>
<i>c. Arrangement of the Corpses on the Cremation Grates</i>	<i>148</i>
<i>d. Wood Requirement.....</i>	<i>148</i>
<i>e. Ashes</i>	<i>150</i>
<i>f. Wood Supply.....</i>	<i>151</i>
<i>g. Lack of Documentary Evidence for Cremations.....</i>	<i>152</i>
13. Witness Testimonies about Cremations.....	153
14. Number Gassed Daily.....	154
15. Property of Deportees as Material Evidence for their Extermination..	156
<i>a. Hair.....</i>	<i>158</i>

<i>b. Shoes</i>	159
<i>c. Articles of Clothing</i>	159
Chapter V: Treblinka Trials	161
1. Confessions as a Basis for Historiography	161
2. West German Treblinka Trials	162
3. The Demjanjuk Trial in Jerusalem.....	169
Part 2: The Function of Treblinka: An Alternative Interpretation.....	177
Chapter VI: National Socialist Policy of Jewish Emigration.....	179
1. Emigration	179
2. The Madagascar Plan.....	181
3. From Madagascar Plan to Deportation to the East	183
4. Results of the NS Policy of Promoting Jewish Emigration	193
5. The Start of Deportation of Jews to the East	194
6. Direct Transports of Jews to the Eastern Territories.....	196
7. Numerical Data on Direct Transports to the Eastern Territories	199
Chapter VII: The Role of the <i>Einsatzgruppen</i> in the Occupied Eastern Territories	203
1. Initial Situation	203
2. Reasons for Mass Shootings	205
3. The Scale of the Shootings	208
<i>a. The Number of Jews Killed in Latvia</i>	208
<i>b. The Number of Jews Killed in Lithuania</i>	209
<i>c. Lithuanian Jews in Territories Annexed by the Reich</i>	209
<i>d. Simferopol and the Manstein Trial</i>	210
<i>e. Babi Yar</i>	211
<i>f. Jews in Lithuanian Ghettos and Camps Who Were Unfit for Work</i> .	211
<i>g. Jews Unfit for Work in the Ghetto of Brest</i>	214
<i>h. Jews Unfit for Work in the Ghetto of Minsk</i>	214
<i>i. Transfers of Baltic Jewish Children to Stutthof</i>	215
4. Operation 1005	217
5. The Fate of the Western Jews in the East	230
Chapter VIII: Indirect Transports of Jews to the Eastern Territories ..	233
1. The ‘Jewish Reservation’ of Lublin.....	233
2. Transports of Jews into the Lublin District in 1942	234
3. Numerical Analysis of the Transports into the Lublin District.....	242
4. Beginning of the Transports of Jews to Auschwitz	245
5. Auschwitz as a Transit Camp for Western Jews.....	250
6. Final Destination of Jews Deported to the East	253
7. Transfers into the District of Galicia	261

8. National Socialist Policy of Resettlement of Jews in the East According to Demographer Eugene M. Kulischer.....	267
Chapter IX: Transit Camp Treblinka	273
1. Deportations of Jews from the Warsaw Ghetto (1942).....	273
2. Warsaw Ghetto Uprising and the Strop Report	279
3. Deportations from the Ghetto of Białystok and the Transit Camp Małkinia.....	286
4. Treblinka: Gas Chambers or Delousing Chambers?.....	289
5. What Was the Fate of the Deportees?.....	293
Chapter X: Conclusion.....	299
Epilogue	303
Supplement: Modern Forensics at Treblinka	311
Appendices	325
Documents.....	327
Photographs	351
Abbreviations	358
Bibliography.....	359
Index of Names.....	367

Introduction

According to official historiography, several million Jews were killed by poison gas in six National-Socialist camps during the Second World War.

Two of these camps, Auschwitz and Majdanek, are supposed to have originally been established as normal concentration camps, but later served as ‘extermination camps’¹ as well, in which the able-bodied Jews were used in forced labor, while those unable to work were gassed. Furthermore, as the official historical version would have it, there were four ‘pure extermination camps,’ namely Treblinka, Sobibór, Bełżec, and Chełmno (Kulmhof), serving the exclusive purpose of annihilating Jews. Except for a handful of ‘labor Jews,’ who were necessary for keeping the camp in operation, all Jews transported there, regardless of age or state of health, were murdered without any record being made of them.

Treblinka, Sobibór, and Bełżec, often designated in the literature as “camps of Operation Reinhardt,”² were located in the east of the General Gouvernement, thus in German-occupied Poland. In these three camps, mass murder was supposedly committed in stationary gas chambers by means of exhaust gasses from diesel engines. On the other hand, in Chełmno, situated northwest of Lodz, gas vehicles were supposed to have served as murder weapons. According to the official version of history, in all four ‘pure extermination camps’ the corpses of the murdered were initially buried in enormous mass graves, but later, when it became clear that the military defeat of the German Reich was impending, exhumed and burned in the open air.

The claims regarding mass murder and the disposal of bodies are based entirely and exclusively upon eyewitness testimony. Documents from these camps are almost completely missing, which the official version of history explains by saying that either the National Socialists did not compile any or – in the case that documents did exist – they destroyed them in time, enough not to leave behind any proof of their atrocities. For the same reason, it is claimed, Treblinka, Sobibór, Bełżec, and Chełmno were also totally destroyed before the German retreat. In fact, the visitor finds almost no tangible traces at the sites where these camps once were.

¹ The German equivalent of this term – *Vernichtungslager* – does not appear in a single German document of the war period.

² The original of this term, sometimes spelled Reinhardt and sometimes Reinhard, is not clear. This operation, whose purpose consisted, in part, of the confiscation of Jewish property, may owe its name to the State Secretary in the Ministry of Finance, Fritz Reinhardt, or to Reinhardt Heydrich, both spelled with dt.

Under these circumstances, an historian who wishes to check the picture of the four ‘pure extermination camps’ outlined here with scientific methods sees himself confronting a far more difficult task than a researcher who has set himself the same goal with respect to Auschwitz or Majdanek. The latter can study the documents of the camp administration, which are available in great number; he can examine the facilities – some of them preserved in undamaged condition, others in ruins – which according to the prevailing notion served as gas chambers for killing human beings, to see whether their structure was suited for such a function and whether the crematoria were capable of turning into ashes the number of bodies claimed. All of these possibilities are denied to the historian of the ‘pure extermination camps.’

The theme of the present study is Treblinka, which was situated not far from the hamlet of the same name, approximately 80 km northeast of Warsaw. Treblinka is without a doubt the best known of the four ‘pure extermination camps’; in public consciousness, imprinted by media reports, it has become one of the darkest hallmarks of the ‘Holocaust,’ second only to Auschwitz.

The Treblinka Camp consisted of two camps, Treblinka I and Treblinka II. It is undisputed that Treblinka I served purely as a labor camp. The alleged ‘extermination camp’ bore the designation Treblinka II. This was about 4 km distant from the village of the same name, less than 2 km from the Bug River; it was on the train line running from Ostrów Mazowiecki to Siedlce, which intersected with the more important railway line from Warsaw to Białystok at the Małkinia Station. All three of the alleged ‘eastern extermination camps’ were erected in a border zone: Treblinka near the border between the General Gouvernement and the Białystok region, Sobibór not far from the border between the General Gouvernement and the *Reichskommissariat* Ukraine, and Bełżec between the district of Lublin and the district of Galicia.

Treblinka II was situated in an area that was by no means particularly remote, and it concealed few secrets. The train line leading from the village of Treblinka to Siedlce ran at a distance of only 300 meters from the camp, parallel to the nearby road; a branch of this train line led to the camp, and from there to the labor camp Treblinka I. Scarcely two kilometers farther on is the village of Wólka Okrąglik; in the opposite direction, approximately 2 km distant from Treblinka I, were the hamlets of Grady and Poniatowo.³

If one believes the testimony of eyewitnesses, lively contacts existed between the camp inmates and the local populace, with whom a barter trade flourished. The Polish peasants “came with the aim of doing business”;⁴ they brought the prisoners all kinds of food, which they exchanged for gold:⁵

³ See Document 1 in Appendix.

⁴ Witness statement by Samuel Willenberg, in Alexander Donat (ed.), *The Death Camp Treblinka*, Holocaust Library, New York 1979, p. 192.

⁵ Witness statement by Abraham Krzepicki, in A. Donat, *ibid.*, p. 125.

“And so it came to pass that baskets filled with rolls, roasted chickens, cheese, butter, cream, and so forth began to arrive each day at Treblinka.”

A little more than 2 km away from Treblinka II, the Germans had established the Treblinka I Camp, where prisoners were occupied chiefly in the production of gravel from an enormous pit.

The few material traces of Treblinka II,⁶ which still existed at the arrival of the Soviets in August 1944, were completely removed during the course of the years and no longer exist today. From 1959 until 1964, Treblinka attained its present form: a large sector of the camp ground was embedded in concrete and 17,000 cement blocks reminiscent of grave monuments⁷ were erected there. In the center, a gigantic monument of stone⁸ was built. At the entrance to the camp, stones proclaim in several languages that here “more than 800,000 Jews” were killed between July 1942 and August 1943.⁹ Concrete railroad ties, flanked by a platform likewise made of concrete, symbolize the train tracks and the train platform of the camp.¹⁰ Otherwise there is nothing for the eye to see but a meadow rimmed by fir trees.¹¹

One reaches the area where Treblinka I once stood by a forest path of some two kilometers length, and along the way one can see the old gravel pit.¹² Shortly before this, one comes upon a small cemetery where Polish prisoners rest who died in the labor camp.¹³ In an area of the former camp ground, surrounded by a forest of fir trees,¹⁴ concrete foundations can be found, approximately 12 m × 60 m in dimension, upon which former camp barracks stood.¹⁵

In Section 3 of Chapter III, the reader will find a detailed description of the area in which Treblinka I and Treblinka II were located.

From time to time during the immediate postwar period, there was talk of up to three million people having been murdered in Treblinka II.¹⁶ The two most important standard works of contemporary ‘Holocaust’ historiography mention the number of victims as 750,000 (Raul Hilberg),¹⁷ or as 870,000 (*Encyclopedia of the Holocaust*).¹⁸

⁶ See Chapter III.

⁷ See Photo 1 in the Appendix.

⁸ See Photo 2 in the Appendix.

⁹ See Photo 3 in the Appendix.

¹⁰ See Photo 4 in the Appendix.

¹¹ See Photo 5 in the Appendix.

¹² See Photo 6 in the Appendix.

¹³ See Photo 7 in the Appendix.

¹⁴ See Photo 8 in the Appendix.

¹⁵ See Photo 9 in the Appendix.

¹⁶ This number was given by, for example, Wassili Grossmann in *Die Hölle von Treblinka*, Verlag für fremdspachige Literatur, Moscow 1946 (see Chapter 1).

¹⁷ Raul Hilberg, *The Destruction of the European Jews*, 3 vols., Holmes & Meier, New York 1985, p. 893, 1219.

¹⁸ Israel Gutman (ed.), *Encyclopedia of the Holocaust*, 4 vols., Macmillan, New York 1990,

The last named standard work, the *Encyclopedia of the Holocaust*, contains a summary of the official picture of the Treblinka Camp, which we reproduce in the following excerpt:¹⁹

“[Treblinka] was situated in a sparsely populated area near Malkinia, a railway station on the main Warsaw-Bialystok line; the camp’s precise location was 2.5 miles (4 km) northwest of the village and railway stop of Treblinka. The site selected was heavily wooded and well hidden from view. A penal camp, known as Treblinka I, had been set up nearby in 1941; Poles and Jews were imprisoned there, working in quarries^[20] from which they extracted materials used in the construction of fortifications on the German-Soviet border.^[21] The extermination camp was established as part of AKTION REINHARD [Operation Reinhardt]; work on it began in late May and early June of 1942 and was completed on July 22 of that year. The project was carried out by German firms, using inmates of Treblinka I and Jews brought in from neighboring towns. In addition to the camp structures and gas chambers, a branch railway track, leading from the camp to the nearby railway station, was constructed. Huge pits were dug within the camp grounds to be used as mass graves.

The camp was laid out in a rectangle 1,312 feet wide by 1,968 feet long (400 x 600 m), [...].

The extermination area, called the ‘upper camp’ by the Germans, was in the southeastern part. Covering an area of 656 by 820 feet (200 x 250 m), it was completely fenced in and separated from the rest of the camp. In this area was a brick building containing three gas chambers, each measuring 13 by 13 feet (4 x 4 m). An adjoining shed housed a diesel engine that produced the carbon monoxide for the chambers. The gas was introduced by way of pipes attached to the ceilings of the gas chambers that ended in what looked like shower heads, to create the impression that the chambers were merely bathhouses. In the building a hallway led to each of the three gas chambers; inside each, facing the entrance, was a second door through which the dead bodies were removed. At a distance of 492 to 656 feet (150-200 m) from the gas chambers, to the east of the building, lay the huge trenches in which the bodies were interred. A narrow path, fenced in on each side and camouflaged with tree branches, led from the reception area to the extermination area. It was along this path, nicknamed the ‘pipe,’ or ‘tube’ (Schlauch), that the Jews, now naked, were driven to the gas chambers.

Vol. 4, p. 1486.

¹⁹ *Ibid.*, pp. 1481-87.

²⁰ More correct would be: ‘In a gravel pit.’

²¹ The last half sentence was omitted in the German version, Vol. 1, p. 1427, as there was no German-Soviet border during that time. The German version also correctly states that the camp was built under the aegis of the “SS-Zentralbauleitung Warschau.”

The camp's first commander was SS-Obersturmführer Irmfried Eberl. In August 1942 he was replaced by SS-Obersturmführer Franz STANGL, the former commander of Sobibór. The German staff, numbering between 20 and 30 SS men, all of whom had taken part in the EUTHANASIA PROGRAM, held the command and administrative positions in the camp. A Ukrainian company consisting of 90 to 120 men served as camp guards and security personnel. They had the tasks of ensuring that no Jews would escape and of quashing any attempt at resistance. Some of the Ukrainians were given other duties, including the operation of the gas chambers. Most of them were Soviet prisoners of war who had volunteered to serve the Germans and had been enlisted and trained for their duties at the TRAWNIKI camp. [22 ...]

Groups of Jewish prisoners were employed on construction work as well, which proceeded even while the extermination process was in operation. They were also kept busy cutting tree branches in the adjoining woods and using them for camouflage, as well as on other jobs. These prisoners were taken from the incoming transports, put to work for a few days or weeks at the most, and then selected out and killed, their places taken by new arrivals. [...]

The Treblinka extermination process was based on experience the Germans had gained in the BELŻEC and Sobibór camps. An incoming train, generally consisting of fifty to sixty cars (containing a total of six thousand to seven thousand persons), first came to a stop in the Treblinka village railway station. Twenty of the cars were brought into the camp, while the rest waited behind in the station. As each part of a transport was due to enter the camp, reinforced Ukrainian guard detachments took up position on the camp railway platform and in the reception area. When the cars came to a stop, the doors were opened and SS men ordered the Jews to get out.

A camp officer then announced to the arrivals that they had come to a transit camp from which they were going to be dispersed to various labor camps; for hygienic reasons, they would now take showers and have their clothes disinfected. Any money and valuables in their possession were to be handed over for safekeeping and would be returned to them after they had been to the showers. Following this announcement, the Jews were ordered into the 'deportation square.'

At the entrance to the square, the men were ordered into a barrack on the right and the women and children to the left. This had to be done on the run, with the guards shouting at them, driving them on, and beating them. The women and children were made to enter a barrack on the left side of the square, where they had to undress. Beginning in the fall of 1942, the

²² The Trawniki Camp, situated southeast of Lublin, served among other purposes as a training site for the concentration camp personnel.

women's hair was shorn at this point, behind a partition that was put up for this purpose. From the barrack, they entered, naked, the 'pipe' that led to the gas chambers. Women and children were gassed first, while the men were kept in the deportation square, standing naked and waiting until their turn came to enter the 'pipe.' Once the victims were locked inside the gas chambers, which had the appearance of shower rooms, the diesel engine was started and the carbon monoxide poured in. In less than thirty minutes, all had died of asphyxiation. Their bodies were removed and taken to the trenches for burial. [...]

A group of two hundred to three hundred, kept apart from the other Jewish prisoners, was employed in the extermination area, on such tasks as removing the corpses from the gas chambers, cleaning the chambers, extracting the victims' gold teeth, and burying their bodies. When the practice of cremating the bodies was introduced in the spring of 1943, with the aim of removing all traces of the mass murder that had been committed in Treblinka, this group of prisoners was charged with the task.

The Germans soon realized – as they previously had at Bełżec and Sobibór – that the bottleneck in the extermination process at Treblinka was the limited capacity of the gas chambers, which covered an area of no more than 57 square yards (48 sq m). It was therefore decided to increase the number of gas chambers, and ten more were built between the end of August and the beginning of October 1942, with a total area of 383 square yards (320 sq m). They were inside a brick building that had a hallway down the center and five doors on each side, each door leading to a gas chamber. A second door in each chamber could be opened only from the outside and was used to remove the corpses. The capacity of the new gas chambers was more than sufficient for the entire human load of twenty railway cars at one time. [...]

The mass extermination program at Treblinka went into effect on July 23, 1942, and the first transports to reach the camp were made up of Jews from the Warsaw ghetto. Between that date and September 21, 254,000 Jews from Warsaw and 112,000 from other places in the Warsaw district were murdered at Treblinka, making a total of 366,000 from the district. From the Radom district 337,000 Jews were murdered, and from the Lublin district 35,000, most of them before the winter of 1942-1943. [...]

From the Białystok district, over 107,000 Jews were taken to Treblinka to be killed, most of them between November 1942 and January 1943.

Jews from outside Poland were also killed at Treblinka. From Slovakia, 7,000 Jews who had first been deported to ghettos in the Generalgouvernement were murdered in the summer and fall of 1942; from THeresienstadt, five transports brought 8,000 Jews in the period from October 5 to October 25, 1942. From GREECE, over 4,000 Jews who had first been deported from their homes in THRACE to Bulgaria came in the latter half of

March 1943; and from MACEDONIA, the part of Yugoslavia that Bulgaria had annexed, 7,000 Jews were murdered in Treblinka at the end of March and the beginning of April 1943. From Salonika, at least one transport of 2,800 Jews came at the end of March 1943.

A total of 29,000 Jews from countries other than Poland were murdered at Treblinka. Two thousand GYPSIES as well were among the victims there. The mass extermination program continued until April 1943, after which only a few isolated transports arrived; the camp had fulfilled its function.

In late February and early March of 1943, Heinrich HIMMLER visited Treblinka; following this visit, in accordance with his orders, an operation was launched to burn the bodies of the victims. The mass graves were opened and the corpses were taken out, to be consumed by the flames of huge pyres (the 'roasts'). The bones were crushed and, together with the ashes, were reburied in the same graves. This burning of corpses in an effort to obliterate traces of the killings was continued until the end of July 1943. On its completion, the camp was shut down, in the fall of 1943. A total of 870,000 people had been murdered there. [...]

Several efforts at resistance were made in Treblinka, both by individuals and by entire transports, [...] At the beginning of 1943, a resistance group was formed among the inmates. [...]

When the burning of the bodies was nearing completion and it was clear that both the camp and the prisoners were about to be liquidated, the leaders of the underground resolved that the uprising must not be postponed any longer. A date and time were fixed: the afternoon of August 2, 1943. [...] those resistance members who had arms in their hands opened fire at the SS men and set some of the camp buildings on fire. Masses of prisoners now tried to storm the fence and escape from the camp; they were fired at from all the watchtowers and most of them were hit, falling in or near the fence area. Those who succeeded in getting out of the camp were apprehended and shot by additional German security forces who had been alerted to the scene and, pursuing the escaped prisoners, combed the surrounding area. Of the approximately seven hundred and fifty prisoners who had tried to make their escape, seventy survived to see liberation.

Most of the camp structures, except for the gas chambers, were made of wood and went up in flames. Of the prisoners who were left, some were killed on the spot, while the rest were made to demolish the remaining structures and fences and obliterate the traces of the activities that had taken place at the camp. When this work was over, these prisoners too were shot. The grounds were plowed under and trees were planted; the camp was turned into a farm, and a Ukrainian peasant family was settled there."

Such is the account of the Encyclopedia of the Holocaust.

We have set ourselves the task of subjecting the portrait of the ‘extermination camp’ of Treblinka as summarized above to a critical examination, and should it not stand up to this examination, of offering an alternative thesis regarding the real function of the camp.

Jürgen Graf is responsible for the Introduction, Chapter 1, Chapter 5, and the Conclusions. Carlo Mattogno bears responsibility for all of the remaining chapters.

We express our sincere gratitude to Prof. Robert Faurisson, Mark Weber, and Dr. Miroslav Dragan for sending important material and/or suggestions regarding publications germane to our subject.

It was originally planned to include the results of the ground radar investigations in this book as carried out at Treblinka by Engineer Richard Krege¹⁶. However, in view of the significance of the subject as well as the expansion of the ground radar investigations to the camps Bełżec and Auschwitz, it was decided to treat this topic in a work of its own, which will be published by the same publishers as this work.

Our book is dedicated to our late friend, certified engineer Arnulf Neumaier, a tireless fighter for the historical truth, whose article “The Treblinka Holocaust,” published in the anthology *Dissecting the Holocaust*, represents a milestone in the scientific research of this camp.

Part 1:
Treblinka: A Critical Analysis
of the Official Version

Chapter I: The Description of Treblinka in Historiography

1. Treblinka in Orthodox ‘Holocaust’ Literature

An historian normally makes a sharp distinction between books of non-fiction and novels. In the case of the orthodox literature on Treblinka, *i.e.*, that supporting the thesis of the mass extermination in gas chambers, this distinction is hardly possible: even advocates of the official account of Treblinka who lay claim to scholarship must, in view of the total absence of material and documentary evidence, necessarily rely upon witness testimony, the value of which will be dramatically demonstrated to the reader by the following examples. For this reason, we have forsworn any attempt at making such a distinction in our chronological overview of the most important works, which have appeared since 1945 and are dedicated entirely or in part to the Treblinka Camp.

a. Vassili Grossmann

We begin with the publication *Treblinka Ad* (The Hell of Treblinka) by the Soviet-Jewish author Vassili Grossmann (also spelled Vassili Grossman), which appeared in 1945. The work was not available to us in book form, but rather in the form of a marked-up manuscript that we found in a Russian archive.²³ It is not dated, but it emerges from the context that it must have originated at the end of 1944 or beginning of 1945. A French²⁴ as well as a Polish²⁵ version appeared in 1945 under the titles *L'enfer de Treblinka* and *Piekło Treblinka*, respectively. Likewise, a German version followed in 1945 in a book, which also contained a report by Konstantin Simonov on Majdanek;²⁶ a sec-

²³ GARF 7021-115-8, pp. 168-203.

²⁴ V. Grossman, *L'enfer de Treblinka*, B. Arthaud, Grenoble and Paris 1945. The text is also found in: *Le Livre Noir, Textes et témoignages*, Ilja Ehrenburg, Vassili Grossman (eds.), Actes Sudes, Arles 1995, pp. 868-903. The latter book represents the translation of a Russian original, the publication of which was prohibited by the Soviet government in 1947 and which was first published in 1993 in Vilnius (Lithuania).

²⁵ Published by Wydawnictwo Literatura Polska, Kattowitz 1945.

²⁶ *Die Vernichtungslager Maidanek und Treblinka*, Stern-Verlag, Vienna 1945.

and German edition, reproduced in part by Udo Walendy in No. 44 of his *Historische Tatsachen*,²⁷ was published in 1946.¹⁶

A comparison of the Russian manuscript with the foreign-language translations shows that the latter are somewhat longer. Thus the Russian book version, upon which these translations are based, is an expansion of the manuscript in question.

Grossmann's work represents a classic example of atrocity propaganda. We now cite some excerpts from the German 1945 edition:²⁶

"In Treblinka there were two camps: the labor camp No. 1, in which prisoners of various nationalities, above all Poles, worked, and camp No. 2, the Jewish camp.

Camp No. 1 – the work or concentration camp – was located directly next to the sand pit, at the edge of the forest. It was a camp like those, which were established by the hundreds and thousands in the occupied eastern territories by the Gestapo. It began in 1941. As if reduced to one common denominator, the traits of the German character, grotesquely disfigured by the frightful fun house mirror of the Hitler regime, are combined in it. [p. 27f...]

The No. 1 Camp existed from autumn of 1941 [until] July 23, 1944. It was completely liquidated while the prisoners were already in earshot of the dull boom of the Soviet artillery. Early in the morning of July 23, the guard unit and the SS people proceeded to exterminate the camp after they had fortified themselves with schnapps. By the evening all of the prisoners had been murdered – murdered and buried. The Warsaw cabinetmaker Max Lewit was able to save himself, because lying wounded underneath the corpses of his comrades, he had waited for the darkness and crept into the forest. He told how he heard the singing of thirty boys in the pit who struck up the tune 'Song of the Fatherland' before being shot to death; he heard one of the youngsters yell: 'Stalin will avenge us!' He heard the camp favorite Leib, who had led the boys, get up again after falling down into the pit after the volley hit him, and ask: 'Pan^[28] Guard, they missed; please, once more Pan Guard, once more!' [p. 29...]

We know the names of the camp SS men, their characters, idiosyncrasies, we know the camp commander van Eipen, a half-Dutch German, who is an insane murderer, an insatiable libertine, a lover of good horses and fast riding jaunts. [...]

We know the one-eyed German Swiderski from Odessa, the 'Master Hammerer,' who was regarded as the unsurpassable specialist of 'dry murder,' because within a few minutes he killed with a hammer fifteen children between the ages of eight and thirteen years, who had been designated as un-

²⁷ "Der Fall Treblinka," Verlag für Volkstum und Zeitgeschichtsforschung, Vlotho 1990.

²⁸ Polish form of address corresponding to English "Sir" or "Mister" – Translator's note.

fit for labor. We know the skinny, gypsy-like SS man Preifi, nicknamed 'the Old Man,' a taciturn grouch. He sought to dispel his melancholy by sitting behind the place where the camp slops were dumped; he stalked the prisoners who sneaked back there to secretly eat potato peels and forced them to open their mouths and then shot into those widely opened mouths. We know the names of the professional murderers Schwarz and Ledecke. They took delight in shooting at the prisoners returning home in the twilight and murdered twenty of them a day. Thirty, forty men. [p. 29f.]

Such was life in this camp, similar to a miniature Majdanek, and it might seem that there could be nothing worse in the world. But the inmates of Camp No. 1 knew quite well that there was something worse, something a hundred times more horrible than their own camp. Three kilometers from the labor camp, the Germans began in May 1942 the construction of the Jewish camp – the human slaughterhouse. [p. 31...]

For thirteen months the trains came to Treblinka, each train consisting of sixty cars, and on each car a number was written with chalk: one hundred fifty – one hundred eighty – two hundred. These figures indicated the number of people who were in the car. Train workers and peasants secretly counted the trains. One peasant from the village of Wulka (the community situated closest to the camp), the sixty-two-year-old Kazimierz Skarzinski, told me that there were days when six trains ran past Wulka alone, over the Siedlce railway, and that there wasn't one day during the course of these thirteen months that at least one of these trains didn't come through. But the Siedlce line is just one of the four train lines which supplied Treblinka. Lucian Cukowa, a railway repair worker, who the Germans had mobilized for work on the branch line that goes from Treblinka to Camp No. 2, relates that during his work from June 15, 1942, until August 1943, one to three trains came every day from Treblinka Station to the camp over this secondary line. Every train consisted of sixty cars and in each car were no fewer than one hundred fifty persons. We have collected dozens of such statements. Even if we reduced all the numbers, as given by the witnesses, of all those who were on the trains to Treblinka by about a factor of two, the number of people brought to Treblinka within thirteen months nevertheless amounts to approximately three million. [p. 31f.]

In the report on this last tragic train, all witnesses mention the atrocities of an anthropoid creature, the SS man Zepf. He specialized in the murder of children. This creature, who had at his disposal enormous strength, suddenly grabbed a child from out of the crowd and, after he had swung him through the air like a club, smashed in his skull on the ground or tore him right in two. When I heard of this monster, obviously born of a woman, it seemed to me unthinkable and improbable that the acts that were told of him could be true. But after I had personally heard these reports repeatedly from direct eyewitnesses, I saw that they spoke of them as of details,

which were neither unusual nor inconsistent with the entire structure of the Hell of Treblinka, and I believed in the possibility of such a creature. [p. 43...]

The dimensions of the first three chambers were only five by five meters, which means that each had twenty-five square meters. Each chamber was one hundred ninety centimeters high. It had two doors; one admitted the living, the other served for bringing out the gassed corpses. This second door was very wide, approximately two and a half meters. The chambers were mounted upon a common foundation. These three chambers did not correspond to the productive capacity demanded by Berlin in assembly-line murder. [...]

The seven hundred prisoners worked five weeks long on the structure of the new large-scale murder business. When the work had reached its peak, an expert came with his staff from Germany and took care of setting things up. The new chambers, ten in all, were symmetrically arranged on either side of a concrete corridor. [...]

The new chambers were each seven by eight meters, or fifty-six square meters in area. The total surface area of these ten chambers amounted to five hundred sixty square meters, and if one added to this the area of the three old chambers, which were put into service at the arrival of small parties, then Treblinka had at its disposal a total of usable lethal surface area of six hundred thirty-five square meters. Four hundred sixty to five hundred people were squeezed into one chamber at a time. When fully loaded, therefore, the ten chambers during one operation annihilated an average of four thousand five hundred people. At their most typical loading, the chambers of the Hell of Treblinka were filled at least two or three times every day (there were days when this happened five times). If we intentionally reduce the figures, we are able to calculate that, with a usage of only twice per day of just the new chambers, approximately ten thousand people were murdered in Treblinka on a single day, and about three hundred thousand in a month. Treblinka operated for thirteen months, day after day, but if we allow even ninety days to be deducted for repairs, idleness, untypical transports, there are ten full months of operation. If in one month an average of three hundred thousand people arrive, then within ten months Treblinka exterminated three million people. [p. 47f...]

The duty of the writer is to report a terrible truth, and the citizen's duty as a reader is to learn it. Anyone who turns away, closes his eyes and walks by, desecrates the memory of the murdered. Whoever does not know the whole truth can never grasp against what foe, what monstrosity, the great Red Army took up the deadly struggle. [p. 55...]

We entered the camp of Treblinka at the beginning of September [1944], which was thirteen months after the day of the revolt. For thirteen months the Germans had tried to erase the traces of their work. [...]. And the

earth, giving way under one's feet, is fatty and swollen, as if it had been soaked in a surfeit of linseed oil; the unsolid earth of Treblinka wells up like an eddying sea. This wasteland, surrounded by barbed wire fencing, has consumed more human lives than entire oceans and seas of the globe since the existence of the human race." (p. 61f.)

In his edifying report Grossmann writes that there were three methods of mass killing: gassing, scalding with hot steam, and suffocation by evacuation of the death chamber by means of vacuum pumps. We shall return to this theme in the following chapter. In any case, the second as well as the third murder method very soon took their leave from history; only the gas chambers have remained. The number of Treblinka victims, postulated several times by Grossmann as three million, was also dropped at that time as being obviously all too incredible, and in the publications that followed writers contented themselves with significantly lower numbers of victims.

b. Rachel Auerbach

In 1946, the Polish Jewess Rachel Auerbach, who had not been interned in Treblinka herself but had supposedly received her information from former inmates, wrote a work in the Yiddish language about the camp, which was published in 1979 in English by Alexander Donat under the title *In the Fields of Treblinka*.²⁹ Auerbach attacked Grossmann on the basis of the number of three million victims claimed by him. She gives the number of victims with precision as 1,074,000 and writes:

"Such places as Treblinka, with their huge mass graves, do not need that sort of odd local patriotism which is expressed by exaggerating the number of victims in order to depict the monstrosity of the mass murders committed there. Believe me, over a million people killed in the course of one year in one little place is a million times more than a million human brains could grasp. And even half a million would be much more than enough." (p. 55)

This praiseworthy refusal to indulge in any kind of exaggeration aside, the authoress reports, among other things, the following concerning Treblinka:

"The floor of the gas chambers was sloping and slippery. The first ones in would slip and fall, never to rise again. Those who followed would topple over them. The chamber was packed to the brim. The people were jammed together so closely that they pushed each other into a standing position. Some witnesses report that the people inside the chambers had to raise their arms and pull in their stomachs so that more could be fitted in. And then, when they stood pressed together, little children were slipped in above their heads like so many bundles.

Gas was costly and therefore had to be used economically.

At last, the doors were slammed shut.

²⁹ Rachel Auerbach, "In the Fields of Treblinka," in: A. Donat, *op. cit.* (note 4), pp. 19-73.

The shift was ready to die.

The motor, installed in a workshop near the bathhouse, could be started now. First, a suction pump was brought into play to draw the pure air from the chamber. After that, the pipes to the reservoir of exhaust gas from the motor could be opened.

'A few minutes later,' Jews who had worked in that part of the camp recalled, 'we would hear terrible screams from that building.' The screams of human pain, terror and despair. At the last moment, it seems, when the pumps started to suck out breathable air, all self-control broke, and there was an outbreak of collective hysteria inside the gas chamber.

Later... in due time... all was quiet again...

Perhaps 25 to 45 minutes later, the chutes on the other side could be opened and the corpses tumbled out. The bodies were naked; some of them were white, others were blue and bloated. [p. 35f...]

Therefore, in Treblinka as in other places, children were often thrown live into the fire, or into the regular mass grave. The most important consideration was to conserve bullets or gas whenever possible. It was also believed that children did not die as easily and quickly from a bullet or from gas as adults did. Doctors had given some thought to this matter, and they had concluded that children have better circulation because their blood vessels were not yet hardened." (p. 38f.)

Auerbach surprises her readers with trail-blazing scientific findings such as the discovery that blood "was found to be a first-class combustion material" (p. 38), and imparts the information that the gassing of many thousands of Jews per day was conducted by "30 to 40 SS-men, and 200 to 300 Ukrainian guards,"³⁰ by which she provides a record not especially flattering to her co-religionists. Concerning the artistic events and other diversions in Treblinka, she has the following to say:

"In order to enliven the monotony of their murderous work, the Germans installed at Treblinka a Jewish orchestra. This was in keeping with the established procedure in other camps. This orchestra had a twofold purpose: first, to drown out, as much as that was possible, the screams and moans of the people being driven to their death in the gas chambers; the second, to provide musical entertainment for the camp staff, who represented two music-loving nations – Germany and the Ukraine! A band was needed also for the frequent entertainments, which were arranged here. In time, a choir was organized, and there were even amateur theater performances, but unfortunately the outbreak of the uprising frustrated the great plans for the advancement of culture and art, which had been concocted for Treblinka. [p. 44...]

³⁰ *Ibid.*, p. 40.

It is said that when Himmler visited Treblinka late in February, 1943 a special 'attraction' should be prepared for him: a party of young women, who had been specially selected for this purpose so that the supreme SS and police chief of the Reich could take aesthetic pleasure in looking at their nude bodies as they demonstrated the workings of the camp, being driven into the 'bathhouse' and then dumped out as corpses...

As the Italian saying goes: 'Se non è vero, è ben trovato.'" (p. 48)

The last sentence means: "Even if it's not true, it's well invented." This applies in full compass to Rachel Auerbach's 'factual report' about Treblinka.

c. Zdzisław Łukaszkiwicz

Likewise in the year 1946, there appeared in the bulletin of the Main Commission for the Investigation of German Crimes in Poland³¹ a thirty-page article by Judge Zdzisław Łukaszkiwicz under the title "*Obóz zagłady Treblinka*"³² (The Extermination Camp Treblinka). In the introduction to this work, in which the "preliminary investigations" are described, the author states:

"The basis of the evidentiary material, upon which the preliminary investigations rest as represented in the following, is above all the witness statements of thirteen Jews, former prisoners of the camp Treblinka, who managed to escape death by the fact that during the armed revolt of August 2, 1943, they fled the camp. The following are the witnesses: Jankiel Wiernik, Henryk Poswolski, Aron Czechowicz, Abe Kon, Oskar Strawczyński, Samuel Reisman^[33], Aleksander Kudlik, Hejnoch Brenner, Stanisław Kon, Eugeniusz Turowski, Henryk Reichman^[34], Szyja Warszawski and Leon Finkelsztejn."

As supplementary evidence, Łukaszkiwicz mentions the statements of eleven Polish railway workers as well as railroad records, from which the number of prisoners brought to Treblinka supposedly derive, and coins and documents excavated from the grounds of the camp as well as the results of forensic investigations and land surveys.³⁵ But the declarations of the thirteen Jewish witnesses are the sole basis of proof for the claimed mass extermination.

³¹ Out of consideration for the allied Communist East German state later renamed 'Main Commission for the Investigation of Hitler Crimes in Poland' and, after the collapse of the Communist regime, 'Main Commission for the Prosecution of Crimes against the Polish People.'

³² Zdzisław Łukaszkiwicz, "Obóz zagłady Treblinka," in *Biuletyn Głównej Komisji Badania Zbrodni Niemieckich w Polsce*, No. 1, Posen 1946, pp. 133-144.

³³ More often spelled as Rajman.

³⁴ This witness later called himself Yehiel Reichman(n). He appeared as a prosecution witness against John Demjanjuk at the Jerusalem trial. Cf. Chapter V.

³⁵ Z. Łukaszkiwicz, *op. cit.* (note 32), p. 133.

According to Łukaszkiwicz, there were *two*³⁶ gas chambers in Treblinka in the beginning, to which ten more were added later. The murders were committed with engine exhaust gas. The bodies were burned under the open sky; 2,500 were placed upon open grates at a time and turned into ashes. In the camp hospital, the Germans and their Ukrainian assistants killed large numbers of prisoners by a shot in the back of the neck; old people, the infirm, and children without relatives were led off directly after their arrival at the hospital and shot. At least 731,600 people were murdered in Treblinka, but the total number of victims was in reality higher.³⁷

In the same year, therefore still in 1946, Z. Łukaszkiwicz compiled a significantly more detailed report about the camp under the title “*Obóz straceń w Treblince*” (The Execution Camp in Treblinka), which to some extent marked the transition from pure atrocity propaganda à la Grossmann and Auerbach to an account, which purported to be scientific.³⁸ Accordingly, the style is also much more sober than is the case with Grossmann and Auerbach, and descriptions of patent impossibilities are rarer. Nevertheless, this work also bears the quite unmistakable stamp of propaganda and possesses but slight scientific value. Łukaszkiwicz tersely gives the number of victims of the camp as 800,000; nearly all of the murdered were Jews, but a certain number of Poles and Gypsies were also killed.

The details given by Łukaszkiwicz correspond in all essential points to the Treblinka version endorsed by the Western orthodox ‘Holocaust’ historians.

d. Nachman Blumental

An eighteen-page report about Treblinka also appeared in Poland in 1946, part of a collection of documents titled *Dokumenty i Materiały* and edited by N. Blumental, a member of the Jewish Central Historical Commission.³⁹ The report consists of an introduction as well as reports of two former Jewish prisoners of the camp, Szymon Goldberg and Samuel Rajzman. We will later cite excerpts from these reports.

e. Marian Muszkat

In 1948, one Marian Muszkat prepared a ‘documentation’ in Poland for the UN Commission for the Investigation of War Crimes, in which Treblinka was mentioned and in which several former inmates of the camp were quoted.⁴⁰ As

³⁶ Later *three* gas chambers were spoken of at first.

³⁷ Z. Łukaszkiwicz, *op. cit.* (note 32), p. 142.

³⁸ Z. Łukaszkiwicz, *Obóz straceń w Treblince*, Państwowy Instytut Wydawniczy, Warsaw 1946.

³⁹ “Treblinka,” in: Wydawnictwo Centralnej Żydowskiej Komisji Historycznej (ed.), *Dokumenty i Materiały*. Tom I: *Obozy*, revised by N. Blumental, Lodz 1946, pp. 173-195.

⁴⁰ *Polish Charges against German War Criminals*, submitted to the United Nations War Crimes Commission by Dr. Marian Muszkat, Warsaw 1948. Treblinka is discussed on pp.

a sample we quote here an excerpt from the ‘experience report’ by witness Jan Sułkowski.⁴¹

“The Germans built a so-called ‘death-bridge’ which consisted of a scaffold 3-4 metres high. The German [Lampert] picked out some Jews and ordered them to climb on to the bridge. During the climbing the Jews were shot at. If there was a Jew who, by some miracle, succeeded in climbing right to the top he would be ordered to take off the shoes and to hold them over his head. This acrobatic trick was very difficult to perform as the whole scaffold was rocking. Then the Jew would be shot. I saw myself the SS men indulging in this ‘innocent’ game.”

Eyewitness Leon Finkelsztejn relates:⁴²

“Bilitz Alfred and Gens Adolf stood at the entrance to the gas chambers and cut women’s breasts off with long knives.”

Two further eyewitnesses, Hejnoch Brenner and Zygmunt Blacherski, had also seen how Bilitz cut off women’s breasts.⁴² – At the Jerusalem trial of John Demjanjuk, there was no more mention of Alfred Bilitz and Adolf Gens; it was the defendant Demjanjuk who was accused of having stood at the entrance of the gas chamber(s) and hacking off the breasts of women by choice with a dagger or a sword whenever he pleased.⁴³

After the appearance of this ‘documentation,’ there was a long period of silence insofar as the topic of Treblinka was concerned, and for a full 18 years indeed, no book, not even a noteworthy article, appeared about the camp. It was not until 1966, after the great Frankfurt Auschwitz trial, that eyewitnesses and chroniclers again announced their intention to be heard.

f. Jean-François Steiner

In 1966, the French-Jewish author Jean-François Steiner – with the assistance of the ghost-writer Gilles Perrault – published a novel⁴⁴ allegedly based upon the statements of former prisoners with the title *Treblinka*,⁴⁵ which represents a most particularly repulsive example of the copious gutter literature shaped by pathological fantasies about National Socialist concentration camps, but which has nonetheless been highly rated by prominent figures like Simone de Beauvoir.

187-196.

⁴¹ *Ibid.*, p. 194.

⁴² *Ibid.*, p. 195.

⁴³ See Chapter V.

⁴⁴ Steiner admitted 20 years after the first publication of *Treblinka* that his book amounts to a novel and that the novelist Gilles Perrault helped him with his written record (*Le journal du dimanche*, March 30, 1986). Reference from Robert Faurisson.

⁴⁵ Published by Librairie Arthème Fayard, Paris.

An English translation was published the following year under the title *Treblinka*.⁴⁶ A passage, in which Steiner describes the burning of bodies in Treblinka, may serve as a sample:⁴⁷

“Blonde and slight, with a gentle face and a retiring manner, he arrived one fine morning with his little suitcase at the gates of the kingdom of death. His name was Herbert Floss, and he was a specialist in the cremation of bodies. [...]

The first bonfire was prepared the next day. Herbert Floss then revealed his secret: all the bodies did not burn at the same rate; there were good bodies and bad bodies, fire-resistant bodies and inflammable bodies. The art consisted in using the good ones to burn the bad ones. According to his investigations – and judging from the results, they were very thorough – the old bodies burned better than the new ones, the fat ones better than the thin ones, the women better than the men, and the children not as well as the women but better than the men. It was evident that the ideal body was the old body of a fat woman. Floss had these put aside. Then he had the men and children sorted too. When a thousand bodies had been dug up and sorted in this way, he proceeded to the loading, with the good fuel underneath and the bad above. He refused gasoline and sent for wood. His demonstration was going to be perfect. The wood was arranged under the grill of the pyre in little piles which resembled camp fires. The moment of truth had come. He was solemnly handed a box of matches. He bent down, lit the first fire, then the others, and as the wood began to catch fire he walked back with his odd gait to the group of officials who were waiting a little way away.

The mounting flames began to lick at the bodies, gently at first, then with a steady force like the flame of a blow torch. Everyone held his breath, the Germans anxious and impatient, the prisoners dismayed and terrified. Only Floss seemed relaxed; very sure of himself, he was muttering abstractedly, ‘Tadello, tadello...’ The bodies burst into flames. Suddenly the flames shot up, releasing a cloud of smoke, a deep roar arose, the faces of the dead twisted with pain and the flesh crackled. The spectacle had an infernal quality and even the S.S. men remained petrified for a few moments, contemplating the marvel. Floss beamed. This fire was the finest day of his life.

When they had recovered from their stupor, the Germans gave expression to their joy and gratitude. Herbert Floss became a hero. An event like this had to be celebrated in a worthy manner. The Germans sent for tables, which were set up opposite the funeral pyre and covered with dozens of bottles of liquor, wine and beer. The dying day reflected the high flames of

⁴⁶ Jean-François Steiner, *Treblinka*, Simon and Schuster, New York 1967.

⁴⁷ *Ibid.*, pp. 352-355.

the funeral pyre, the sky glowed at the end of the plain where the sun was disappearing with a show of fire.

At a nod from Lalka, the corks popped. An extraordinary party began. The first toast was made to the Führer. The operators of the excavators had returned to their machines. When the S.S. men raised their glasses noisily, the excavators seemed to come to life and suddenly flung their long jointed arms toward the sky in a throbbing and jolting Nazi salute. It was like a signal; ten times the men raised their arms, each time shouting 'Heil Hitler.' The manlike machines returned the salute of the machinelike men, and the air rang with shouts of glory to the Führer. The party lasted until the funeral pyre was entirely consumed. After the toasts came the songs, savage and cruel, songs of hatred, songs of fury, songs of glory to Germany the eternal."

Even one hundred percent loyal advocates of the orthodox 'Holocaust' image have grasped that this sort of statement undermines the credibility of their position. Thus fourteen years later, the French Jew Pierre Vidal-Naquet, who in the beginning had expressed his "admiration" for Steiner's book,⁴⁸ suddenly spoke of "sub-literature" appealing to sadism and admitted that he had "walked into the snare set by J.-F. Steiner."⁴⁹ Another French critic, Didier Daeningckx, devastatingly described Steiner's book as "a false novel, which is presented as true" and which makes use of the "technique of parallel montage."⁵⁰

g. Krystyna Marczevska/Władysław Ważniewski

In 1968, an article appeared from the pens of two Polish historians, K. Marczevska and W. Ważniewski, on the Polish resistance movement's knowledge regarding Treblinka during the war.⁵¹ The reports of the resistance published here are most valuable indeed, as they help us in reconstructing how the official image of Treblinka evolved. We shall continuously refer to this in Chapter II.

h. Martin Gray

In 1971, the Polish-born French Jew Martin Gray published a book entitled *Au nom de tous les miens*⁵² (In the name of all of mine), in which he describes, *in-*

⁴⁸ "Treblinka et l'Honneur des Juifs," *Le Monde*, May 2, 1966. Reference from R. Faurisson.

⁴⁹ *Esprit*, September 1980. Reference from R. Faurisson.

⁵⁰ "De Treblinka à Bordeaux," *Revue de la Shoah*, May-August 1999. Reference from R. Faurisson.

⁵¹ Krystyna Marczevska, Władysław Ważniewski, "Treblinka w swietle Akt Delegatury Rządu RP na Kraji" (Treblinka in Light of the Documents of the Home Government Delegation of the Polish Republic) in: *Biuletyn Głównej Komisji Badania Zbrodni Hitlerowskich w Polsce*, Vol. XIX, Warsaw 1968, pp. 129-164.

⁵² Editions Robert Laffont, Paris. English translation: *For Those I Loved*, Boston, Little, Brown

ter alia, an alleged stay in Treblinka. Gray's ghostwriter was his co-religionist Max Gallo, who interviewed this 'Treblinka survivor' and put his statements down on paper. In his introduction, Gallo wrote:⁵³

"We saw each other every day for months. [...] I questioned him; I made tape recordings; I observed him; I verified things; I listened to his voice and to his silences. I discovered the modesty of this man and his indomitable determination. I measured in his flesh the savagery and barbarism of the century that had produced Treblinka. [...] I rewrote, confronted the facts, sketched in the background, attempted to re-create the atmosphere."

As fruit of the collaboration between Gallo and Gray, a book emerged with passages such as the following:⁵⁴

"Sometimes we found living children among the warm bodies. Little children, still alive, clinging to their mothers' bodies. We strangled them with our own hands before throwing them into the grave. And we risked our lives doing it because we were wasting time. The butchers wanted everything to happen fast."

After Gray had survived Treblinka and the war in a miraculous manner, he emigrated to the USA, where, as he relates in his book, he became wealthy from the sale of fake antiques. After the publication of the English version of his book, he was – according to Robert Faurisson – “suspected of fabricating false memoirs, just as he had produced false antiques, in both instances not without the help of others and naturally for money.”⁵⁵ Even anti-revisionist authors like the French Jew Eric Conan, who speaks of a work “well-known to all historians of this epoch as fraudulent,”⁵⁶ have castigated M. Gray's hack-work as a blatant falsification, but this does not change the fact that this unspeakable piece of trash – exactly like that of J.-F. Steiner – keeps reappearing in new editions in France and Germany.

i. Gitta Sereny

In 1974, the Hungarian-born British journalist Gitta Sereny published a book entitled *Into That Darkness*,⁵⁷ which is lauded to the present day as the standard work dealing with Treblinka.⁵⁸ Sereny visited the second commandant of Treblinka, Franz Stangl, in prison, interviewing him several times between April and June of 1971. Stangl had been sentenced to life imprisonment by a Düsseldorf court in 1970. Sereny's book is largely based on these interviews

1972. The English edition is cited subsequently.

⁵³ *Ibid.*, Max Gallo's Foreword, pp. ix-f;

⁵⁴ *Ibid.*, p. 139.

⁵⁵ Robert Faurisson, *Ecrits révisionnistes (1974-1998)*, private edition, 1999, Vol. I, p. 376.

⁵⁶ *L'Express*, February 27, 1997. Reference from R. Faurisson.

⁵⁷ McGraw-Hill, New York.

⁵⁸ As in the latest German version, *Am Abgrund*, Piper, Munich 1995.

(as well as on those with three other SS men who served at Treblinka during the war and with some former Jewish prisoners of the camp).

According to Gitta Sereny, Stangl confirmed the official picture of Treblinka in his conversations with her. But her book is totally worthless as an historical source, since the author cannot produce a trace of proof that Stangl actually made the statements ascribed to him; that is to say, a recorded protocol of the talks does not exist. On June 28, 1971, one day after Sereny's final visit, Stangl suddenly died under unexplained circumstances, and because no denial was to be expected from a dead man, the author of *Into That Darkness* was able to put into his mouth whatever pleased her.

The French revisionist Pierre Guillaume recalls a discussion conducted with G. Sereny, which he described as follows:⁵⁹

"After we had seated ourselves at the table, ordered drinks, and exchanged the usual empty civilities, this is the gist of what I said to Gitta Sereny: 'I have read your book more than once, and many passages even several times. On the first reading, one cannot doubt the truth of the statements as well as the reality of the confessions of Stangl. But the more often I went through the text, the greater became my amazement, first of all, less on the basis of what I was reading than on the basis of the obvious absence of that, which one would have expected to find. Lastly, with the repeated and very precise readings of the passages where Stangl 'confesses,' my amazement increased even more, for without exception they were written in indirect or ambiguous style, so that it became impossible to distinguish in these passages between what Stangl had said and what Gitta Sereny had said.' I made some significant facial expressions and then, quietly looking my conversational partner in the eye and giving emphasis to every single word, I said:

'In brief: he did not confess!'

'But of course not... he couldn't do it!'

Gitta Sereny was of the opinion that she had served a therapeutic and wholesome function with respect to Stangl, in that she was helping him to relieve his conscience by a confession, which was too terrible for him to have been able to make entirely alone. [...] Stangl, in fact, died suddenly in prison, very soon indeed after his 'confessions,' although he clearly enjoyed good health and had constantly denied the crimes imputed to him. He was awaiting his [appeal] trial, from which he – and his wife – were hoping for a favorable outcome."

We agree with Guillaume, word for word. On reading Gitta Sereny's book one does indeed feel "amazement on the basis of the obvious absence of that, which one would have expected to find": In this poor work of over 400 pages,

⁵⁹ Pierre Guillaume, "Les bonnes intentions dont l'enfer est pavé," in *Annales d'Histoire Révisionniste*, No. 5, Summer/Fall 1988, pp. 189f.

there is, to be sure, an abundance of stupefying psychological ruminations, yet not the slightest suggestion as to the practical process of the claimed mass murders in Treblinka, such as how the gas chambers functioned or how approximately 800,000 bodies were destroyed without a trace. How can one even imagine that a prisoner hoping for a successful appeal of his verdict would suddenly ‘admit’ to a journalist everything that he is denying in his application for appeal and which must inevitably destroy his hopes for a favorable ruling? The much-vaunted ‘standard work’ about Treblinka therefore turns out to be a brazen fraud!

j. Stanisław Wojtczak

In 1975, the Pole Stanisław Wojtczak wrote a long article, the English title of which is “The Penal and Labor Camp Treblinka I and the Extermination Center Treblinka II” and which contains a comprehensive collection of texts about this camp.⁶⁰ The work presents a detailed summary of the investigations performed by the Polish authorities. The author had entry to the archives of the Main Commission for the Investigation of Hitler Crimes in Poland, which represents the approximate counterpart to the *Zentrale Stelle der Landesjustizverwaltungen* (Central Office of the State Justice Administrations) in Ludwigsburg, Germany, and consolidates the entire documentation concerning various local judicial proceedings.

k. Adalbert Rückerl

A documentation with the title *NS-Vernichtungslager im Spiegel deutschen Strafprozesse* (National Socialist Extermination Camps in the Light of German Criminal Trials) appeared in 1977 in Germany,⁶¹ in which the criminal trials conducted by West German penal courts against former members of the camp staff of Treblinka, Sobibór, Belżec, and Chełmno are described. It was authored by Adalbert Rückerl, former director of the *Zentrale Stelle*. We will refer to this book several times.

l. Alexander Donat

In 1979 in the United States, Alexander Donat edited the anthology *The Death Camp Treblinka*. In addition to the aforementioned text by Rachel Auerbach already mentioned, which had appeared in 1946 in Yiddish and was now published for the first time in English as “The Fields of Treblinka”, this book also contained contributions by six other authors (Abraham Krzepicki, Jankiel

⁶⁰ Stanisław Wojtczak, “Karny obóz pracy Treblinka I i ośrodek zagłady Treblinka II,” in: *Biuletyn Głównej Komisji Badania Zbrodni Hitlerowskich w Polsce*, Warsaw 1975, XXVI, pp. 117-185.

⁶¹ Adalbert Rückerl, *NS-Vernichtungslager im Spiegel deutscher Strafprozesse*, German version, Frankfurt 1977.

Wiernik, Samuel Willenberg, Tanhum Grinberg, Shalom Cohen, and Samuel Rajzman). According to the introduction written by Donat himself, these reports were composed “without dramatization, embellishments, inventions, and hollow phrases.”⁶² Just how seriously this promise is to be taken is shown not only by the fact that the impossible horror report by R. Auerbach is reproduced without commentary; additionally and *inter alia*, a text of Jankiel Wiernik, which we shall discuss in detail later, is cited as a serious source. It claims:⁶²

“When corpses of pregnant women were cremated, their bellies would burst open. The fetus would be exposed and could be seen burning inside the mother’s womb.”

In a review that appeared in 1981 in the *Journal of Historical Review*, Horst Kehl had this to say about Donat’s anthology:⁶³

“If it is impossible to tear a child in half; [...] if it is impossible to cram people into half a square foot each; if it is impossible to use women as kindling and scoop up buckets of human fat; if it is impossible to leap over a 9 foot high fence; just what other parts of this saga are true?”

m. The Main Commission’s *Encyclopedic Informer*

Also in 1979, the Polish Main Commission for the Investigation of Hitler Crimes published an *Encyclopedic informer* on the camps and prisons existing on Polish soil during the German occupation. With respect to the camp Treblinka II, only the works of Wiernik, Grossmann, and Łukaszkiwicz are cited in the bibliography, aside from trial files, archive documents, and an article about the reports of the underground movement by Marczevska/Ważniewski.⁶⁴ This indicates that no book on Treblinka with any claim to a scientific method appeared between 1946 and 1979 in Poland, either.

n. Eugen Kogon, Hermann Langbein, Adalbert Rückerl *et al.*

In 1983, an authors’ collective directed by E. Kogon, H. Langbein, and A. Rückerl published *Nazi Mass Murder*. In the introduction, the authors rail against “those who [...] deny the killing of millions of victims by gas” and their alleged “desire to defend the Nazi system,” but specify neither authors nor titles. The fact that such deniers exist, the introduction goes on to say, “is sufficient to justify our intention to set down, in a precise and indisputable

⁶² In: A. Donat, *op. cit.* (note 4), p. 170.

⁶³ Horst Kehl, “‘Holocaust’ Pharmacology vs. Scientific Pharmacology,” in: *Journal of Historical Review*, Vol. 2, No. 1, Spring 1981, p. 95.

⁶⁴ Główna Komisja Badania Zbrodni Hitlerowskich w Polsce (ed.), *Obozy hitlerowski na ziemiach polskich 1939-1945. Informator encyklopedyczny*, Państwowe Wydawnictwo Naukowe, Warsaw 1979, p. 528.

manner, the historical truth.”⁶⁵ This “historical truth” is “set down, in a precise and indisputable manner” mainly by means of eyewitness testimony and confessions of alleged perpetrators. One Abraham Goldfarb is a leading witness for the claimed mass murders in Treblinka, and the editors cite him as follows:⁶⁶

“On the way to the gas chambers Germans with dogs stood along the fence on both sides. The dogs had been trained to attack people; they bit the men’s genitals and the women’s breasts, ripping off pieces of flesh. The Germans hit the people with whips and iron bars to spur them on, so that they would press forward into the ‘showers’ as quickly as possible. The screams of the women could be heard far away, even in the other parts of the camp. The Germans drove the running victims on with shouts of ‘Faster, faster, the water is getting cold, and others still have to take a shower!’ To escape from the blows, the victims ran to the gas chambers as quickly as they could, the stronger ones pushing the weaker ones aside. At the entrance to the gas chambers stood the two Ukrainians, Ivan Demaniuk⁶⁷ and Nikolai, one of them armed with an iron bar, the other with a sword. Even they drove the people inside with blows...

As soon as the gas chambers were full, the Ukrainians closed the doors and started the engine. Some twenty to twenty-five minutes later an SS man or a Ukrainian looked through a window in the door. When he had made sure that everyone had been asphyxiated, the Jewish prisoners had to open the doors and remove the corpses. Because the chambers were overcrowded and the victims had held on to one another, they were all standing upright and were like one single mass of flesh.”

Since witness statements like that clearly satisfied the authors, they did not make the least attempt to furnish material or documentary evidence for the claimed mass murder in Treblinka (or the other ‘extermination camps’).

o. Claude Lanzmann

In 1985, the nine-and-a-half-hour film *Shoah* debuted, shot by the French-Jewish director Claude Lanzmann. It sought to prove, on the basis of eyewitness narratives of ‘Holocaust survivors,’ the annihilation of the Jews in ‘extermination camps,’ among them also Treblinka. In the introductory note to the book of the same name, which contains the entire spoken text of the film, Simone de Beauvoir wrote:⁶⁸

⁶⁵ E. Kogon, H. Langbein, A. Rüdiger, *et al.* (eds.), *Nazi Mass Murder*, Yale University Press, New Haven 1993, pp. 1f.

⁶⁶ *Ibid.*, p. 126f.

⁶⁷ Correct spelling: Demjanjuk. See Chapter V.

⁶⁸ Claude Lanzmann, *Shoah*, éditions Fayard, Paris 1985; English edition, *Shoah*, DaCapo Press, New York 1995, Foreword, p. vii.

“After the war we read masses of accounts of the ghettos and the extermination camps, and we were devastated. But when, today, we see Claude Lanzmann’s extraordinary film, we realize we have understood nothing. In spite of everything we knew, the ghastly experience remained remote from us. Now, for the first time, we live it in our minds, hearts and flesh. It becomes our experience.”

In order to gain a notion of the standard of this film and of the book of the same title, we now reproduce an excerpt from the conversation in it between the director and his star eyewitness, the Treblinka barber Abraham Bomba. We are quoting here from the English translation:⁶⁹

“[Lanzmann:] How did it look, the gas chamber?

[Bomba] *It was not a big room, around twelve feet by twelve feet. [...] And then one of the kapos came in and said: ‘Barbers, you have to do a job to make all those women coming in believe that they are just taking a haircut and going in to take a shower, and from there they go out from this place.’ We know already that there is no way of going out from this room [...]*

And suddenly you saw the women coming?

Yes, they came in.

How were they?

They were undressed, naked, without clothes, without anything else [...]

There were no mirrors?

No, there were no mirrors. There were just benches – not chairs, just benches – where we worked, about sixteen or seventeen barbers [...]

You said there were about sixteen barbers? You cut the hair of how many women in one batch?

In one day there was about, I would say, going into that place between sixty and seventy women in the same room at one time. After we were finished with this party, another party came in [...]”

Robert Faurisson comments about this:⁷⁰

“This part of the witness account of Bomba can be summarized as follows: In a room of 16 square meters, there are sixteen (or seventeen?) barbers as well as benches; sixty or seventy naked women, along with children whose number is not more closely given, enter the room. [...] This is impossible. This is even pure nonsense. [...] Human gullibility knows no limits. Due to the brainwashing, the generations-long propaganda conducted against German or Nazi barbarism, one can swallow everything, one can succeed in having everything swallowed.”

⁶⁹ *Shoah*, English edition, pp. 112-116.

⁷⁰ R. Faurisson, *Ecrits révisionnistes*, op. cit. (note 55), Vol. II, pp. 558f.

p. Yitzhak Arad

In 1987, the Israeli ‘Holocaust expert’ Yitzhak Arad made an attempt to scientifically document the extermination of the Jews in Treblinka as well as in the other ‘eastern extermination camps’ in the book *Belzec, Sobibor, Treblinka. The Operation Reinhard Death Camps*. But even many footnotes are unable to disguise the fact that Arad’s claims of exterminations are based *exclusively* upon those eyewitness narratives whose worth we can easily appraise from the examples, which have been cited up to this point. Arad’s book, which today is generally considered to be the standard work about Treblinka as well as the other two ‘camps of Operation Reinhardt,’ contains blatant impossibilities. For example, Arad writes about the “old gas chambers” of the camp in this manner:⁷¹

“At the entrance to the gas chambers stood two Ukrainians, Ivan Demianuk and Nikolai, one armed with an iron bar and the other with a sword, and they, too, urged the people on with blows to push their way in – 200-250 in a chamber of 16 square meters. [...]

There were instances when the gas chambers were opened too early and the victims were still alive; the doors would have to be closed again. The engines that produced and fed the gas into the chambers also broke down, causing stoppages in the extermination operation. Breakdowns of this nature also occurred when the victims were already inside the gas chambers, and they would then be held there for long hours until the engines had been repaired.”

Under the unrealistic assumption that it was possible to pen up 200 to 250 people in a chamber sixteen square meters in size (and 2.6 m high⁷²) without fresh air, the pitiable victims would certainly not have had to wait out “long hours” when there were engine breakdowns, since they would have suffocated a long time before that; one would therefore have been able to do without the engine.

We will return to this and to other technical impossibilities in another chapter.⁷³ We will also discuss the brazen falsification of source material undertaken by Arad.⁷⁴

q. Ryszard Czarkowski

In 1989, a book appeared in Poland entitled *Cieniom Treblinka* ([dedicated to] The Shadows of Treblinka). The author, a Ryszard Czarkowski, had been interned in the labor camp Treblinka I during the war, barely three kilometers

⁷¹ Yitzhak Arad, *Belzec, Sobibor, Treblinka. The Operation Reinhard Death Camps*, Indiana University Press, Bloomington and Indianapolis 1987, p. 86f.

⁷² According to Arad, the gas chambers were that high (*ibid.*, p. 42).

⁷³ See Chapter IV.

⁷⁴ See Chapter II.

from the ‘extermination camp’ Treblinka II. According to the introduction to this work, the prisoners of the labor camp were able to observe the process of mass murders in the adjacent ‘extermination camp,’ since “there were contacts of labor between the two centers.”⁷⁵

Czarkowski criticizes Z. Łukasziewicz because of the number of Treblinka victims, 800,000, given by the latter; by means of eyewitness narratives as well as some counts of the deportation trains, he determines the number of murdered to be 1,582,000.⁷⁶

The question of how 1,582,000 bodies might have been disposed of without a trace evidently gives him as little occasion for reflection as does the question of why Stalinist Polish historiography and judiciary during the post-war years should have reduced the number of Treblinka victims to half of what he claims to be true, and thus scandalously minimized National Socialist crimes.

r. J. Gumkowski and A. Rutkowski

The work *Treblinka*,⁷⁷ written by J. Gumkowski and A. Rutkowski, has no date, but it can be said with certainty that it appeared after the aforementioned books by Y. Arad and R. Czarkowski. It is of definite value, since it contains a selection of documents and photographs from the archives of the Main Commission for the Investigation of Crimes against the Polish People (formerly the Main Commission for the Investigation of Hitler Crimes in Poland).

s. Wolfgang Benz

In 1991, an authors’ collective directed by Wolfgang Benz published the anthology *Dimension des Völkermords* (Dimension of Genocide) in response to the demographic study *The Dissolution of Eastern European Jewry* by Walter Sanning,⁷⁸ which had appeared eight years earlier and according to which the total losses of Jewry in the areas controlled by Germany during the Second World War amounted only to several hundred thousands. Benz and his co-authors defend the usual figure of about six million Jewish victims. With respect to Treblinka, Benz repeats the number of victims given by Rachel Auerbach in 1946 – 1,074,000 – since this “seems more realistic to us than the demonstrable minimum number.”⁷⁹ That the authors’ collective classifies Rachel

⁷⁵ Ryszard Czarkowski, *Cieniom Treblinki*, Wydawnictwo Ministerstwa Obrony Narodowej, Warsaw 1989, p. 5.

⁷⁶ See Chapter III.

⁷⁷ J. Gumkowski, A. Rutkowski, *Treblinka*, published by the Council for Protection of Fight and Martyrdom Monuments, Warsaw, without date.

⁷⁸ Walter Sanning, *The Dissolution of Eastern European Jewry*, I.H.R., Torrance 1983 (2nd ed., Castle Hill Publishers, Uckfield 2015).

⁷⁹ Wolfgang Benz (ed.), *Dimension des Völkermords. Die Zahl der jüdischen Opfer des Nationalsozialismus*, R. Oldenbourg Verlag, Munch 1991, p. 468.

Auerbach's work, according to which blood in Treblinka proved to be "first-class combustion material," as a serious source, already says much about the quality of this collection. Germar Rudolf, who compared the works of Sanning and Benz and has demonstrated the blatant demographic manipulations of the Benz team, comments in this regard:⁸⁰

"Thus, Treblinka with its more than one million victims is weighted more heavily in Benz's analysis than Auschwitz is – a completely new trend in Holocaust studies."

As Rudolf correctly points out, this elevation of the number of Treblinka victims serves the purpose of enabling the sacrosanct six million figure to be maintained despite the drastic lowering of the number of victims of Auschwitz that has occurred in recent years.

t. Richard Glazar

In 1992, forty-nine years after the dissolution of Treblinka, the Jew Richard Glazar published his 'eyewitness narrative' *Trap with a Green Fence*. Although, according to the official version of Treblinka summarized in the *Encyclopedia of the Holocaust*, the Jewish prisoners "were killed after working in the camps for several weeks or months, to be replaced by new arrivals from the transports,"⁸¹ Glazar by his own account spent a full ten months in that camp, from October 1942 until August 1943. His account of his 'personal experiences' is a plagiarism cobbled together from diverse tales of other 'Treblinka survivors.' One of the sources, from which he took his inspiration, is a 1986 book by Samuel Willenberg, first published in Hebrew and then in English in 1989. There, for example, one reads about the Greek Jews who arrived in Treblinka in the spring of 1943:⁸²

"Early in spring of 1943 the whistle of a train heralded the arrival of a new shipment. A slightly strange crowd spilled out – people with dark faces, curly, raven-black hair, and a foreign tongue on their lips. The suitcases taken out of the wagons bore labels reading 'Saloniki'. Word that Jews from Greece had arrived spread around the camp like lightning. [...] Every last one of them exited the cars in a state of total calm. [...] The SS man] Mitte found three Greeks with a command of German and drafted them as interpreters."

In Glazar's book, this is described as follows:⁸³

⁸⁰ Germar Rudolf, "Holocaust Victims: A Statistical Analysis · W. Benz and W. N. Sanning – A Comparison," in: Germar Rudolf (ed.), *Dissecting the Holocaust*, 3rd ed., Castle Hill Publishers, Uckfield 2019, pp. 175-206, here p. 196.

⁸¹ *Encyclopedia of the Holocaust*, *op. cit.* (note 18), as cited on p. 16.

⁸² Samuel Willenberg, *Revolt in Treblinka*, Żydowski Instytut Historyczny, Warsaw 1989, pp. 104f. Almost identical (the SS man is called Miete, though): Samuel Willenberg, *Surviving Treblinka*, Basil Blackwell, Oxford/New York 1989, p. 113.

⁸³ Richard Glazar, *Trap with a Green Fence*, Northwestern University Press, Evanston, IL,

“People climb calmly out of the cars, without pushing, without crowding. [...] Apparently they have been in quarantine too. [...] Their faces look healthy, and they have an unusual dark complexion. Black hair – all I see black to pitch-black hair. [...] I can hear that the people are speaking a completely foreign language.”

“Three were chosen from this transport. [...] They can speak a little, a very little German. Through them the others were informed that everything had to be disinfected, that they would go to a bath to be disinfected, and then they would be sent to work.”

The author makes two colossal blunders: First he has the burning of the bodies begin “one overcast November afternoon” in 1942,⁸⁴ although the standard literature unanimously claims that the incineration of corpses did not start before March/April 1943. Next he claims that he was part of Treblinka’s “camouflage commando”:⁸⁵

“There are a few here, until now the only ones, who have been allowed to work in contact with nature, to see the camp of death from the outside, [...] when they are driven out of the camp and into the forest, when they break branches off pine trees and collect them, [...]. But in the camouflage commando they only keep workers who are fit enough to climb high up into the trees and trot back to camp carrying heavy bundles of branches. They weave these branches into strands of barbed wire, thus maintaining the camouflage green around the entire perimeter of the camp.”

“The camouflage unit is the only one of the old work squads that still has enough real work to do. There is so much exterior and interior fencing that there are always repairs to be made. And if there are no repairs, then the camouflage unit is well suited for the forestry work in the vicinity of the camp – for clearing and cutting. Several times a day [...] some part of the twenty-five man unit has to go out into the forest, climb into the trees, harvest large branches, and carry them back into the camp, where they will be used for repairs. The other part of the unit straightens and firms up the posts, tightens the barbed wire, and weaves the new pine boughs into the fence until there are no longer any gaps in the dense green wall. [...] We are the camouflage unit. [...]

From climbing into the trees and breaking off branches, Karl and I have scratches on our hands and faces.”⁸⁶

Thus, according to Richard Glazar, 25 inmates were the only ones in Treblinka who were able to leave the camp, to work in the forests, to do real hard work, and to supply the camp with its needs of wood. If there had ever been a

1995, p. 89, 93.

⁸⁴ *Ibid.*, p. 29.

⁸⁵ *Ibid.*, p. 56.

⁸⁶ *Ibid.*, pp. 127f.

massive need for firewood in Treblinka to cremate corpses, filled by inmates sent into the forests to fell trees, these activities would have yielded millions of branches, which would have rendered the tree-climbing activities of the camouflage unit obsolete.⁸⁷ But apparently Glazar opines that no such tree-felling occurred during his time in the camp. All Glazar, the lumberjack of Treblinka, knows about how the corpses were allegedly incinerated is the following:⁸⁴

“You have to build big bonfires and put a lot of kindling in among the corpses, and then douse the whole thing in something very flammable.”

u. Jean-Claude Pressac

In 1995, the French magazine *Historama* published an article by Jean-Claude Pressac,⁸⁸ a researcher who, to be sure, considered the gas chambers to be an historical fact but who – in comparison with the other representatives of the official version of history – clearly maintained a relatively critical attitude toward witness testimonies. In his contribution, Pressac was chiefly concerned with Auschwitz, but he also looked into the subject of Treblinka, Sobibór, and Bełżec. In contrast to the conventional historiography, according to which these camps were set up exclusively for the extermination of Jews, Pressac opines that they were originally established as transit or as delousing camps and were only later converted into extermination camps. We shall examine this thesis of Pressac more closely in another chapter.⁸⁹

Likewise in 1995, Pressac granted an interview to Valérie Igounet, which was not published until 2000, with changes made according to Pressac’s wishes. In it, Pressac denounced the official account of the concentrations camps as being distinguished by “bungling, exaggeration, omission, and lies,”⁹⁰ and he determined that to call the National Socialist policy against the Jews ‘genocide’ is erroneous.⁹¹ He also posited a drastic reduction in the number of victims in the ‘pure extermination camps,’ among them Treblinka.⁹²

v. Assessment

After what has been said to this point, our judgment with respect to the picture of the camp drawn by the orthodox historians must be a devastating one: the few works that proceed scientifically support their claims, without exception, with unreliable sources; the bunglings of brazen liars are accepted as classics

⁸⁷ See Chapter IV.12.f. for details. Even if such a camouflage unit had existed, it surely would have chopped down the trees, then cut the branches off, rather than shinnying up the tree trunks. Such an activity is ridiculous.

⁸⁸ J.-C. Pressac, “Enquête sur les camps de la morte,” in: *Historama*, No. 34, 1995.

⁸⁹ See Chapter IX.

⁹⁰ Valérie Igounet, *Histoire du négationnisme en France*, Editions du Seuil, Paris 2000.

⁹¹ *Ibid.*, p. 641.

⁹² See Chapter III.

of the Treblinka literature. In short: the value of the official historiography on the camp is pitifully small!

2. Treblinka in Revisionist Literature

a. Treblinka and the Gerstein Report

Because the official historiography of the ‘Holocaust’ has from the very beginning focused upon Auschwitz, the revisionists, who had to confront their opponents on the field chosen by the latter, have likewise concentrated quite predominantly upon the concentration camp Auschwitz and devoted significantly less attention to Treblinka.

Treblinka was at least touched upon by some revisionist authors in connection with the so-called ‘Gerstein Report.’ The alleged confessions of the SS officer Kurt Gerstein, who according to his ‘confessions’ visited Belżec and Treblinka in the year 1942, are considered to be one of the supporting pillars of the ‘Holocaust.’ In Belżec, Gerstein purports to have attended a mass gassing, the description of which, however, abounds in impossibilities: thus, he claims that in the gas chamber 700 to 800 victims were crammed together in “25 square meters, in 45 cubic meters”!

The Frenchman Paul Rassinier, former resistance fighter, prisoner in the concentration camps Buchenwald and Dora-Mittelbau, and the founder of Revisionism, pointed out the unreliability of the Gerstein Report in his 1964 book *Le Drame des Juifs Européens*⁹³ and stressed its worthlessness as an historical source. Another French researcher, Henri Roques, has proved in his 1989 doctoral dissertation that not fewer than six versions of the Gerstein Report exist, differing substantially from one another.⁹⁴ However, since Gerstein described a gassing event in Belżec and not in Treblinka, the studies of Rassinier and Roques demolish above all the credibility of his statements about the former camp. In contrast to the two French historians, Carlo Mattogno has dealt more in depth with Treblinka in his 1985 work *Il rapporto Gerstein, Anatomia di un falso*, which is also devoted to the Gerstein Report. In it, Mattogno suggested that “the myth of the gas chambers prevailed only somewhat” regarding Treblinka, because in 1943, in the *Black Book of Polish Jewry*, steam chambers for the extermination of the Jews were spoken of, and the same method of killing was still mentioned in the December 1945 Nuremberg Document PS-3311, produced by the Polish government. Only in Febru-

⁹³ Paul Rassinier, *Le drame des juifs européens*, Les sept couleurs, Paris 1964.

⁹⁴ Henri Roques, “Les confessions de Kurt Gerstein, étude comparative des six versions,” in: André Chelain, *La thèse de Nantes et l’affaire Roques*, Polémiques, Paris 1988.

ary 1946, according to Mattogno, did the Jewish witness Samuel Rajzman speak of gas chambers before the Nuremberg Court.⁹⁵

To date, four revisionist authors have led a massive assault against the foundations of the official picture of Treblinka: Friedrich P. Berg, John C. Ball, Udo Walendy, and Arnulf Neumaier, of whom the first two authors have investigated important individual aspects of the question, while the latter two have made a comprehensive attack upon the current version of Treblinka.

b. Friedrich P. Berg

In 1984, the graduate engineer F.P. Berg published a pioneering article in the *Journal of Historical Review* entitled: “The Diesel Gas Chambers: Myth within a Myth,”⁹⁶ in which he subjected the diesel engine, claimed as a murder weapon for Treblinka, Sobibór, and Bełżec, to technical and toxicological examination. An expanded German translation appeared in 1994 in the anthology *Grundlagen zur Zeitgeschichte*.⁹⁷ In the English edition of that work, *Dissecting the Holocaust*, (latest edition: 2019), Berg’s contribution appeared in a further revised and improved version.⁹⁸

In his study, Berg proved that diesel exhaust gases are appallingly ill adapted for the mass killing of human beings due to their high oxygen content and their very low carbon monoxide (CO) content; a gasoline engine would be far more efficient. We shall return to this topic in connection with the critique of witness testimonies in Chapter IV.

Berg’s study shook the current version of Treblinka, Sobibór, and Bełżec to its very foundations. If the Germans had really succeeded in gassing approximately 1.72 million Jews⁹⁹ in these three camps in record time and in removing all trace of their bodies, they would have to have been technical geniuses, and such geniuses would certainly not have resorted to so inefficient a murder weapon. The objection that perhaps the instrument of the crime was a gasoline engine is untenable, for the witnesses to the gassing claim that the exhaust gases had been produced by the engines of captured Russian tanks, and most Russian tanks of the Second World War were driven by diesel engines. The updated German edition of the *Encyclopedia of the Holocaust* maintains, plainly and clearly:¹⁰⁰

⁹⁵ Carlo Mattogno, *Il rapporto Gerstein, Anatomia di un falso*, Sentinella d’Italia, Monfalcone 1985, pp. 167ff.

⁹⁶ *Journal of Historical Review* 5 (1), 1984, pp. 15-46.

⁹⁷ Friedrich P. Berg, “Die Diesel-Gaskammern: Mythos im Mythos” in: E. Gauss (ed.), *Grundlagen zur Zeitgeschichte*, Grabert Verlag, Tübingen 1994, pp. 321-345.

⁹⁸ Friedrich P. Berg, “Diesel Gas Chambers: Ideal for Torture – Absurd for Murder,” in: G. Rudolf (ed.), *op. cit.* (note 80), pp. 431-475.

⁹⁹ According to the *Encyclopedia of the Holocaust* (note 18) 870,000 in Treblinka, 600,000 in Bełżec and 250,000 in Sobibór.

¹⁰⁰ Eberhard Jäckel, Peter Longerich, Julius H. Schoeps (eds.), *Enzyklopädie des Holocaust. Die*

“Bełżec, Sobibór, and Treblinka were built within the framework of the Operation Reinhardt[sic!] (so called from June of 1942) of the murder campaign against, above all, the Jews from the General Gouvernement. These extermination camps used carbon monoxide gas, which was produced by diesel engines.”

Whoever may object that the witnesses might have erred in regard to the weapon of the crime is simultaneously discrediting, along with the credibility of the witness testimony, the entire picture of the ‘eastern extermination camps,’ which is based *exclusively* upon just these witness statements!

c. John C. Ball

No less important than the technical and toxicological investigations of Berg are the analyses of Allied and German photographs taken during the war over the ‘extermination camps,’ among them Treblinka. These analyses were performed by the Canadian mineral-exploration geologist John C. Ball and presented in 1992 in his book *Air Photo Evidence*.¹⁰¹ We will also return to these photographs.

d. Udo Walendy

The German political scientist Udo Walendy, editor and publisher of the German historiographical series *Historische Tatsachen* (Historical Facts), has dealt with Treblinka in two issues of this periodical. No. 12 (1982) analyzes, *inter alia*, the 1964–1965 Düsseldorf trial of former members of the staff of

Verfolgung und Ermordung der europäischen Juden, 3 vols., Argon Verlag, Berlin 1993, entries for “Aktion Reinhard,” Vol. 1, p. 15: “Benzin oder Dieselmotoren” (gasoline or diesel engines); “Bełżec”, Vol. 1, p. 176: “Dieselmotor mit 250 PS” (diesel engine with 250 hp); “Sobibor”, Vol. 3, p. 1332: “200 PS-Motor” (200 hp engine); “Treblinka”, Vol. 3, p. 1428: “Dieselmotor” (diesel engine); “Gaskammer” (gas chamber), Vol. 1, p. 505: “Dieselauspuffgas [...] in den Vernichtungslagern im Generalgouvernement” (diesel exhaust gas... in the extermination camps in the General Gouvernement); and “Vernichtungslager” (extermination camps), Vol. 3, p. 1496: “These extermination camps [Bełżec, Sobibór, Treblinka] used carbon monoxide gas produced by Diesel engines.” According to this source, the Sobibór Camp (250,000 victims) is the only case where there is any uncertainty regarding the engine type. In Bełżec (600,000 victims) and Treblinka (700,000 to 1,200,000 victims) they were definitely diesel engines; the entries of English version of this *Encyclopedia* are identical for the individual camps, for “gas chamber,” and for “Aktion Reinhard” (AR: Vol. 1, p. 16; B: Vol. 1, p. 175; GC: Vol. 2, p. 540; S: Vol. 3, p. 1375; T: Vol. 3, p. 1483), but the entry for “extermination camps” says “gasoline or diesel engine”, Vol. 2, p. 462. The gasoline engine was apparently edited out by the German editors to conform to witness statements and court findings, but they neglected to remove it from the “Aktion Reinhard” entry.

¹⁰¹ John C. Ball, *Air Photo Evidence*, Ball Resource Services, Delta, B.C. 1992; more recently: Rudolf, Germar (ed.), *Air-Photo Evidence*, 6th ed., Castle Hill Publishers, Uckfield 2020. An abridged version appeared in: Germar Rudolf (ed.), *Dissecting the Holocaust*, *op. cit.* (note 80), pp. 263-277.

the Treblinka Camp.¹⁰² In it, Walendy pointedly attacks the legal basis of this trial and exposes numerous absurdities in the arguments supporting the verdict. We reproduce an excerpt from his commentary here.¹⁰³

“50 SS men manage, with the assistance of a tank engine, to kill approximately 700,000 people within a year and to remove all traces. That is 14,000 per SS guard, or just 40 per day, a total for all 50 of 2,000 per day. But wait: according to other claims [...], it was supposed to be 8,000 or 30,000 daily! Note well: per day!

With all this, these people still had time to pause for sadistic atrocities and continually invent new ones, with or without riding crops. To be sure, the normal life of the camp broke down, but obviously everything functioned, from the disinfection of the women’s shorn hair, to the separation of the Stars of David from the clothing, from the burning of the bodies, which had already been buried in large mass pits, to the total elimination of all traces, including sifting the ashes, crushing of the bones, and mixing the ashes with the soil as well as leveling the whole camp. [...] Neither attorneys nor experts, jurors, judges, ‘historians,’ or newspaper writers have burdened themselves with worrying about any of the technical impossibilities that are becoming obvious here – and add to this in the midst of war with a 50-man German guard detachment .”

Issue No. 44 of the *Historische Tatsachen*, which appeared eight years later, was devoted exclusively to the Treblinka Camp and thus was titled “Der Fall Treblinka” (The Case of Treblinka).¹⁰⁴ Walendy began by citing passages from W. Grossmann’s grotesque writing *Die Hölle von Treblinka* (The Hell of Treblinka) and subsequently dealt with the following topics:

- the claims of the *Black Book*, published in 1946 by the World Jewish Congress, that three million people had been murdered in Treblinka by means of “assembly-line execution”;
- the contradictions in the standard literature regarding the topographical information given about Treblinka, as well as between the various sketches produced by ‘eyewitnesses’;
- the lack of credibility of witness statements;
- an analysis of air photographs refuting extermination claims.

No. 44 of the *Historische Tatsachen* represented the most thorough and comprehensive critique of the orthodox Treblinka version to that point. In gratitude for his efforts to discover the historical truth, Walendy was later locked up for over two years in a German jail.¹⁰⁵

¹⁰² “‘NSG-Prozeß’ Treblinka” in: *Historische Tatsachen* No. 12 (“Das Recht, in dem wir leben”), Vlotho 1982, pp. 28-32.

¹⁰³ *Ibid.*, p. 30.

¹⁰⁴ *Historische Tatsachen* No. 44, “Der Fall Treblinka”, Vlotho 1990.

¹⁰⁵ Cf. *Vierteljahreshefte für freie Geschichtsforschung*, 1(2) (1997), p. 126, and 2(4) (1998), p.

e. Arnulf Neumaier

Since the official Treblinka version stands or falls with the possibility of the elimination of the bodies without a trace in the method and manner asserted by the witnesses, Neumaier's calculations in this regard are especially important.

In 1994, in the anthology *Grundlagen zur Zeitgeschichte*, appeared an outstanding article entitled "Der Treblinka-Holocaust," written by the graduate engineer Arnulf Neumaier.¹⁰⁶ A translation with the title "The Treblinka Holocaust" is included in the English version of the same book.¹⁰⁷ In his article Neumaier subjected the technical prerequisites for the claimed extermination of Jews in Treblinka to a comprehensive examination. He raised Berg's arguments against the viability of the alleged mass murder by means of diesel exhaust, and advanced additional points; demonstrated the massive contradictions of the witness statements, which name several entirely different methods of killing; and, in particular, considered the question of how the bodies were disposed.

f. The Thesis of the Transit Camp

The revisionist studies mentioned to this point have restricted themselves exclusively to refuting the official picture of Treblinka as an "extermination camp." An alternative interpretation of its function has not appeared in these studies, which of course is the direct consequence of the complete lack of contemporary documents. Yet some notable revisionist authors have proposed the thesis that Treblinka was a transit camp for Jews. The American scholar Prof. Dr. Arthur R. Butz suggested in his revisionist classic *The Hoax of the Twentieth Century*, first published in 1976, that Treblinka simultaneously served as a labor camp as well as a transit camp for Jews resettled to the east;¹⁰⁸ Prof. Dr. Robert Faurisson also supports the transit camp thesis.¹⁰⁹

Finally, the American historian Mark Weber, together with the U.S. lawyer Andrew Allen, wrote an excellent article about Treblinka in 1992, in which the two authors summarized all known arguments to that date against the 'extermination camp' thesis, introduced new viewpoints, and wrote concerning the actual nature of the camp:¹¹⁰

327; all in all, U. Walendy spent 29 months in prison.

¹⁰⁶ Arnulf Neumaier, "Der Treblinka-Holocaust," in: Ernst Gauss (ed.), *op. cit.* (note 97), p. 347-374.

¹⁰⁷ In: Germar Rudolf (ed.), *Dissecting the Holocaust*, *op. cit.* (note 80), pp. 475-508.

¹⁰⁸ Arthur R. Butz, *The Hoax of the Twentieth Century*, 4th ed., Castle Hill Publishers, Uckfield 2015, pp. 279f.

¹⁰⁹ Robert Faurisson, *Ecrits révisionnistes*, *op. cit.* (note 55), pp. 754f. (Vol. II).

¹¹⁰ Mark Weber, Andrew Allen, "Treblinka," in: *Journal Historical Review*, 12(2), Summer 1992, p. 139.

“If Treblinka was not an extermination center, what was it? [...] the balance of evidence indicates that Treblinka II – along with Belzec and Sobibor – was a transit camp, where Jewish deportees were stripped of their property and valuables before being transferred eastwards into German-occupied Soviet territories.”

Since Treblinka was much too small to be able to accommodate the large number of Jews deported there at the same time, the transit camp thesis is, in fact, the single plausible alternative to the conventional picture of the extermination camp. *Tertium non datur* – there is no third possibility.

Chapter II: The Development of the Idea of Treblinka as an Extermination Camp

1. The Secondary Killing Methods

As we have seen in the introduction, there was little secret about Treblinka. In fact, detailed reports about this camp were reaching Warsaw as early as August 1942. These were essentially coming from Jews who had fled from Treblinka, from people residing in the area surrounding the camp, and from the Polish railway workers who operated the trains with the deportees. In these reports the version of the mass murders adopted shortly after the war by the official historiography and still accepted today – gassing by means of the exhaust fumes of diesel engines – played a very negligible role. It appears in only two reports, which, moreover, mention undefined “toxic fluids” supposedly mixed with the exhaust gases.

On October 5, 1942, the Polish underground newspaper *Informacja bieżąca* (Current Information) circulated the following report:¹¹¹

“Treblinka. The death camp is once more in operation. Transports arrive from the entire country (most recently Radom, Siedlce, Międzyrzec). At present 10 trains, rather than 20, are allowed to approach at a time, for it takes a long time until the bodies of those who died on the way (20-30%) have been unloaded. The gas chambers function as follows: Outside of the barracks is a 20 HP internal combustion engine, which is in operation around the clock. The end of its exhaust pipe is mounted in a wall of the barracks; the exhaust gases, with the admixture of toxic fluids,^[112] which have been specially mixed into the fuel of the engine, kill the people locked up in the barracks. Besides the Jewish workers, there is a Jewish orchestra as well as a group of Jewish women in the camp area with whom the staff enjoys itself.

Up to the end of August, 320,000 Jews were exterminated in Treblinka.”

¹¹¹ Krystyna Marczevska, Władysław Ważniowski, *op. cit.* (note 51), pp. 138f.

¹¹² In the original: “z domieszką plynów trujacych.”

The killing method described here also surfaces in a report, which was forwarded to the Polish exile government in London as part of a series of reports about Treblinka:¹¹³

“After the arrival in the camp, the Jews receive the order to completely undress, under the pretext that they are being led to a bath. They are brought into a sealed chamber, a barrack, approximately 100 people at a time. Outside of the barrack stands an internal combustion engine of 20 HP, which runs around the clock. The mouth of the engine’s exhaust leads through the barrack’s wall, and the people locked up in the barrack are killed by exhaust gases channeled through it that contain toxic fluid additives, which have been especially mixed with the engine fuel.”

Other murder techniques are also described in the reports of the Polish underground movement. Thus, in an edition of *Informacja Bieżąca* dated August 17, 1942, a mobile gas chamber is discussed:¹¹⁴

“After the departure of the steam engines, the Jews are forced to undress, supposedly for the bath; then they are led into the gas chamber and executed, whereupon they – sometimes still living – are buried in excavated pits. The pits are excavated by machine; the gas chamber is mobile and moves back and forth over the pits. The camp strength amounted to 40,000 Jews on August 5, about 5,000 are executed daily. The liquidation is carried out by Ukrainians under the leadership of SS men. The operation in the Warsaw Ghetto is supposed to be completed by September of this year.”

On September 8, 1942, the *Informacja Bieżąca* reported on the deployment of an undefined gas with a delayed effect:¹¹⁵

“The extermination of the Jews takes place entirely independently from the events in the camp. The steam engine pushes the cars with the Jews under the ramp, all in sequence. The Ukrainians pull the Jews out of the cars and lead them to the ‘bath’ in the bathhouse. This is a building surrounded by barbed wire. They enter in groups of 300 to 500 persons. Each group is immediately locked up hermetically and gassed. Of course, this gas is not immediately effective, for the Jews have to walk to the pits afterwards, which are about ten to twenty meters away and 30 m deep. There they lose consciousness and fall into the pits, and the excavator sprinkles a thin layer of earth upon them. Then the next group follows.”

A further method was a gas – again without further description – with immediate effect. A Polish officer reported this: he had been sent to Treblinka with his Jewish wife on September 6, 1942, but escaped from there a few days af-

¹¹³ Krystyna Marczevska, Władysław Ważniewski, *op. cit.* (note 51), p. 153.

¹¹⁴ *Ibid.*, pp. 136f.

¹¹⁵ *Ibid.*, pp. 137f.

terward. His report belongs to the series of reports, which was sent to the Polish government-in-exile in London on March 31, 1943:¹¹⁶

“Outside of the barracks the women undressed completely, and together with the naked children they were led to the huge barracks of ‘Treblinka II’ through a side exit on a path, which was surrounded on both sides by a wire net. One supposedly takes a bath in these barracks, but in reality a sudden death by gas occurs. I do not know what kind of gas is used, but I know from a colleague who worked three weeks in ‘Treblinka II’ that the corpses have a bluish color. [...] I do not know how many people have been killed in Treblinka; the piles of clothes and shoes are enormous and attain a height of two stories; they take up a huge surface. [...] At the head of the group of Jewish workers are a Jew, the commandant of the camp, and his deputy. [sic!]”

In the same series of reports, one reached London that likewise spoke of an extermination of Jews in “gas chambers.” Information about what sort of gas was in use was not provided, but there are supposed to have been “about a hundred gas chambers” (!):¹¹⁷

“In this gigantic wooden house, where there were approximately 10,000 people in standing positions, an SS officer greeted them very politely and said the following, word for word: ‘You have worked too little up to now for the German State, and because of this the German Reich has decided to resettle you in the Ukraine, so that you work more. You are in a transit camp here. You will proceed directly to the bath.’ [...] They finally reach their destination – apparently baths, but in reality gas chambers. They walk, a few of them at a time, into one chamber, and there are certainly about a hundred of these chambers. [...] The bodies are piled up in even layers, a hundred at a time, and chlorine is sprinkled on them.”

Among the reports delivered to London on March 31, 1943, was one entitled “*Charakterystyka metod Treblinki*” (Characteristic of the Methods of Treblinka), in which three further murder methods were listed: shooting, trains with unslaked lime, and water vapor:¹¹⁸

“At the beginning of the so-called resettlement operation, when the technical preparations of the machinery of death were still not perfected, the Germans killed their victims in Treblinka in an extremely simple manner: a machine gun opened fire upon a crowd of men, women, and children who were brought forward, and they were shot down, each and every one of them. A crew of gravediggers threw all – the bodies of those killed, the critically wounded, as well as those lightly wounded – into the pits prepared up to that time and strew them over with earth.

¹¹⁶ *Ibid.*, p. 148.

¹¹⁷ *Ibid.*, p. 151.

¹¹⁸ *Ibid.*, pp. 153f.

In August as well as the following months, as the acceleration of the campaign exceeded the possibilities of the steam chambers, the transports were loaded into cars, which were sprinkled with a layer of lime and chlorine, so that after the arrival in Treblinka, only corpses of a violet-blue color were tossed out of the cars. All had suffocated under torment in the cars. For these transports (for example from Międzyrzec Podl., Kielce) Treblinka was but the place of burial. From this information it emerges that a punctual and precise execution of the determined plan was important to the Germans. The methods described above were practiced when the capacity of the machinery of death in Treblinka was faltering. The teeth of the corpses pulled out of the steam chambers in Treblinka were examined. Gold teeth and bridges were extracted by means of dental instruments.”

In 1946, Eugen Kogon cited in his well-known book *Der SS-Staat* the eyewitness narrative – originating from the previous year – of one Oskar Berger, who, according to his own statements, had been deported in July 1942 from the ghetto of Kielce to Treblinka and had escaped in September of the same year. He stated *inter alia*:¹¹⁹

“Sometimes there were shipments that held only corpses. I believe these people must have been gassed in the cars, for I never noticed any wounds.”

He added that in the beginning the Jews who had arrived in the camp were shot. During his stay in Treblinka, the Germans had built “a small brick building.”¹²⁰ From then on, according to the witness, “new arrivals were gassed rather than shot.”

These killing techniques – engine exhaust fumes from fuel mixed with toxic fluids, stationary gas chambers, a mobile gas chamber, gas with a delayed effect, gas with immediate effect, shootings, train cars strewn with unslaked lime, electric current¹²¹ – were mentioned in the reports about Treblinka only sporadically and without further details. The murder method that occupied the foreground, which was described most often as well as in the most detail, was scalding with steam.

2. The Main Killing Method: Steam Chambers

On October 15, 1942, Emmanuel Ringelblum noted in his “ghetto chronicle”:¹²²

¹¹⁹ Eugen Kogon, *Der SS-Staat. Das System der deutschen Konzentrationslager*, Karl Alber Verlag, Munich 1946, p. 170; we quoted from the English translation: E. Kogon, *The Theory and Practice of Hell*, Secker & Warburg, London 1950, p. 170.

¹²⁰ According to other witnesses, this building already existed in July 1942.

¹²¹ See following section.

¹²² Emmanuel Ringelblum, *Kronika getta warszawskiego*, ed. by Arthur Eisenbach, Cztelnik, Warsaw 1983, p. 416.

“Information from the gravediggers (Jakob Rabinowicz), the Jews from Stoczek, who have escaped from the trains loaded with objects, gold, and cash. Congruent description of the ‘bath,’ the gravediggers with golden patches on the knees.

*Method of killing: gas, steam, electricity.”*¹²³

Until April 1943, the journalist Eugenia Szajn-Lewin lived in the Warsaw Ghetto and kept a diary during this time. She recorded what was said about Treblinka in the ghetto until the end of 1942:¹²⁴

“The worst thing is death in Treblinka. By now, all know of Treblinka. There they cook people alive. They know by now that Bigan has escaped from Treblinka. [...]

He [Bigan] will build halls like the ones in Treblinka. Everything will be modern: the boilers that are heated by current, the steam-gas in there, the floor movable and sloping. ‘There I will drive in the Germans, all naked. Many, many Germans, so that every corner is made use of, every centimeter.’ And from the boilers the gaseous steam is conducted through the pipes, the boilers are red, and the steam... a hellish boiling bath. Four minutes suffice, then the floor flap automatically drops down, and the slimy mass of red, curled bodies flows away into the cesspit. And finished, the pits are simply filled with chlorine, and there is no more trace of what was once alive. ‘All this lasts only seven minutes, you hear me?’”

On November 15, 1942, the resistance movement of the Warsaw Ghetto, operating in the underground, composed a long article entitled “*Likwidacja żydowskiej Warszawy*” (Liquidation of Jewish Warsaw), which contained a detailed description of Treblinka¹²⁵ together with a sketch of the camp.¹²⁶ Due to the importance of this article,¹²⁷ it deserves to be reproduced here in its entirety despite its length. It was sent to the Polish government-in-exile in London on January 6, 1943.¹²⁸ This report was widely disseminated. A complete English translation had already appeared in 1943 in the anthology *The Black Book of Polish Jewry* with the subtitle *Treblinka. Official Report Submitted to the Polish Government*¹²⁹ and reads as follows:

¹²³ Deaths due to electric current were generally imputed at that time to the Bełżec Camp.

¹²⁴ Eugenia Szajn-Lewin, *Aufzeichnungen aus dem Warschauer Ghetto. Juli 1942 bis April 1943*, Reclam Verlag, Leipzig 1994, pp. 83f.

¹²⁵ “*Likwidacja żydowskiej Warszawy*,” in: *Biuletyn Żydowskiego Instytutu Historycznego*, Warsaw, January-June 1951, No. 1, pp. 59-126.

¹²⁶ This sketch is not found in the article listed in the preceding note.

¹²⁷ The author of this chapter pointed out this report in 1985, translating the most essential passages concerning Treblinka. See Carlo Mattogno, *Il rapporto Gerstein, op. cit.* (note 95), pp. 167-170.

¹²⁸ The editors of the *Biuletyn* erroneously give the date of the transmittal of this report to London as November 15, 1942, the day which the text is dated. It was published in Polish by K. Marczevska, W. Ważniewski, *op. cit.* (note 51), pp. 139-145.

¹²⁹ Jacob Apenszlak (ed.), *The Black Book of Polish Jewry*, American Federation for Polish

“The village of Treblinka is situated near the Warsaw-Bialystok railroad line, a few kilometers from Malkinia, in a sandy and wooded area. The population consists of Polish peasant-farmers and forest workers. In 1940, [correct: 1941] the Germans established a penitentiary concentration camp, Treblinka A, on the sandy stretches near the village, for Poles who were guilty of transgressions against the occupant, of not supplying the demanded amounts of agricultural produce, or who were caught smuggling. The discipline at the camp is very strict; prisoners are shot on any pretext. The camp is as notorious as the penitentiary camp at Oswiecim. In March, 1942, the Germans began the construction of another camp, Treblinka B, in the vicinity. That camp has become the slaughter-house for the Jews of Poland and of other European countries. Poles from the nearby Treblinka A, as well as Jews caught in the neighboring villages, were put to work at the preparatory construction. That work lasted until the end of April when the central building of the camp, death-house No. 1, was built. (14).^[130]

Treblinka B is situated on the sandy hills among woodland. The area of the camp is comparatively small, some 5,000 hectares (about 12,500 acres).^[131] It is entirely surrounded by a green fence interwoven with barbed wire entanglements (3). Part of the fence runs through a young forest in the north (25). At the four corners of the camp, observation points were placed for the Lagerschutz (Camp Guard). The Lagerschutz consists mostly of Ukrainians armed with machine-guns. At the observation points strong searchlights have been placed to light the entire place at night. Observation posts are also set in the middle of the camp and on the hills in the woodlands. The western border of Treblinka B is formed by the rail embankment along which runs a side-track that connects the camp with the main railroad-line (1). The side-line (2) was constructed in recent months, in order that the trains of transports might be delivered directly to the slaughter-house. The northern border of the camp is formed in the forest; east and south the border cuts through sandy hills. In the area of the camp, bushes form a long stretch parallel to the railroad tracks starting in the north (25).

A railroad-crossing (4) is adjacent to the side-track; trains with transports halt there.

From that barrier there is an entrance to a square which holds two to three thousand persons. The square is fenced in with barbed-wire. On the square, not far from the northern border, there is a wooden barracks. In

Jews, New York 1943, pp. 141-147.

¹³⁰ The numbers in parentheses, not included in the English translation, are from the Polish original and refer to the sketches appended to the report. See Document 2 in the Appendix.

¹³¹ The size of Treblinka amounted to 13.45 hectares. See the following chapter.

the south-western corner of the square there is a guard-house with a military post on 24-hour duty (7). South of the square, outside of the fence, there is a cloth-sorting place (Lumpensortierungsplatz), and further south, there is the execution place of the camp-commandant and the graves of the victims murdered by him (22). The arrival square (6) is connected with the rest of the area by an entrance in the north-eastern corner of the fence (8). From there, a path runs through the woods for about 200 meters eastwards (9) and then turns at right angles to the south and runs along the forest, parallel to the western limit of the arrival-square. This road stops at a large building of an unusual shape; it is an unfinished one-story brick-construction, about 40 meters long and 15 meters wide. (When we received the information concerning Treblinka B in the first half of September, this building was about to be finished.) The Germans began the construction of that building after the action started, probably in the middle of August, with the help of Jewish artisans picked out from among the Jews brought to Treblinka for slaughter. It is significant that the bricks for the construction had been brought from as far as Warsaw, in trucks attached to each transport. The bricks were loaded in the Warsaw Umschlagplatz by Jewish workers. According to the report of an eyewitness, the interior of the building is as follows; a corridor 3 meters wide runs through the middle; there are five chambers on each side; the height of each chamber is about 2 meters; the area is about 35 square meters. The execution chambers are without windows, but they have doors opening on the corridor and a type of valve on the outside walls. Next to these valves there are large scoops (they remind one of large vessels). In the walls pipes were installed from which water-steam is supposed to pour into the chambers. This was to have been death-house No. 2.

A path (9) skirts the building and runs along its western wall finally ending at the next building (12) near death-house No. 1 (14). This building is at right-angles to the death-house No. 2. It is a brick construction much smaller than the other. It consists of only three chambers and a steam-room. Along the northern wall of this house runs a corridor from which there are doors to the chambers. The outside walls of the chambers have valves (until recently doors which had been changed into valves for utility reasons). Also here a scoop in the shape of a shallow vessel is placed at the height of the valves (15). The steam-room (15a) is adjacent to the building. Inside the steam-room there is a large vat which produces the steam. The hot steam comes in to the chambers through pipes installed there, each having a prescribed number of vents. While this machinery of death is in action, the doors and valves are hermetically closed. The floor in the chambers has a terra-cotta inlay which becomes very slippery when water is poured over it. There is a well next to the steam-room, the only well in the whole area of Treblinka B. Not far from the death-house, south

of the barbed-wire and wooden fences, there is a grave-diggers' camp. The grave-diggers live in barracks (19) next to which are the kitchen buildings. On both sides of the camp there are two guard-houses (17-20). The remaining area of Treblinka B is destined for the murdered victims. A part of that area is already a large cemetery (22, 23, 24). At first, Poles employed in the camps dug the graves; later, as the slaughter was intensified and the need for more ditches grew, special digging-machines (bulldozers) were brought, which ran day and night at grave-digging. A Diesel-motor supplies the energy and its rattle is a characteristic sound at Treblinka B.

The supervisors and execution-staff are small in numbers. The slaughter-house is commanded by an S.S. man of the rank of major (his name is Sauer). The German staff, consisting of S.S. men, are in terror of their chief. The moment they see him from the distance they drive the Jewish workers as well as the victims on their way to death with even greater energy. Altogether, there are ten Germans and thirty Ukrainians.

The German crew changes from time to time; sometimes S.S. men from various towns of the General Government who were active at the deportations there, arrive at the camp.

In addition to the German-Ukrainian Lagerschutz, there is also the Jewish auxiliary, part of whom are busy at the sorting place for the clothing of the victims (Lumpensortierungsplatz), and part of whom act as grave-diggers. They empty the execution chambers and bury the dead; the rest work at the arrival-square. The groups of the Jewish auxiliary service are headed by group-leaders whom the Germans call 'kapos.' They are relatively better fed than the rest and wear a triangular yellow patch at their knees to distinguish them from the others.

The personnel of the Jewish auxiliary service undergoes almost daily changes. Rarely can a Jew stand that service for more than two weeks, due to the inhuman treatment they receive at the hands of the Germans. They are constantly tortured and whipped; corporal punishment (25 strokes) is very frequent as well as the shooting of the weak ones who lose their fitness to work. This is done mostly by the chief himself. Every day there is a roll-call. The German asks who does not feel strong enough to carry on with the work? A few men step out of the row, report their unfitness and beg him – as though for a favor – to be shot. The executions take place at a special spot; the victim himself stands erect over a grave while the chief shoots at the back of the victim's head. The next victim has to step nearer and throw the body of the murdered one into the ditch, and then a few moments later, share the fate of his predecessor. These young Jews are so overworked that all will to resist is gone; on the other hand, the German terror is so atrocious that it makes them even want to die so as not to suffer further inhuman tortures. In one of the first days of September, the chief of Treblinka thus murdered 500 young Jews by shooting them one after an-

other with his gun; what is startling is that not one of this group of a few hundred men attempted to resist death. The execution lasted from 7:30 to 3 p.m.

The relatively lightest work in the death camp is the sorting of the clothing of victims. While assigned that work, one can eat to one's heart's content, for the 'deported' Jews took along large food-stocks: bread, marmalade, fat, sugar. But the chief does not leave the men at this work for any length of time; after a few days, he transfers them to grave-digging.

The gaps in the Jewish auxiliary service are supplemented from among the transports arriving in Treblinka. As a rule, two transports arrive daily: one in the morning and one toward evening. In the period of greatest of the action a few transports arrive daily. Each train consists of a few score of freight cars. Some of the cars halt at the side-track straight across from the arrival-square, while the remaining cars are shifted to the side to wait until the first part is taken care of. The cars are quickly emptied. The tortured and excited throng breathes with relief when let out on the square. They are immediately taken over by the Jewish auxiliary guard headed by the 'kapos.' These give orders in Yiddish. The women and children are ordered to enter the barracks immediately while the men remain in the square. Looking around, they see a high pillar with a poster bearing a large inscription: Achtung Warschauer (Attention, natives of Warsaw) despite the fact that transports of Jews from many other towns of the General Government, from Germany and the states of Western Europe are also brought to Treblinka. 'Do not worry about your fate,' continues the poster. 'You are all going eastward for work; you will work and your wives will take care of your households. Before leaving, however, you have to take a bath and your clothing must be disinfected. You have to deposit your valuables and money with the cashier (of Treblinka) for which you will get receipts. After the bath and disinfection, you will receive everything back unharmed.'

In the first period of murder in Treblinka an S.S. officer with a kind, confidence-inspiring face used to come to the square and hold a speech along the same lines. However, when in the course of action ever larger transports arrived from the various parts and the crowds had to be quickly liquidated, the Germans cancelled the speech as superfluous.

To make the Jews believe that actual classification according to trades would take place at the arrival-square in order to send occupational groups for labor, they placed small signs with the inscriptions: Tailors, Shoemakers, Carpenters, etc. It goes without saying that such segregation never took place.

The 'kapos' quickly put the men in rows of ten, ordering them to take off their shoes, undress completely and prepare for a bath. Everybody is per-

mitted to take along a piece of soap and his documents [sic]. In the meantime the sorting-service men take away the clothing to the sorting-place. Women and children also have to undress completely. Now comes the last act of the Treblinka tragedy. The terrorized mass of men, women and children starts on its last road to death. At the head a group of women and children is driven, beaten by the accompanying Germans, whips in their hands. The group is driven ever quicker; ever heavier blows fall upon the heads of the women who are mad with fear and suffering. The cries and laments of the women together with the shouts and curses of the Germans interrupt the silence of the forest. The people finally realize that they are going to their death. At the entrance of death-house No.1 the chief himself stands, a whip in his hand; beating them in cold blood, he drives the women into the chambers. The floors of the chambers are slippery. The victims slip and fall, and they cannot get up for new numbers of forcibly driven victims fall upon them. The chief throws small children into the chambers over the heads of the women. When the execution chambers are filled the doors are hermetically closed and the slow suffocation of leaving people begins, brought about by the steam issuing from the numerous vents in the pipes. At the beginning, stifled cries penetrate to the outside; gradually they quiet down and 15 minutes later the execution is complete.

Now comes the turn of the grave diggers. Shouting and cursing, the German overseers drive the diggers to their work, which consists of getting the bodies out of the execution chambers. The grave-diggers stand at the scoop, near the valves. The valves open but not a body falls out. Due to the steam all the bodies have become a homogenous mass stuck together with the perspiration of the victims. In their death agonies, arms, legs, trunks are intertwined into a gigantic macabre entanglement. To make it possible for the grave-diggers to get out single bodies, cold water from the near-by well is poured over the mass. Then the bodies separate and may be taken out. As a rule the surfaces of the bodies are not defaced; only the faces and buttocks are purple. The grave-diggers, constantly beaten and driven by the Germans, place the corpses on the scoops until the chambers are empty. The bodies lie piled up like slaughtered cattle. Now the burying takes place. Formerly (during the first half of August), the Jewish grave-diggers had handcarts to convey the bodies to the ditches, which had to be done at top speed. Lately, however, the chief did away with them. 'Ein Mann – zwei Leichen' (one man, two corpses), meaning that each grave-digger has to bury two corpses. He ties the legs or the arms of the body with his belt and running, pulls it from the scoop to the ditches, throws it in and, again running, returns for the next load. Formerly the graves were right at the death-house so that the burying of corpses could take place quickly. As new victims were added, the grave-line moved ever further to the east and the pulling of the corpses to the graves takes longer and longer. After the

ditch is filled, the grave-diggers quickly cover the bodies with earth and the digging-machine nearby prepares the next grave.

The execution of the men is identical. They also are driven through the road in the woods to their death. The victims react differently while being driven in the direction of the death-house; some repeat loudly psalms of penitence, confess their sins; others curse God; but a sudden shout of the Germans and the blows falling upon the backs of the doomed men immediately brings silence on the whole crowd. Sometimes all the victims cannot get into the overcrowded chambers; then the Germans keep the rest in the woods near the slaughter-house. These people see and hear everything but there is no attempt at self-preservation.

This is irrefutable proof of the atrocious terror wielded over their victims by the Germans.

The new death-house provides for the liquidation of 8,000 to 10,000 victims. If we consider that right now 2,000,000 murdered Jews, or the greater part of Polish Jewry, are already buried in the area of Treblinka, the disturbing question arises: for whom do the S.S. intend that new house of death; who are to utter their last breath in the slaughter-house? Most probably the death-machine, once started, will not limit itself to murdering Jews. At present, the specter of death in steam chambers rises before the Polish population; there have already been some signs of it: according to a report of an eyewitness, the Germans exterminated a group of Poles in death-house No. 1, in the second half of August."

On August 8, 1943, The New York Times reported, referring to an article that appeared in a London newspaper: "2,000,000 Murders by Nazis Charged. Polish Paper in London Says Jews Are Exterminated in Treblinka Death House." The subtitle reads: "According to report, steam is used to kill men, women and children at a place in the woods." The article was based upon a contribution published on August 7 in the magazine Polish Labor Fights, which was nothing other than the report of November 15, 1942. This is indubitably clear from the quotes in the NYT article.¹³²

In 1944, Rabbi Silberschein published an eight-page report about the camp "Tremblinki" (a garbling of Treblinka). Although many features suggest that the source for this report is mainly the same as the one of November 15, 1942, it also contains many new elements, especially in relation to the killing technique, which probably stem from a different source. On the grounds of its importance, the document,¹³³ which is as good as unknown to specialists, deserves to be cited *in toto*. On the one hand, Silberschein speaks of "gas chambers" and of "gas, which flows out of pipes," while on the other hand he says

¹³² *The New York Times*, August 8, 1943, p. 11.

¹³³ In his book *Belzec, Treblinka, Sobibor* (note 71), which is accepted as the standard work, Yitzhak Arad does not devote one word to this report.

that the bodies had been clumped together “under the influence of the water vapor.” Thus, either Silberschein (correctly) regarded water vapor as a gas or he was not certain of the killing technique.

The occurrence of many improper linguistic expressions is explained by the fact that it has been translated from the French by a person not fully in command of German. It reads as follows:¹³⁴

“Tremblinka – The Main Extermination Camp

The small village of Tremblinka lies on the Warsaw-Bialostock [sic] rail line. The main extermination camp, three times as large as that of Lublin, was located not far from the village. It was at first set up as a concentration camp for Jews and Poles; but in March 1942, the Germans transformed it into an extermination camp for Jews only. They reconstructed the camp expressly for this and equipped it with gas experimental rooms and ovens.

The Camp

The camp was situated in the midst of dense forests, entirely cut off from the outside world, and was reachable by means of a railway track with the Warsaw-Bialostock main line. It encompassed an area of 100 acres and is surrounded by the thickest barbed wire.

It consisted of three sections: the actual camp; the extermination camp, and an open square. The actual camp has three blocks: a men’s camp, a women’s camp, and between these two a children’s camp.^[135]

A three-meter wide anteroom divides the inside of each block into two parts. From the anteroom doors open into the cells. Each cell measures 36 m² with a height of no more than two meters [...¹³⁶]. Each structure was 40 × 50 m in size. Aside from this, two more elongated buildings, each about 120 × 150 m in size, were constructed later as a men’s camp (not shown in the plan).

The extermination facilities took up approximately the same space as the accommodation spaces and contained a dressing room (see plan). The dressing room contained a reception room for the camp administration, an anteroom, and the actual undressing room. The entrance to the dressing room was from the open square. A door led from the dressing room to the baths, from here a door led to the experimental chamber for gases for suffocation, and from there a door to the ovens. The ovens were connected with a railway, which led to the cemetery (see plan).

A large pedestal had been erected on the open square. There were almost no workshops and only a few job positions in this camp.

¹³⁴ A. Silberschein, *Die Judenauströtung in Polen*, Geneva 1944, third series, pp. 33-20.

¹³⁵ See Document 3 in the Appendix.

¹³⁶ Two illegible words follow.

The Guard Service – The Treatment

An SS detachment under the command of Hauptmann Sauer supplied the guard service in the extermination camp of Tremblinka. The composition of the staff of the detachment changed frequently.

The inmates performed various tasks in connection with the requirements of the camp. They were terribly maltreated and abused at this and had to endure the most inhuman punishments imaginable for every petty violation of the house rules or other mistake. Not all worked, most of them waited in the cells only as long until the gassing facility was able to take them. But sometimes they were killed even sooner in another manner. The Germans shot several Jews on a daily basis, above all the commandant Sauer himself. Every afternoon he had his executioners assemble the Jews who still remained alive. Then he asked: 'Who is weak, who can no longer work?' The Jews made no answer at all to this: whoever had had enough simply stepped forward from the line – and was shot down. In this manner, Hauptmann Sauer had murdered 500 Jewish youths, one after the other, on a single day in the beginning of September 1942.

The 'Kapus'

The 'Kapus' occupied a special position. It was these Jews upon whom many important mechanisms of the camp were imposed. Most Kapus had sorted through the clothing of those who had been transported out of this life. They did this task at a place called the 'rag sorting place.'

Others were also working at the railway station with the reception of those freshly arriving. Others, again, had to work as gravediggers. It happened not rarely that the Jews so occupied lasted no longer than two weeks and committed suicide.

The Delivery

Day after day two trains arrived in Tremblinka, completely filled with Jews. Jews were carried off from all parts of Europe to this place; but the main contingent was made up of the Jews from Warsaw, north Poland, and the Baltic.

Every train was 30 to 50 cars long. The emptying of the cars proceeded at lightning pace. Then the Kapus received the arrivals and read to them the camp regulations in the Jewish language. At the station building, the following appeal was displayed: 'Have no concern about your fate! You are all traveling only to work in the east. You yourselves will perform the work and your women will do the housework. Before traveling on, you have to bathe and remove the germs from your clothes. Gold and other valuables are to be deposited at the counter, where you will get a receipt for them.' And really, in order to lull the belief in these promises into a feeling of se-

curity, the Germans had established an office at the train station, where each new arrival had to turn up and report his professional training. After fulfillment of these 'statistics,' the people were brought into the camp and at first only sent into the disinfection baths. After the bath they were temporarily sent to the individual cells. There they were supposed to wait until it was their turn. But for the most part, those instructed didn't know what fate awaited them. They still believed that they would soon be traveling on to a place of work. This belief was even strengthened by the fact that there were no large factory facilities in the camp and that it had all seemed as if it were only a transit station.

The Murder Work

But when the rooms could no longer accept new arrivals, the oldest inmates were gassed. Every day groups of a thousand people each were brought into the gas and oven chambers. At first, as at their arrival, they were led into the bath by the Kapus. Everyone had to take off clothing and shoes and remained naked. For the further deception of the victims, each was handed a little piece of soap. In the meantime, the work of putting the discarded clothing and shoes in order was performed. Hauptmann Sauer took them over in the reception room of the extermination facilities. He did not miss any opportunity to flog every single person. Then the Germans drove the women and children as the first ones into the extermination cells. Now the final act of the extermination began:

Men and women, old people and children, all naked, take their last walk into death. At the fore stride the women and children, then the men, old and young, follow behind. To impel them to run faster, the Germans strike them on head and body. Now the victims are running, tormented by fear: their cries of dread, especially those of the women and children, ascend to the sky. Now everybody knows where this is leading – to death. The floor is slippery, one slips and falls. But those fallen can no longer even stand up; for continually new victims are flung over them. The children are thrown into the room, above the heads of their mothers. The extermination cells fill up. When they are full, then they are hermetically sealed, from every side the pipes open, out of which flows gas. The death of asphyxiation reaps a quick harvest. Within a quarter hour it is all over. Then the Kapus must go to work. With pitiless blows, the guard personnel force them to perform their work.

The gates of death open – but the dead bodies somehow cannot be pulled out individually: for they have all clumped together with one another and stiffened under the influence of the water vapor.

Water is fetched from a nearby well and the bodies are sprinkled with it so the gravediggers can carry away the corpses. These are loosened by it, one

from the other, and it is easier to remove them. Their appearance has not changed, aside from a violet coloration of the head and the back side [sic]. Now the dead are loaded onto the ramp, conducted over a railway to the cemetery in the mass graves, where the Kapus bring their task to an end. (See the almost identical description in the article by Tymon Terlecki 'Alle Juden raus,' cited by us on page 18 in 'L'extermination des Juifs polonais IV').^[137]

By many hundred thousands, Jews from all regions of Europe have been exterminated in this way in Tremblinka alone.

The Camp Orchestra

But the camp of Tremblinka had another 'specialty.' To wit, the Jewish Arthur Gold Orchestra (see plan) gave concerts there, and it had the duty of playing for those who were being led to their death!!!! At the same moment as thousands of Jews were perishing in the gas chambers, the musicians had to play cheerful melodies. Whichever of them refused to do it was hanged up by his feet with his head down. Several of the musicians were seized by madness in the middle of playing. The artists, one after the other, jumped willy-nilly amongst the crowd of people who were waiting for their turn, and they bellowed with voice breaking and face madly distorted 'Frait och, yidelach, ir got zum tot mit klezemer!' (Enjoy yourselves, you Jews, you are going to death with music). Then the German bullets whizzed, and they sank under them to become a lifeless lump on the ground. After this the orchestra was brought up to strength again and the performance was repeated every time."

In a report dealing with alleged German crimes in Poland, authored by the Polish government for the Nuremberg Court and presented by the Soviets as Document USSR-93, the following is written regarding Treblinka:¹³⁸

"When the process of exterminating Jews was initiated, Treblinka became one of the first camps to which victims were brought. They were put to death in gas chambers, by steam and electric current" (Emphasis added.)

Charge No. 6 of the Polish government against Hans Frank, according to which "The German authorities acting under the authority of Governor General Dr. Hans Frank established in March 1942 [sic!] the extermination-camp at Treblinka, intended for mass killing of Jews by suffocating them in steam-

¹³⁷ This article appeared on November 7, 1943, in No. 45 of the political newspaper *Wiadomosci Polskie*, published in London, in which Tymon Terlecki quoted longer sections from the already cited report of November 15, 1942.

¹³⁸ USSR-93, English version. The Republic of Poland in the case against: 1. German war criminals. 2. Their corporate bodies and organizations, designated under Charge No. 1 before the International War Court, p. 44. An indication as to the report's credibility is given by the inclusion of a chapter entitled "A Soap Factory of Human Fat" following the section on Treblinka!

filled chambers,” is based in essence on the report of November 15, 1942, from which large excerpts were cited. In these the description of the structure of the two “death-houses” as well as the alleged system of killing is given particular attention.¹³⁹

As late as 1961, a witness in Düsseldorf testified in a deposition – presumably in the preliminary stage of the trial against the (alleged) last Treblinka Commandant Kurt Franz¹⁴⁰ – that the victims had been killed with steam in Treblinka.¹⁴¹

3. Significance of the Report of November 15, 1942, for Historiography

The report of November 15, 1942, is the most important historical source for the Treblinka Camp during the time of its existence, and the entire subsequent official historiography relies on this report, beginning with the description of the alleged ‘gas chambers.’ Nevertheless, it has been such a headache for the official historians that they occasionally cite it with blatant falsification.

The Israeli historian Yitzhak Arad summarizes it as follows:¹⁴²

“In this document there is a description of the construction of the Treblinka extermination camp, its location, its size, and a detailed plan, including a sketch of the area. This report also includes a description of the dozens [sic] of new gas chambers and other structures in the camp. With regard to the camp staff, it states that, in addition to the Germans and Ukrainians there are also Jews, whom the document calls ‘Jewish auxiliaries’, who are employed at ancillary works, in sorting of clothes of the murdered and removing the corpses from the gas chambers and burying them. The document mentions the extremely difficult conditions under which the prisoners are kept, the daily killings among these Jews, and that their life expectancy in this camp was no more than two weeks. In the description of the way the transports were treated, there is reference to the deceptive ploys of the Germans and a description of the extermination process from the moment the people disembarked on the platform – the way they were tortured – until they were led into the gas chambers, as well as the system of burying the corpses. In conclusion, it stated that by then two million Jews had been murdered in Treblinka – the majority of Polish Jewry. The report con-

¹³⁹ PS-3311, *IMT*, Vol. XXXII, pp. 154-158. On December 5, 1945, the document was sanctioned by its author, Dr. Tadeusz Cyprian, the Polish deputy representative at the War Crime Commission of the United Nations in London, through his signature.

¹⁴⁰ See Chapter V.

¹⁴¹ K. Marczevska, W. Waźniewski, *op. cit.* (note 51), p. 134.

¹⁴² Yitzhak Arad, *op. cit.* (note 71), pp. 354f.

cludes by asking why the new gas chambers were built, since indeed the majority of Polish Jewry had already been killed, and states that, according to one eyewitness, the Germans had already killed a group of Poles in the middle of August.

This report is the first in which there is a comprehensive description of the Treblinka extermination camp. The facts are, for the most part, correct. Their source is escapees from the camp who reached the Warsaw ghetto and who gave testimony for the Ringelblum Archive and to Jewish underground groups in the Warsaw ghetto. This report is based therefore on the descriptions of witnesses who had seen for themselves the process of extermination, who had lived in the camp for days or weeks as prisoners, who had been employed at various jobs, and who had succeeded in escaping. The facts that they related on the basis of what they had seen were accurate, but the reference to two million Jews murdered was incorrect. In the period to which this report refers, one-fourth to one-third of the number cited in the report had been murdered. Also the detail about the murder of a group of Poles in Treblinka was incorrect."

The coarse falsifications, of which Arad, regarded by the official historiography as the most renowned Treblinka expert, is guilty here, make one imagine his mortal embarrassment in the face of this historical source of such unusual importance. The source, however, contradicts one of the main pillars of precisely this official historiography by the fact that it mentions, not diesel gas chambers, but instead water vapor chambers as the murder weapon.

Arad claims, however, that the report contains "a description of the dozens of new gas chambers" as well as a description of the "process of extermination," but he doesn't write a single syllable about the steam chambers: instead he shamelessly transforms them into "gas chambers"! Furthermore, he asserts that the facts are "for the most part, correct" and that the witness testimony was "accurate," although the official historiography had long since banished the steam chambers to the realm of myths.

The Polish historian Józef Marszałek furnishes a summary no less dishonest when he writes:¹⁴³

"In this section [of the report] the site and topography of the camp are shown exactly, and the number of the gas chambers^[144] as well as their

¹⁴³ Józef Marszałek, "Rozpoznanie obozów Śmierci w Bełczu, Sobiborze, e Treblince przez wywiad Armii Krajowej i Delegatury Rządu Rzeczypospolitej Polskiej na Ktaju" (The Reconnaissance of the Death Camps Bełzec, Sobibór, and Treblinka by the Intelligence Service of the Homeland Army and the Delegation of the Government of the Republic of Poland in the Homeland), in: *Biuletyn Głównej Komisji Badania Zbrodni przeciwko narodowi polskiemu / Instytutu Pamięci Narodowe*, Vol. XXXV, Warsaw 1993, p. 42.

¹⁴⁴ "komór gazowych"

structure with the facilities for the gassing^[145] of the victims are described.”

We now turn to the question of how the miraculous transformation of the steam chambers into gas chambers occurred.

4. From Steam Chambers to Carbon Monoxide Chambers

In August 1944, the Soviets occupied the area around Treblinka and conducted a military forensic investigation with examination of the camp grounds as well as witness interviews.¹⁴⁶ The murder method most frequently mentioned by the witnesses differed from those already mentioned and consisted of the evacuation of air from hermetically sealed rooms by means of a vacuum pump driven by an engine. This engine, which at first was merely said to have been used to run the pump, was to gradually transmogrify into a murder weapon – at first, in connection with the evacuation of air, then becoming, thanks above all to Jankiel Wiernik, the only murder instrument, by which the victims were killed with carbon monoxide gas.

The murder technique of suffocation by pumping out air was described by two witnesses in particular. Abe Kon, a former Treblinka prisoner, stated on August 17, 1944:¹⁴⁷

“I was sent into the Treblinka Camp in October 1942 with my relatives – father, mother, two sisters, a brother. [...] The naked people walking by were struck by whips. They were walking to a building, which had been nicely built with cement. A Jewish symbol, the ‘Star of David,’ was attached to the house. At the entrance to the ‘bath’ stood a Ukrainian with a knife and whip. He stabbed those who did not want to enter with the knife and dragged them into the building. The service staff named this Ukrainian ‘Ivan the Terrible.’

Plan of the ‘Bath’: the bath consisted of 12 cabins. Each cabin measured 6 × 6 m. The height amounted to 2.5 m. They drove 600 people in each cabin. They threw the children on their heads. The cabins had two doors, which could be sealed hermetically. In the corner between ceiling and wall two openings were connected with hoses. Behind the ‘bath’ stood a machine. It pumped the air out of the chambers. The people suffocated within 6 to 15 minutes. The second door was opened and the people were dragged out. Their teeth were examined and golden teeth were ripped out. From there the bodies were carried away on stretchers and were buried in the

¹⁴⁵ “do gazowania”

¹⁴⁶ See following chapter.

¹⁴⁷ GARF, 7021-115-11, pp. 33f.

ground. They weren't buried any farther than 100 m away from the 'bath.' People were driven into the 'bath' three times a day. In this way 15,000 to 18,000 persons were destroyed each day. That's how it went for two months. Later, machines dug these bodies up and they were cremated in ovens. There were no fewer than one million burned.

Later, the extermination process proceeded as follows: suffocation and burning. They were incinerated in a specially manufactured oven, which could hold up to 6,000 bodies. The oven was filled with corpses. Gasoline or petroleum was poured over them and burned. The cremation lasted up to an hour. [...] Those who could not walk to the 'bath' – invalids, old people – were sent to the 'hospital'; they went there. They were placed at the edge of a deep pit on the bottom of which was a pyre made up of human beings. The victims were shot in the back of the neck, whereupon they fell into the pit and burned. So it went, day after day."

On August 22, 1944, the Pole Kazmierz Skarzyński gave the following statement:¹⁴⁸

"Incarcerated Jews in the camp reported that many hundreds of prisoners at a time were penned in hermetically sealed chambers and were asphyxiated by pumping out the air. The people died very quickly – in 10 or 12 minutes. According to the stories of the Jews, the oven [sic] was a pit of 25 m in length, 20 m wide and 5-6 m deep, with a grate made out of train rails on the bottom of the pit, which served as an air vent. The bodies were piled on the rails and burned. The glow from the fire was visible at a distance of 15 km. During the day a black smoke spread. In a strong wind, the smell of burning was still perceptible 30 km from the camp."

The air evacuation technique of killing also turns up in the first official Soviet report concerning Treblinka I and II. It originates from August 24, 1944. Regarding Treblinka it reports:¹⁴⁹

"The 'bath' was a house that consisted of 12 cabins each 6 × 6 m in size. They drove 400 to 500 people into one cabin at the same time. They had two doors, which could be hermetically sealed. In the corner, between ceiling and wall, there were two openings connected with hoses. Behind the 'bath' stood a machine. It pumped the air out of the room. The people suffocated in 6 to 10 minutes. The second door was opened and the dead were brought in wheel barrows to the special ovens."

On September 15, 1944, a Polish-Soviet commission issued a "protocol of a provisional preliminary investigation and inquiry into the former concentration camp Tremblinka" [sic], where we read:¹⁵⁰

¹⁴⁸ GARF, 7021-115-11, p. 16.

¹⁴⁹ GARF, 7021-115-9, p. 108.

¹⁵⁰ GARF, 7021-115-11, p. 44.

“In the beginning, the method employed was to pump the air out of the room by means of a small car engine. Then, as a result of the large number of the doomed, a chemical substance began to be used.”

Vassili Grossmann entered Treblinka in September and spoke with the witnesses, who were also questioned by the Soviet investigative commission at that time. As he relates in his book, he reconstructed the picture of Treblinka “according to the stories of living witnesses,” the “statements of people who worked in Treblinka from the first day of the establishment of the camp until August 2, 1943.”¹⁵¹ Grossmann, however, declared that he was not satisfied with repeating the contradictory statements of these witnesses, but in attempting to connect them into a coherent historical portrayal:¹⁵²

“In the beginning, even the pressure and suction devices functioned poorly; at that time, the suffering of the unfortunates dragged on for eight to ten hours. The most diverse means were employed for killing: the exhaust gases of a heavy armored tank engine, which served the power station of Treblinka, were forced in. [...]

The second most commonly used procedure in Treblinka was to pump the air out of the chambers with the help of special suction equipment – the causes of death were approximately similar to those in the poisoning with carbon monoxide gas: the oxygen supply for the people was blocked. And, finally, the third method, rarer but likewise employed, the murdering by steam, which was also based on denying oxygen to the organism: the steam forced the air out of the room. Various toxic gases were also used, but merely for experimental purposes; the factory-scale mass murder was carried out in the manner described in the first two procedures mentioned.”

At the end of 1945, on the occasion of their questioning by the Polish examining judge Z. Łukaszkiewicz, the Treblinka witnesses were still uncertain about which of the various extermination techniques they should give preference to. In a statement given between October and December, witness Szymon Goldberg described the following method of killing in the “gassing cabins” of Treblinka:¹⁵³

“The Jews were poisoned in that the air was pumped out – there was a machine for pumping out the air – and gas [i.e., exhaust fumes] of a vehicle were introduced. Ether was burned and this vapor introduced inside. Then there was also chlorine.”

On October 12, 1945, witness Henryk Reichmann put on the record:⁴¹

“The killings were carried out either by pumping out of the air or by introduction of CO. Once, when fewer transports were arriving, the Germans

¹⁵¹ Wassili Grossmann, *Die Hölle von Treblinka*, in: *Die Vernichtungslager Maidanek und Treblinka*, *op. cit.* (note 26), p. 33.

¹⁵² *Ibid.*, p. 49f.

¹⁵³ Wydawnictwo Centralnej Żydowskiej Komisji Historycznej (ed.), *Dokumenty i Materiały*, *op. cit.* (note 39), p. 179.

conducted an experiment: They pumped out the air without introducing poison. When the doors were opened after 48 hours, we found some living people inside."

The statement of the witness Stanisław Kon of October 7, 1945, was similar in content:¹⁵⁴

"The killing took place by means of pumping out the air or by the introduction of engine exhaust gases."

In January 1946, Rachel Auerbach, a member of the Jewish Central Historical Commission, published her aforementioned book, which was later issued in English under the title *In the Fields of Treblinka* in 1979 by Alexander Donat. There, the way the gas chambers worked is described as follows:¹⁵⁵

"The motor, installed in a workshop near the bathhouse, could be started now. First, a suction pump was brought into play to draw the pure air from the chamber. After that, the pipe to the reservoir of exhaust gas from the motor could be opened.

[...] At the last moment, it seems, when the pump started to suck out breathable air, all self-control broke and there was an outbreak of collective hysteria inside the gas chamber."

A succinct example of the hopeless confusion, which then prevailed among the eyewitnesses as to the method employed in Treblinka for the extermination of Jews, is the testimony of Samuel Rajzman. Rajzman, characterized by A. Donat the "Nestor of the Treblinka survivors,"¹⁵⁶ was questioned on September 26, 1944, by the military examining judge of the military prosecutor's office of the 65th Soviet Army, First Lieutenant of Justice Jurowski. He stated that he had arrived in Treblinka on September 27, 1942, and remained there until August 2, 1943. Therefore, according to his statement, he spent more than ten months in the camp and must have known all about the gas chambers and their function, if there were any. Yet he reported the following:¹⁵⁷

"Dr. Horonschitzki likewise had no admittance into the cabins, but of what was known to him, he told me the following: the people were driven in large parties into the cabins of the so-called 'baths.' These cabins were hermetically sealed. In the first period, the killing occurred by means of pumping out the air from the cabins; then one resorted to other methods – poisoning by chlorine gas and Cylon-gas. On the camp territory there was a special store of materials with a large amount (up to 15 tons) of so-called Chloren. Chloren came in blocks, white in color. I saw barrels of this Chloren were carried into the second division every day. I did not see containers with of, but rarely and periodically various crates arrived with

¹⁵⁴ Z. Łukaszewicz, *op. cit.* (note 32), p. 47.

¹⁵⁵ A. Donat, *op. cit.* (note 4), pp. 35f.

¹⁵⁶ *Ibid.*, "Acknowledgements," p. 5.

¹⁵⁷ USSR-337, p. 9 of the German version.

the transports, which were taken over by the guard staff of the 2nd division without delay. The engines in the 'bath rooms' ran 24 hours without interruption. Whether poisoning by means of gas mist occurred, I have not heard."

A month earlier, in August, Rajzman had written a 16-page report entitled *Kombinat Smerti v Treblinke* (death factory in Treblinka),¹⁵⁸ in which he depicts the method of extermination in Treblinka as follows:¹⁵⁹

"After being sheared, the women were sent into the 'bathing establishment,' which consisted of a row of chambers, each of which could hold 700 persons. In the chambers towels were hanging, and there was a sign posted with the inscription 'Rules for using the bath'! The people were led in, and the doors were hermetically sealed. In the beginning, the method of pumping out the air was employed: the people died the death of asphyxiation under frightful torments. As time went by, the Germans switched to poisoning with gas, which went more rapidly. Each group stayed in the chamber from 12 to 20 minutes, no longer, for masses of new arrivals were waiting for their turn in the 'bath.' After twenty minutes, the bodies were already afire on an enormous pyre. Sometimes desperate lamentation sounded from the fire. The Germans paid no attention to it – an expression of the 'extraordinary German tenderheartedness.' There were instances when one of the Germans delivered the coup de grâce to one of those thrown alive into the fire. Before the bodies fell into the fire, they were examined by a group of 'dentists', who checked whether perhaps there were teeth, crowns, or fillings of gold present; all of it was torn from the mouths of the dead by pliers.

The corpses were burned in a huge construction pit. Cement foundations were erected on its bottom, upon which grills made from railway rails were fixed. Under the grills burned a strong fire, into which some kind of fluid was poured. The workers at the ovens [sic] were changed every few days, and only rarely did one remain more than a week long at this 'work.' They were replaced by a fresh labor force, which came in with the new trains day after day. In 'reward' for their days of labor, these prisoners were not sent into the 'bath,' but were killed instead by a shot to the back of the neck."

At the Nuremberg Trial, where he took the witness stand on February 27, 1946, Rajzman merely spoke of the "gas chambers," without going into any closer detail about their structure or the type of gas used.¹⁶⁰

¹⁵⁸ This notice is mentioned in the report, which was written on August 24, 1944, by representatives of the 65th Soviet Army. It was adopted by the Soviets as a piece of evidence for their documentation.

¹⁵⁹ S. Rajzman, *Kombinat Smerti v Treblinke*, GARF, 7021-115-8, pp. 7f.

¹⁶⁰ *IMT*, Vol. VIII, pp. 324-329.

In the same year 1946, Rajzman composed an eight-page report with the title *Mój pobyt w Treblince* (My Stay in Treblinka).¹⁶¹ Here, he claimed that 25,000 people per day had been murdered in Treblinka,¹⁶² but did not elaborate on the means of killing.

By the 1950s, Rajzman had happily associated himself with the official version of the ‘gas chambers,’ but he remained perfectly silent about the details. In his report, published in English by Donat, he contents himself with the following remarks:¹⁶³

“The women had to line up, and all their hair was clipped off. It was destined for use in German mattresses. Naked, they went the road of no return, into the gas chambers. While they undressed and walked into the gas chambers, the Germans hit them very hard; many died from the beatings alone. Everybody was pushing to get to the gas chamber fast, because the Ukrainians and the Germans were beating them so hard. Everybody was stampeding forward. The whole place was covered with blood. People didn’t know that it would be the end there; the idea was simply to get out of the place where they were beating you. And in doing that, they went straight into the gas chambers.”

In these few sentences, Rajzman thus mentions the ‘gas chambers’ four times, but spares not a word as to their structure and manner of functioning.

5. Origin of the Carbon Monoxide Version

Let us summarize: at the end of 1945, three different methods of mass murder were still contending for first place: steam, evacuation of air, and engine exhaust. As mentioned, the Polish government gave preference to steam at the Nuremberg Trial and thereby conferred upon this method the official consecration of ‘historical fact.’

In what came next, this ‘historical fact’ was declared a myth, and the steam had to give way to the exhaust gases of a diesel engine.

What was the origin of this version? And why did the latter ultimately prevail?

The claim that in Treblinka murder was committed by engine exhaust was surfacing (with no indication of the type of engine) here and there as early as 1942, but soon vanished into oblivion again. It was picked up anew and enlarged on by Jankiel Wiernik. By his own testimony, Wiernik was deported to

¹⁶¹ Wydawnictwo Centralnej Żydowskiej Komisji Historycznej (ed.), *Dokumenty i Materiały*, *op. cit.* (note 39), pp. 182-190.

¹⁶² *Ibid.*, p. 186.

¹⁶³ A. Donat, *op. cit.* (note 4), p. 232. Donat states that this text is based upon an English translation, by one Howard Roiter, of an eyewitness report given by Rajzman in the Yiddish language and recorded on tape (p. 251).

Treblinka on August 23, 1942, and remained there until August 2, 1943, the day of the prisoner uprising. In May 1944 he published a report about Treblinka in the Polish language, which was published in English translation in the United States that same year.¹⁶⁴ Wiernik has the following to report about the first gassing facilities:¹⁶⁵

“When I arrived at the camp, three gas chambers were already in operation; another ten were added while I was there. A gas chamber measured 5 × 5 meters and was about 1.90 meters high. The outlet on the roof had a hermetic cap. The chamber was equipped with a gas pipe inlet and a baked tile floor slanting towards the platform. The brick building which housed the gas chambers was separated from Camp No. 1 by a wooden wall. This wood wall and the brick wall of the building together formed a corridor, which was 80 centimeters taller than the building. The chambers were connected with the corridor by a hermetically fitted iron door leading into each of the chambers. On the side of Camp No. 2 the chambers were connected by a platform four meters wide, which ran alongside all three chambers. The platform was about 80 centimeters above ground level. There was also a hermetically fitted wooden door on this side.

Each chamber had a door facing Camp No. 2 (1.80 by 2.50 meters), which could be opened only from the outside by lifting it with iron supports and was closed by iron hooks set into the sash frames, and by wooden bolts. The victims were led into the chambers through the doors leading from the corridor, while the remains of the gassed victims were dragged out through the doors facing Camp No. 2. The power plant operated alongside these chambers, supplying Camps 1 and 2 with electric current. A motor taken from a dismantled Soviet tank stood in the power plant. This motor was used to pump the gas into the chambers by connecting the motor with the inflow pipes. The speed with which death overcame the helpless victims depended on the quantity of combustion gas admitted into the chamber at one time. [...]

Between 450 and 500 persons were crowded into a chamber measuring 25 square meters. [¹⁶⁶...] The chamber was filled, the motor turned on and connected with the inflow pipes, and, within 25 minutes at the most, all lay stretched out dead or, to be more accurate, were standing up dead.”

There is no mention in any other witness testimony of the two additional gas chambers, and official historiography knows nothing of them either.

¹⁶⁴ R. Czarkowski, *Cieniom Treblinki*, *op. cit.* (note 75), p. 30; Yankel (sic) Wiernik, *A Year in Treblinka*, published by American Representation of the General Jewish Workers' Union of Poland, New York 1944. The text can also be found in A. Donat, *op. cit.* (note 4).

¹⁶⁵ A. Donat, *op. cit.* (note 4), p. 157-159.

¹⁶⁶ That would be 18 to 20 victims per square meter!

A few pages later, Wiernik gets into the details of the new gassing facilities:¹⁶⁷

“The new construction job between Camp No. 1 and Camp No. 2, on which I had been working, was completed in a very short time. It turned out that we were building ten additional gas chambers, more spacious than the old ones, 7 by 7 meters or about 50 square meters.¹⁶⁸ As many as 1,000 to 1,200 persons could be crowded into one gas chamber. The building was laid out according to the corridor system, with five chambers on each side of the corridor. Each chamber had two doors, one door leading into the corridor through which the victims were admitted; the other door, facing the camp, was used for the removal of the corpses. The construction of both doors was the same as that of the doors in the old chambers. The building, when viewed from Camp No. 1, showed five wide concrete steps with bowls of flowers on either side. Next came a long corridor. There was a Star of David on top of the roof facing the camp, so that the building looked like an old-fashioned synagogue. [...]

The motor that generated the gas in the new chambers was defective, and so the helpless victims had to suffer for hours on end before they died. [...] When the chambers were opened again, many of the victims were only half dead and had to be finished off with rifle butts, bullets or powerful kicks.”

Two important elements make it possible for us to penetrate to the origin of this version of the extermination method in Treblinka: the camp plan published by Wiernik and his reference to the “power plant” which “operated alongside these chambers” and supplied “Camps 1 and 2 with electric current.”

Document 4 in the Appendix shows the plan of Treblinka, which Wiernik has published in order to lend credibility to his claims. In reality, he quite simply copied the plan enclosed with the report about the steam chambers dating from November 15, 1942 (see Document 2 in the Appendix). Both plans bear the same designation: “*Treblinka. Szkic orientacyjny*” (Treblinka, orientation sketch);¹⁶⁹ both depict the same map legends;¹⁷⁰ and, on both, the facilities are numbered 1 through 26, which is explained in the report of November 15, 1942, but not in Wiernik’s exposition. The first three “extermination chambers,” called “steam chambers” in the report of November 15, 1942, but “gas chambers” in Wiernik’s report, are designated by the number 14 in both plans. Similarly, a boiler room for the production of steam is represented by number 15a in the November 15, 1942, report, while on Wiernik’s plan it is a gassing engine. In addition, the description of the two gassing installations –

¹⁶⁷ A. Donat, *op. cit.* (note 4), pp. 161f., 164.

¹⁶⁸ In this case, 20 to 24 persons would have stood on one square meter!

¹⁶⁹ On both plans the word Treblinka is underlined by a broken line.

¹⁷⁰ In the map legend of Wiernik, under Point 3 is printed, instead of “parkan” (fence) the synonym “plot.”

the first with three and the second with ten chambers – fully and completely corresponds to the report of November 15, 1942, and to the camp plan which was enclosed with it!

Precisely for the reason that it is the product of plagiarism, Wiernik's sketch has a paucity of features of this kind: not only are many buildings of the camp missing, but also the cremation grills, although he wrote his report in the year 1944. Wiernik only 'rectified' his error in 1945 by furnishing a new, 'corrected' plan of Treblinka. If one compares this with that of the year before, the plagiarism shows up even more glaringly.¹⁷¹

During Session 66 of the Jerusalem Eichmann Trial, Wiernik produced the 1945 plan, which entered the records as Document T-1300, yet mendaciously claimed to have drawn it in the year 1943.¹⁷²

Thus it is clear that Wiernik simply plagiarized the plan from the report of November 15, 1942, and in so doing replaced the word "steam chambers" with "gas chambers". Why did he do this? Presumably he was of the opinion – to be sure with good reason – that the versions of mass murders in Treblinka then current were too simpleminded. On the other hand, the idea of the engine all but clamored for acceptance.

That there was an electrical power supply in Treblinka is not only probable, it is certain. Every concentration camp had such facilities. Even camps connected to the local electrical supply were equipped with an emergency power supply. This was all the more true of those which – like Treblinka – were not connected to the local electric supply. In Treblinka, the electric power supply was no emergency device, but rather the camp's own plant for supplying it with the electricity necessary for its functioning; consequently it had to be in operation 24 hours a day. The generator of such a power supply was usually driven by a diesel engine. In view of the importance of this engine, a special engine – naturally new – was normally employed. How technologically complex such an installation was regarded emerges from, for example, the "*Kostenvoranschlag über Notstromanlage*" (cost estimate for back-up power plant) which was prepared for the concentration camp Auschwitz on November 10, 1940, by the firm of Georg Grabarz, Master Electrician, from Gleiwitz.¹⁷³ We shall return to this later.

Where was the power plant located in Treblinka? As we have seen, Wiernik claimed that it had been installed by the first "gassing house." This is also claimed by Rajzman, who reports:

¹⁷¹ See Document 5 in the Appendix. The plan was published by Filip Friedman in his book *To jest Oświęcim! (This Is Auschwitz!)*, Krakow 1945. An English translation followed in the year 1946, under the title *This Was Oświęcim!*, the United Jewish Relief Appeal, London 1946. The plan appears there on pp. 82f.

¹⁷² State of Israel. Ministry of Justice, *The Trial of Adolf Eichmann. Record of Proceedings in the District Court of Jerusalem*, Jerusalem 1993. Vol. III, pp. 1201-1203.

¹⁷³ RGVA, 502-1-128, pp. 45-49, see Document 21 in the Appendix.

“The engines in the ‘bath rooms’ ran 24 hours without interruption.”

By the “bath rooms” the supposed homicidal chambers are meant. That one or more engines are supposed to have been in operation “24 hours without interruption” cannot be explained on the basis of the requirements for an extermination program, in which such engines would have run only a few hours a day, but solely by the necessity of producing electricity for the camp around the clock.

That the story of the engine exhaust gas chambers lacks any kind of basis in reality and is nothing else but a propaganda fairy tale is shown beyond doubt by Wiernik’s description of the corpses of the alleged gassing victims:¹⁷⁴

“All were equal. There was no longer any beauty or ugliness, for they all were yellow from the gas.”

Relying upon the statements of three eyewitnesses, Rachel Auerbach writes:¹⁷⁵

“The bodies were naked; some of them were white, others were blue and bloated.”

As a matter of fact, the victims of carbon monoxide poisoning exhibit a cherry-red or rosy red coloring.¹⁷⁶ This is caused by carboxy hemoglobin, which forms as a reaction of carbon monoxide with hemoglobin in the blood.

What happened next is extremely odd:

The Polish government was acquainted with Wiernik’s writing and even mentioned it in its official report, submitted to the Nuremberg Tribunal, concerning the alleged German crimes in Poland, which was presented by the Soviets as Document USSR-93. It states:¹⁷⁷

*“As in other cases, so also in this one, a document is produced first-hand, which describes the conditions and crimes in Treblinka. It originates from one who had been a prisoner, who succeeded in escaping from the camp. This was Yankiel Wieszniak [sic], a Jewish master builder, who spent a year in Treblinka. He produced a report about Treblinka which, as he suggests in his preface, comprises the sole meaning of his continuing to live on.”*¹⁷⁸

In this report, however, the Polish government does not mention the killing method described by Wiernik – engine exhaust gases – with a single word, but speaks merely of steam and electricity. This means, of course, that they did not credit the gassings, but all the same did not want to dispense with a ‘first-class’ prosecution witness. Thus this strange compromise.

At the Nuremberg Trial, Chief Counsel L.N. Smirnov, assistant prosecutor for the Soviet Union, took up this point of the Polish report at the presentation of document USSR-93 (and garbled Wiernik’s name even more badly):

¹⁷⁴ A. Donat, *op. cit.* (note 4), p. 159.

¹⁷⁵ *Ibid.* (note 4), p. 36.

¹⁷⁶ Friedrich P. Berg, *op. cit.* (note 98), p. 439 as well as his footnote 22.

¹⁷⁷ USSR-93, p. 45 of the German version.

¹⁷⁸ Two citations follow from Wiernik’s introduction to his book, *op. cit.* (note 164).

“On page 70 of the Russian text of this report, you find a passage from the statement of a carpenter from Warsaw, Jakob Vernik [sic], a carpenter from Warsaw, who spent a year in the extermination camp of Treblinka 2. [...] This is what Vernik said in presenting a report on Treblinka to the Polish Government; a report which, as he stressed in his foreword, was his only reason ‘to continue his pitiful life.’”

But in reality, no ‘report’ follows in the Soviet folder of documents, merely the two citations from Wiernik’s report which appeared in the Polish document and which had been copied by Smirnov.¹⁷⁹

6. Triumph of the Carbon Monoxide Version

Finally, the following question needs to be addressed: why and when did the carbon monoxide gas chambers prevail over the steam chambers? The reason for this was twofold and cogent. First of all, not even those of mediocre education could take seriously the fable of extermination by steam. The British-Jewish historian Gerald Reitlinger rightly comments:¹⁸⁰

“It is difficult to see how people could be exterminated by steam, [...]”

In fact, any kind of sauna would then be a ‘steam extermination chamber’! This was doubtlessly the reason Examining Judge Z. Łukaszewicz, in his report about Treblinka of December 29, 1945, jettisoned the most foolish of the diverse murder methods claimed by the witnesses and retained only those, which seemed most credible to him: namely, the engine exhaust gases.¹⁸¹ Yet at first his report found little resonance.

On the other hand, the so-called ‘Gerstein Report’ attracted the interest of historians directly after its publication and became at once the ‘proof’ *par excellence* for the existence of the alleged ‘extermination camp’ Bełżec (as well as, secondarily, of the ‘extermination camp’ Treblinka). The Gerstein Report proved to be decisive for historiography regarding the choice of the murder weapon – diesel exhaust gases – for the three alleged ‘extermination camps’ of Bełżec, Treblinka, and Sobibór.

Thus, the report of the Polish government was seen as totally unworthy of belief, for this mentioned a killing method for Bełżec, which was scarcely less absurd than the ‘steam chambers’ of Treblinka: electric current:¹⁸²

“Under the pretext that they were being led into the bath, the Jews were completely undressed and herded into the building. Through the floor of

¹⁷⁹ IMT, Vol. VIII, pp. 239f.

¹⁸⁰ Gerald Reitlinger, *The Final Solution. Hitler’s Attempt to Exterminate the Jews of Europe 1939-1945*, J. Aronson, Northvale, N.J., 1987, p. 149, footnote.

¹⁸¹ USSR-344, p. 321 (p. 5 of the report).

¹⁸² USSR-93, pp. 41f. of the German version.

this building flowed a strong electric current; thousands of human beings were killed here.”

In the session of February 19, 1946, Smirnov recited the following passage from the report of the Polish government (Document USSR-93):¹⁸³

“[...] in the last paragraph on Page 136 of the document book, we may read that Camp Belsen^[184] was founded in 1940; but it was in 1942 that the special electrical appliances were built in for mass extermination of people. Under the pretext that the people were being led to the bath-house, the doomed were undressed and then driven to the building where the floor was electrified in a special way; there they were killed.”

In its official report, the Polish government also dealt with the Sobibór Camp, but only in passing in just nine lines; the Jews, it reads there, had been killed in Sobibór in “gas chambers,” but no particulars were given.¹⁸⁵

In December 1947, Elias Rosenberg, who later called himself Eli(y)ahu Rosenberg, wrote a report about Treblinka, which was obviously influenced by the ‘Gerstein Report,’ in which the version of the killing by “exhaust fumes of a single diesel engine” now felicitously appeared. Yet this text yellowed for decades in an archive¹⁸⁶ and emerged into the spotlight only during the Demjanjuk Trial.¹⁸⁷

In 1951, Léon Poliakov used the ‘Gerstein Report’¹⁸⁸ in order to give substance to the rumor of the ‘extermination camps’ in Poland. He quoted a long excerpt from it and concluded as follows:¹⁸⁹

“There is little to add to this description, which holds good for Treblinka and Sobibor as well as for the Belzec camp. The latter installations were constructed in almost the very same way, and also used the exhaust carbon monoxide gases from Diesel motors as the death agent.”

¹⁸³ *IMT*, Vol. VII, pp. 576f.

¹⁸⁴ Transcription error of the Russian name “Белжец” (so in the original Russian document) for Belżec, transcribed for its part from the Polish. In the German version of the protocol, the spelling is “Beldjitze”, *IMG*, Vol. VII, p. 633f.

¹⁸⁵ USSR-93, p. 42. At the Nuremberg Trial, Sobibór was mentioned only once in context with Belżec (*IMT*, Vol. VII, pp. 576).

¹⁸⁶ Eliahu Rosenberg appeared as a witness at the Eichmann Trial in Jerusalem (Session 66 of June 6, 1961), but in his testimony did not touch on his report of December 24, 1947, in any way. State of Israel. Ministry of Justice, *The Trial of Adolf Eichmann. Record of Proceedings in the District Court of Jerusalem*, Jerusalem 1993. Vol. III, pp. 1212-1215. The report in question is also not mentioned by A. Donat in his biographical notes to E. Rosenberg (*op. cit.* (note 4), p. 289).

¹⁸⁷ Elias Rosenberg, *Tatsachenbericht. Das Todeslager Treblinka*, Vienna, December 24, 1947. The document was printed on p. 133f. in facsimile by Hans Peter Rullmann in *Der Fall Demjanjuk. Unschuldiger oder Massenmörder?*, Verlag für ganzheitliche Forschung und Kultur, Viöl 1987. The passage cited appears there on p. 136 (p. 4 of the report).

¹⁸⁸ The ‘report’ of April 25, 1945. PS-1553.

¹⁸⁹ Léon Poliakov, *Harvest of Hate*, Holocaust Library, New York 1979, p. 196.

Two years later, Gerald Reitlinger took up Poliakov's claims in his work *The Final Solution*,¹⁹⁰ which rapidly became the classic of official historiography and thereby ultimately asserted diesel exhaust gases as *the* extermination method in the 'eastern extermination camps.'¹⁹¹

Therefore it owes mainly to the 'Gerstein Report' that Treblinka, just like Bełżec and Sobibór, received its diesel engine, and the steam chambers were banished to the junk yard of history.

By means of this propaganda maneuver, official historiography raised the carbon monoxide chambers of Treblinka (as well as of the two other 'eastern extermination camps') at last to the status of 'certain historical fact.'

¹⁹⁰ G. Reitlinger, *The Final Solution. Hitler's Attempt to Exterminate the Jews of Europe 1939-1945*, Vallentine, Mitchell, London 1953, pp. 140-142; p. 148f. in the 1987 edition, note 180.

¹⁹¹ This clearly did not prevent Lord Russell of Liverpool from writing even in 1954 that in Treblinka there had been committed "massacres by means of two methods, steam and gas-sing": *The Scourge of the Swastika*, Cassel & Company Ltd., London 1954, p. 242.

Chapter III: Investigations, Camp Plans, Statistics

1. Soviet Investigations and Forensic Examinations

In the middle of August 1944, the 65th Soviet Army conquered the region around Treblinka. The Military Examining Judge of the Military Office of Prosecution, First Lieutenant of Justice Jurowski, went to work immediately, supported by other officers – Major Kononyuk, Major V.S. Apresian, First Lieutenant F.A. Rodionov, Major M.E. Golovan, and Lieutenant N.V. Kadalo – and conducted investigations on the grounds of the camps Treblinka I and Treblinka II between August 15 and 23. He furthermore questioned witnesses: Samuel Rajzman, Lucjan Puchała, Marianna Kobus, Stanisław Zdonek, Barbara Zemkiewicz, Józef Pukaszek, Stanisław Kon, Mieczysław Anyszkiwicz, Tadeusz Kann, Franciszek Wesolowski, Max Lewit, and Kazimierz Skarzyński.¹⁹²

On August 22 and 23, the Soviet investigative committee, accompanied by local Polish officials, went to Treblinka to carry out investigations on the spot. Three mass graves and 13 individual graves were discovered. The exhumation of the bodies yielded the following picture:

1. Grave 10 m × 5 m × 2 m in dimension, with 105 bodies, which had been buried in layers of 5 to 7 each. Upon each layer of bodies, a layer of earth 45 to 50 cm thick had been piled.¹⁹³

2. Grave 10 m × 5 m × 1.9 m in dimension, with 97 bodies in layers of 5 to 6 bodies respectively, with layers of earth 50 cm thick interposed.¹⁹⁴

3. Grave 10 m × 5 m × 2.5 m in dimension, with 103 bodies in layers of 5 to 6 each, with layers of earth 50 cm thick interposed.¹⁹⁵

On August 24, 1944, a commission composed of the Soviet officers previously named as well as representatives of the local Polish authorities produced the first official report concerning the camps Treblinka I and II. Regarding Treblinka II it states:¹⁹⁶

¹⁹² GARF, 7021-115-11, pp. 15-43.

¹⁹³ Document No. 1, undated but clearly compiled on August 22 or 23, 1944. GARF, 7021-115-11, p. 1.

¹⁹⁴ Document No. 2, August 23, 1944. GARF, 7021-115-11, p. 2.

¹⁹⁵ Document No. 3, August 23, 1944. GARF, 7021-115-11, p. 3.

¹⁹⁶ Document, August 24, 1944. GARF, 7021-115-9, pp. 103-110.

“The camp Treblinka II was an enormous death combine. The entire Jewish population of all the nations of Europe occupied by the Germans, was brought here for burning, besides many ‘unfit’ people of other nationalities. The death factory in which the SS men ruthlessly and zealously exterminated millions of people was in operation around the clock for 13 months, from July 1942 until September 1943. This diabolical undertaking ceased to exist only after the prisoner revolt in the Jewish camp.

Dozens of witnesses attest to having seen how up to three transports of Jews, with 60 cars each, arrived in the camp on a daily basis. The trains left the camp either loaded with sand or empty.

Martyrs of the camp who survived recount that they were delivered in railway cars in which there were 150, 180, or even 200 persons each. While traveling they were dying of hunger. There was no water. They drank urine. [...]

At the railway branch line at Treblinka there was something in the camp which resembled a fine train station; the length of the platform was reckoned for 20 cars. All special buildings, where people were murdered, were carefully camouflaged on the outside as beautiful facilities. The avenues were sprinkled with sand and bordered by flowers, garden beds and fir trees – all this in order to deceive the ‘passengers.’ [...]

Some persons, who escaped the pyre through a miracle, have portrayed the nightmarish images of the incineration of people:

The Jews delivered to the camp were received by the SS unit. The men were led to a special square, but the women and children were taken to the barracks. Beautiful and young Jewesses were taken by the Germans for themselves for a night. All men, women, and children were told to undress. The women’s hair was shorn and it was sent to Germany as raw material. The clothes were sorted and likewise sent to Germany. The victims were ordered to take along valuables – gold, paper money, documents. The naked people were shown to a cashier’s counter one by one, and they were told to deposit everything. After they had done this, they were allowed to go on and were led along the sand-strewn, flower-bordered avenue into the ‘bath,’ where they were given soap, a towel and underclothing. After depositing of the valuables, already on the way to the ‘bath,’ the polite tone gave way to roughness. Those who were walking were urged on by rods and beaten with canes.

The ‘bath’ was a house, which consisted of 12 cabins, each 6 × 6 m in size. 400 to 500 people were driven at a time into one cabin. It had two doors, which could be sealed hermetically. In the corner, between ceiling and wall, were two openings connected with hoses. Behind the ‘bath’ stood a machine. It pumped the air out of the room. The people suffocated within 6 to 10 minutes. The second door was opened and the dead were brought on wheelbarrows to the special ovens.

In these, important scholars, physicians, teachers, musicians, the relatives of noted personalities were cremated. In such a way the sister of the famous psychiatrist Sigmund Freud, the brother of the French Minister Sourez [?] and others were incinerated. (Witness testimony of Abe Kon, Hejnoch Brenner, Samuel Rajzman).

A huge area of the camp was covered with cinders and ashes. The road, which connected the two camps and is three kilometers long, was covered with cinders and ashes to a height of 7 - 10 cm. One could recognize the presence of lime in large pieces of cinder with the naked eye. It is well known that lime is a product of burning bones. There were no production sites in the camp, but cinders and ashes were brought out of the camp every day by the ton. This freight was loaded onto railroad cars, and 20 to 30 peasant carts distributed them and poured them onto the road. (Witness testimony of Lucjan Puchala, Kazimierz Skarzinski. Stanislaw Krym inter alia).

The statements of the witnesses, the book 'A Year in Treblinka' [by Jankiel Wiernik], the presence of a large quantity of ashes and cinders, the presence of personal belongings and documents strewn on the grounds as well as excavated from the pits confirm that there were ovens in the camp where people were cremated. In the beginning, the Germans buried the bodies of the murdered. After Himmler had visited the camp, the bodies were dug up with an excavator and cremated.

At present it is difficult to uncover the traces and secrets of this oven for the cremation of people, but based upon the available data, one can picture it.

The oven – this was a large trench 250-300 m in length, 20-25 m in width and 5-6 m deep, excavated by an excavator. Driven into the bottom of the ditch were three rows of reinforced concrete posts, one-and-a-half m in height each. The posts were connected to one another by cross-beams. On these cross-beams rails were placed at intervals of 5 to 7 cm. That was a gigantic oven grill. A narrow-gauge spur track led down to the edge of the trench. (Witness testimony of Abe Kon, Hejnoch Brenner, Samuel Rajzman, and the content of the book 'One Year in Treblinka'). [...]

The Germans attempted to delete the traces of their atrocities. After the revolt of the Jews they destroyed all camp buildings, which were still intact after the fire. Oats, rye, and lupines were now planted on the grounds of the former 'death camp.' What remains are the walls of the burned residential building and of the cattle stall of the colonist Strebel, who was settled on the territory of the camp. Remaining as marks of the existence of the camp are: an abatis of barbed wire, ashes, cinders, and a great number of pits, where household possessions of the cremated Jews have been buried."

The report ends with six “conclusions,” of which the most important is the first:

“On the basis of the preliminary facts, the cremation of people has been determined beyond a doubt. The extent of the extermination of human beings was monstrous: about three million.”

On September 11, a “Report of the front-line press TASS” was issued, bearing the title “The Death Camp in Tremblinka” (sic). We reproduce the most significant excerpts:¹⁹⁷

“Tremblinka! At this word people tremble and look fearfully sideways. People who lived in the vicinity of Tremblinka could not sleep at night: the screams of the men, women, and children whom they were murdering ripped through the darkness. The stench penetrated from there. They were burning people there. [...]

Tremblinka – that is the same as Majdanek. It is one of the numerous factories of death, with which the Germans thickly covered Polish soil.

The ‘Tod-Lager’,^[198] as the Germans themselves officially called it,^[199] was established close to Tremblinka sometime in June 1942. [...] By the beginning of July, the first transport arrived, filled to bursting with people – with ‘living raw material,’ as the doomed were officially called. The camp gate opened to the sound of a lively march, and the stream of living people poured inside. From this point on, this stream was uninterrupted for two years. The voracious gate consumed up to two thousand people daily. [...²⁰⁰] A fat Unterscharführer sent the human chain into the ‘bath.’ This was a low square room without windows, with a heavy entrance door. A large hose, through which gas was carried, led into the ‘bath.’ The people were forcibly pushed into the ‘bath,’ the door was tightly closed with a steel bar, the Unterscharführer gave a signal, and the ‘bath-master’ switched on the machinery of death.

In the beginning, the ‘bath’ had three compartments and could hold 1,200 people. The Germans, however, were not satisfied with this capacity, and they quickly constructed a new building three times as large. Here there were 8 chambers, and the bath could accommodate 4,800 people at a time. The people in the ‘bath’ died under horrible tortures after ten minutes. The ‘bath-master’ recorded this by means of a small glass window in the door. Here, every minute was costly – after all, thousands of other people were waiting their turn. For this reason, the ‘bath’ functioned with German thoroughness. Those for whom there was no room were beaten dead or flung onto the pyre alive.

¹⁹⁷ GARF, 7021-115-8, pp. 217-221.

¹⁹⁸ In the German language.

¹⁹⁹ Even if this had been so, the Germans would have called it “Todeslager,” as “Tod-Lager” is a construction which would never be used by a German speaker.

²⁰⁰ In the manuscript “up to 7,000 people” originally appeared, but this was corrected by hand.

The corpses were retrieved from the 'bath' by a special squad; they were stacked upon rails which ran across wide pits. In the pits a fire burned that was never extinguished. This was the final stage of the 'processing.' The corpses were cremated and the human ashes were brought to Germany to fertilize fields. Even the roads inside the camp were sprinkled with it. [...]

K. Egrov

1. Byelo-Russian Front

September 12

Tass Special Correspondent"

On the 15th of September, a Polish-Soviet commission, consisting of Magister P. Sobolevski, the Secretary of the Polish-Soviet Commission for the Investigation of German Crimes, M. Chodzko, the representative of the information and propaganda department of a Polish institute, as well as G.E. Levakov, the representative of the War Soviet of the 2nd Byelorussian Front, authored a "protocol of a provisional preliminary investigation and reconnaissance in the former concentration camp Tremblinka," in which the recent investigations of Soviet military justice were summarized, and from which we cite several excerpts:²⁰¹

"[...]The site of Tremblinka lies 7 km from the railway junction of Malkinia in the Sokolowski district. The German bandits built a railway line to the place where the camp was located, in order to be able to bring the transports of prisoners directly and unobserved into the concentration camp.[...]

The concentration camp Tremblinka consisted of two sections, which were at a distance of one-and-a-half kilometers from each other. The first section was named 'Death Camp No. 2.' This camp itself, on whose grounds two burned-down farm buildings can now be found, was divided into two parts, and a railroad track led to this Camp No. 2. Here, something along the lines of a train station was constructed in order to disguise the actual mission – the extermination. A three-fold barbed wire entanglement was camouflaged with tree branches. For this reason the people taken here believed initially that they were at a transit point on their journey to the east. In the first section of Death Camp No. 2, the prisoners who had been delivered there had to undress. They were instructed to deposit their clothing at a certain place, and then forced to run naked with arms raised in the direction of the so-called bath. This was only a sham bath; it was actually a gas chamber consisting of three rooms. In the beginning, the method of pumping the air out of rooms by means of a small auto engine was employed. Then, as a result of the great number of those destined for death, they began to use chemicals. About 400 people could be crowded into this space at a time. On the roof of this – hermetically sealable – building was a small

²⁰¹ GARF, 7021-115-11, pp. 43-47.

window, through which the death struggle of the dying could be observed. [...] Approximately 400 Jews worked at this chamber; they dragged out the corpses of the asphyxiated and threw them into enormous trenches which were located in the area of Death Camp No. 2 and which had been prepared beforehand and dug out by an excavator.

In the winter of 1943, the German murderers proceeded to exhume and burn the corpses. For this purpose they also used an excavator. The personal documents found here, torn into pieces and thrown away, prove that citizens of Poland, of the Soviet Union, of Czechoslovakia and other nations, members of the intelligentsia as well as simple workers, were killed here.

The second section of the concentration camp was named 'Camp No. 1' and was located one-and-a-half kilometers away from the Death Camp. [...]

The objects found bear witness to the fact that here men, women, and children of every age were interned in entire families. The things found, such as violin parts, children's toys, devices for waving the hair [hair curlers], books and the like, show that many came to this place who did not suspect their journey's destination. Pieces of burned and destroyed passports confirm that citizens from Poland, the USSR, Czechoslovakia, and other nations occupied by the Germans were interned here."

On September 24, the Soviet investigative commission drew up the first official plan of the camp Treblinka.²⁰²

2. Polish Investigations and Forensic Examinations

After the conclusion of the previously described investigations, the Treblinka matter was allowed to rest for more than a year. But the preparations for the Nuremberg Trial awakened the interest of the Jewish Central Historical Commission as well as of the Polish State Prosecutor's office in that camp. On November 6, 1945, the latter carried out an inspection trip to Treblinka, which included: Rachel Auerbach and Józef Kermisz as representatives of the said Jewish Commission, Judge Zdzisław Łukaszkiwicz, State Prosecutor J. Maciejewski, surveyor K. Trautsolt, the witnesses Samuel Rajzman, Tanhum Grinberg, Szimon Friedman, and M. Mittelberg – all members of the Association of Former Treblinka Inmates – J. Słebczak, president of the district council of Siedlce, Major Jucharek from the neighboring village of Wólka Okrąg-

²⁰² See section 4.

lik, and finally photographer Jakob Byk.²⁰³ In January 1946, R. Auerbach described the inspection as follows:²⁰⁴

“Our car came to a stop. We got out: this was where the camp area began. According to our measurements, it is 15 hectares. A well-paved road runs parallel to the railroad tracks for about 1½ kilometers and then comes to a dead end. Another road branches out from it and comes to an end even sooner. The surface of both roads contains a weird mixture of coal and ashes from the pyres where the corpses of the inmates were cremated. The second road leads in the same direction as the ‘Road to Heaven’ of which no trace is now left. Just a bit of the concrete foundations of a horses’ stable – this is all that is left today of the camp buildings, the barbed wire fences, the barracks, the watchtowers, the gas chambers. Some of the buildings were burned down by the uprising, and the rest were carried off by human scavengers from neighboring villages after the arrival of the Red Army.

While the Germans were still here, the whole area had been plowed up and sown with lupine grass. And the lupine grass really grew and covered the whole surface with a green mask. It looked as if all the traces of the crimes had been wiped away. But since then, during the past year, the human jackals and hyenas have been coming to the burial ground and here is the picture that we saw:

Here and there, like patches of grass near the seashore, half-covered by the shifting sands, there were still little clumps of withered lupine. Not one level place in the whole area. Everything had been torn up and dug up, little hills and holes. And upon them, beneath them and among them, all sorts of objects. Aluminum kettles and pans, enameled tin pots – blackened, dented, full of holes. Combs with teeth broken off, half-rotted soles from ladies’ summer sandals, broken mirrors, leather briefcases. All this is near the station platform where the camp’s first barbed wire fences had been.

We began our tour at the place where the transports had been unloaded and we continued on the road which the Jews who were brought here had followed. What we saw here was the remnants of the Treblinka ‘Werterfassung’. Remnants of the huge piles of Jewish property, which had been packed up and sent away, incinerated, cleared off, and yet still could not be completely cleared away. It was not possible to clear away every trace of what the hundreds of thousands of people who had passed through here had experienced. Here was the physical evidence, here were the corpora delicti [...]

²⁰³ A. Donat, *op. cit.* (note 4), p. 19.

²⁰⁴ R. Auerbach, “In the Fields of Treblinka,” *op. cit.* (note 29), pp. 70-72. according to A. Donat, the trip took place on November 7, 1945, while Judge Łukasziewicz names November 6 as the date (see below).

But the physical evidence was not limited to objects. As we moved farther into the grounds, we walked over a field which was sown with human bones.

The bombs had revealed the contents of the desecrated soil. Leg bones, ribs, pieces of the spine, skulls big and small, short and long, round and flat.

Skulls!...

If only we could get an ethnologist to come here!

He could have made the most accurate anthropological measurements on the racial features of the Jewish people. [...]

We were now standing where the gas chambers had been, the huge mass graves and the pyres. In some places, the smell of death was still mingled with the odor of fire. Indeed, here and there we could see little piles of white ashes along with blackened bones, heaps of soot. All this had been buried several meters deep in the soil, mixed with sand and covered with more sand, but the explosions had brought it to the surface again. In one place the simultaneous explosion of several bombs had created a huge crater. Deep down in the hole, some outlines could be dimly seen through the fog.

'Those aren't just bones,' explained the District Attorney. 'There are still pieces of half-rotted corpses lying there, bunches of intestines.'

By now, the district attorney and the judge knew every nook and cranny here. They had been conducting their investigations for some time. They had examined both Jewish and non-Jewish witnesses, taken measurements and carried out minor excavations."

Judge Łukasziewicz had gone to Treblinka in order to perform an official investigation of the scene of the crime. As he later explained, he acted²⁰⁵

"[...] at the request of the State Prosecutor of the District Court in Siedlce of September 24, 1945, further induced by a letter of September 18, 1945, of the Main Commission for the Investigation of the German Murders in Poland."

After bidding farewell to the visitors, Łukasziewicz set to work with a group of workers. Between November 9 and 13, he undertook a thorough examination of the grounds as well as a series of excavations. Afterwards he composed an official protocol, which in view of its significance we reproduce in full:²⁰⁶

"Protocol of the tasks performed on the grounds of the death camp Treblinka, which forms the object of the judicial examination.

From November 9 to 13, 1945, the examining magistrate of Siedlce, Z. Łukasziewicz, together with the State Attorney for the District Court of

²⁰⁵ USSR-344. GARF, 7445-2-126, p. 319 (p. 1 of the report).

²⁰⁶ Reproduction of the document in S. Wojtczak, *op. cit.* (note 60), pp. 183-185.

Siedlce, J. Maciejewski, performed the following tasks on the camp grounds:

November 9, 1945

Excavations were begun on the grounds using the services of 20 workers who had been mustered by the village administration for carrying out roadwork. The excavations began at the location described by the witness Rajzman on November 6, where the so-called 'camp hospital' had stood and where, according to the witness, a mass grave is supposed to exist. Since a bomb crater 4 to 5 meters deep is present at the said location – two bombs still lie at a slight distance from this crater – the digging was begun in this crater. In the course of this work numerous Polish, as well as Russian, German, Austrian, and Czech coins and broken pieces of various kinds of containers were discovered. At the end of the work, at approximately 3 pm, at a depth of 6 meters, we encountered a layer which had not been reached previously. No human remains were found.

November 10, 1945

The work was continued, with 36 workers who had been commandeered for roadwork. At a depth of 6 meters begins a layer which has never before been uncovered by anyone. It consists partly of all sorts of kitchen utensils and different kinds of household objects; there are also pieces of clothing. At a depth of 7 meters, we reached the bottom of the pit – a layer of yellow sand which is not mixed with gravel. By additional digging we succeeded in determining the shape of the pit. It has sloping walls, and the bottom measures about 1.5 meters [sic!]. The pit was presumably dug out with an excavator. During the course of the excavations, numerous more or less badly damaged Polish documents were discovered, in addition the badly damaged personal identity card of a German Jew, as well as several more coins: Polish, German, Russian, Belgian, and even American. After we had made certain that this pit, filled with broken pieces of the containers already mentioned, ran in a north-south direction on the grounds of the camp area – 2 meters more [in a northerly direction] had been excavated – the workers started work at this location.

November 11, 1945

A series of test excavations was performed at the place where the [gas] chambers had to have been located, in order to find their foundation walls if possible. Pits 10 - 15 meters in length and 1.5 meters deep were dug, uncovering undisturbed layers of earth.

The largest of the craters produced by explosions (numerous fragments attest to the fact that these explosions were set off by bombs), which is at maximum 6 meters deep and has a diameter of about 25 meters – its walls

give recognizable evidence of the presence of a large quantity of ashes as well as human remains – was further excavated in order to discover the depth of the pit in this part of the camp. Numerous human remains were found by these excavations, still partially in a state of decomposition.^[207] The soil consists of ashes interspersed with sand, and is of a dark gray color, granulous in form. During the excavations, the soil gave off an intense odor of burning and decay. At a depth of 7.5 meters the bottom was reached, which consisted of layers of unmixed sand. At this point the digging was stopped.

November 13, 1945

With the assistance of 30 workers employed for roadwork, the opening of a pit was begun – a site where refuse was deposited in the northeastern section of the camp. In this location, as the workers from the nearby hamlets explained, a very large number of documents had been found so far. Work was begun at this location, where the people [of that area] had dug a three-meter-deep pit in a search for gold. During the course of the digging, broken pieces of all sorts of kitchen containers as well as a large number of rags were found. Aside from the coins discovered so far, Greek, Slovakian, and French ones were found, as well as documents in Hebrew and Polish and remnants of a Soviet passport. At a depth of 5 meters the work was stopped due to the steadily worsening weather conditions.

*The Examining Judge
Łukasziewicz*

*The State Attorney
Maciejewski*

Decision:

The Examining Judge of Siedlce, on November 13, 1945, rules in consideration of the fact that with great probability no mass graves are any longer to be found on the grounds of the former camp today, as is to be concluded from the witness testimonies examined so far and from the results of the work carried out at the site, and in consideration of the oncoming autumn, the present rainfall and the necessity of a rapid conclusion of the judicial preliminary investigations, in view of all these facts that work on the territory of the former death camp Treblinka is to stop.

*The Examining Judge
Łukasziewicz.”*

On December 29, 1945, after the conclusion of his preliminary investigations, Łukasziewicz issued a protocol with 14 paragraphs, which – as already mentioned – was presented by the Soviets at the Nuremberg Trial as Document

²⁰⁷ “stanie rozkladu”

USSR-344. In the third paragraph, which bears the title “Current condition of the camp terrain”, it says the following:²⁰⁸

“With the assistance of an expert surveyor and witnesses, I made an exact inspection of the terrain. According to the measurements, the area of the camp is approximately 13.45 hectares and had the shape of an irregular quadrilateral. No remnants of facilities of the former death camp exist any longer. The only things that remain of the structures are: a ditch with remains of burned wooden poles protruding up, which lead into the cellar, wall bricks from the foundations of the camp’s domestic economics building and the site of the well. Here and there one finds traces of the burned-out wooden poles of the fence and remains of barbed wire. There are still a few sections of paved walks. Nonetheless, there are still other traces that hint at the existence and functions of the camp. In the northwestern section of the area, the surface is covered for about 2 hectares by a mixture of ashes and sand. In this mixture, one finds countless human bones, often still covered with tissue remains, which are in a condition of decomposition. During the inspection, which I made with the assistance of an expert in forensic medicine, it was determined that the ashes are without any doubt of human origin (remains of cremated human bones). The examination of human skulls could discover no trace of wounding. At a distance of some 100 m, there is now an unpleasant odor of burning and decay. In the southwestern direction, a portion of the camp terrain is covered by aluminum – enamel – glass and porcelain dishes – kitchen utensils – hand luggage – rucksacks – pieces of clothing, etc. There are innumerable holes and craters on the property.”

Łukasziewicz summarized the investigations carried out a month earlier at that location as follows:²⁰⁹

“During the work on the terrain, I found no mass graves, which, in connection with the statements by the witnesses Romanowski and Wiernik, leads to the conclusion that nearly all of the bodies of the victims were burned, all the more so since the camp was liquidated early and the murderers had much time. The ground of the camp was ploughed and sown. Ukrainians were settled there; they fled before the arrival of the Red Army (witnesses Kucharek and Lopuszyński).”

On August 9 and 10, 1946, Łukasziewicz, along with the surveyor Trautsolt and the court physician Wakulicz, searched for mass graves in the area of the camp Treblinka I. In the forest by the village of Maliszewa, about 500 m south of the camp, a total of 41 mass graves were found, of which 40 had been desecrated; many bodies were strewn around them. One grave was only partially violated, and from it 10 corpses were able to be recovered. The court physi-

²⁰⁸ USSR-344. GARF, 7445-2-126, pp. 19a-20 (pp. 3f of the report).

²⁰⁹ *Ibid.*, p. 324a (p. 12).

cian examined 112 skulls and determined that in only two cases had a shot in the head been the cause of death. The entire surface area of the graves amounted to 1,607 m². Concerning the number of the bodies discovered, Łukaszkiwicz wrote:²¹⁰

“Due to the destruction of the graves, it is not possible to count the bodies which have been there. The medical expert Mieczysław Piotrowski affirms, however, that one grave of 2 × 1 × 1 m (without taking into consideration the upper level of earth which covers the bodies) contains at least 6 nude bodies. Considering the size of all 41 graves, and under the assumption that the levels of corpses reach only up to 1.5 m in depth (the depth of the graves is up to 3 m), one can calculate that at least 6,500 people were buried there.”

On this occasion, the surveyor Trautsolt drew a map of the area of Treblinka I, on which he indicated the exact position of the graves.^[211] Of these, 17 were aligned in a row in a north-south direction; their total length was approximately 510 m.

This report provokes the following reflections:

1. It may well be that a grave of 2 m × 1 m × 1 m *can* hold up to six bodies, but these measurements correspond to an entirely normal single grave. If one wished to dig mass graves, these would not have been merely one meter wide. Until evidence to the contrary, it is therefore to be assumed that such a grave contained only one body.
2. These (mass) graves could have been violated only in the period between October 1944 and August 1946, thus by the Poles, the Soviets, or by both simultaneously – but why?
3. If merely the remains of 122 people were found there, as the Polish judge remarks, where, then, were those of the other ca. 6,400?

The likeliest supposition would be that the bodies were dug up by the local authorities and buried at the cemetery of the nearby village, possibly also in the vicinity of the camp, where there is still a cemetery today. In this case, it would of course have been strange that Łukaszkiwicz had heard nothing of it. But there is yet another, more disturbing explanation, to which we shall later return: the alleged violation was presumably done in order to be able to exaggerate the number of victims of Treblinka I. If one takes the three mass graves found by the Soviets in August 1944 by way of comparison, then the 41 graves, at the same density, would have been able to hold at most 3,000 bodies. On the other hand, Łukaszkiwicz carelessly wrote in his report of December 29, 1945, that²¹²

²¹⁰ Z. Łukaszkiwicz, “Obóz pracy w Treblince,” in: *Biuletyn Głównej Komisji Badania Zbrodni Niemieckich w Polsce*, III, 1947, p. 120. Cf. also S. Wojtczak, *op. cit.* (note 60), p. 135.

Wojtczak claims that according to the expert Piotrowski the graves contain 10,000 bodies.

²¹¹ See Document 6 in the Appendix.

²¹² USSR-344. GARF, 7445-2-126.

“in this camp [Treblinka I] approximately 50,000 Poles and Jews were killed.”

One further question suggests itself: Who were the dead in Treblinka I? It is known with certainty that a typhus epidemic was raging in that camp in the fall of 1943. In fact, a list was kept with the names of 148 prisoners, most of whom had succumbed to this illness from November 12 to December 20, 1943.²¹³ The epidemic had broken out some months before, and for this reason a car with 11 tons of calcium hypochlorite was sent to Treblinka I on September 20 from the concentration camp at Lublin (Majdanek), which obviously was to be scattered on the layers of bodies.²¹⁴

Since around 10,000 prisoners were interned in Treblinka I during the time of its existence,²¹⁵ one can assume that the mass graves uncovered by the Soviets and Poles contained the bodies of all – or nearly all – who died there. That is, further graves or traces of mass cremations were not found.

3. Assessment of the Investigations

In her previously cited report, Rachel Auerbach spoke pompously of “physical evidence” and “*corpora delicti*.” But in fact neither the Soviets nor the Poles uncovered even the slightest scrap of proof that Treblinka II operated as an extermination camp. The Soviets, in their report of August 24, 1944 – cited in section 1 of this chapter – were compelled to make the following admission:

“At the present it is difficult to uncover the traces and secrets of this oven for the cremation of people, but based upon the available data, one can picture it.”

Even the investigations performed by Łukaszkiwicz proved to be a complete failure in terms of this central question. He arranged excavation at a definite spot in the camp where, according to the witness S. Rajzman, a mass grave was located, but discovered nothing of the kind. He had trenches dug, 10 to 15 m long and 1.5 m deep, at the places where, according to witnesses, the two alleged gassing buildings had stood, yet merely encountered “undisturbed layers of earth.” To be sure, he did find skulls, but without gunshot wounds. All the evidence he examined (coins, documents, rags, containers, remnants of various objects) show merely that there was a camp at that place, and the human remains as well as the ashes prove only that bodies were buried or cremated in the camp. Nothing produced even a trace of evidence for mass murder, to say nothing of such a crime against *several hundred thousand* people.

²¹³ Reproduction of the document in S. Wojtczak, *op. cit.* (note 60), pp. 159-164.

²¹⁴ J. Gumkowski, A. Rutkowski, *Treblinka, op. cit.* (note 77), reproduction on unnumbered page.

²¹⁵ *Informator encyclopedyczny, op. cit.* (note 64), p. 528.

Among the objects discovered, the skulls as well as the human body parts found in a state of decomposition deserve particular attention. From whom did they come? If we subscribe to the official historiography, this question remains unanswered. According to the official version, the cremation of the bodies exhumed from the mass graves was finished by August 2, 1943, the day of the prisoner revolt. During this revolt, at least 300 to 400 prisoners are supposed to have been killed within the camp or in the vicinity of the wire fence,²¹⁶ and in the following three weeks, allegedly more than 30,000 Jews from the ghetto of Białystok were gassed, whose bodies neither the Soviets nor the Poles discovered. If there were such killings, these victims therefore must have been cremated. The same is true for the bodies of those killed in the revolt. The surviving prisoners were not killed on the spot, rather they were transferred to Sobibór on December 20, 1943, as can be gathered from a corresponding Wehrmacht bill of lading.²¹⁷ If decomposing body parts were found in November 1945, this discovery is also inconsistent with the thesis that the victims involved had been murdered more than two years before. Finally, it is strikingly problematic that no single *complete* body was discovered.

From whom, therefore, did the skulls and body parts come? Were they perhaps taken from the mass graves of Treblinka I? Could these have been the remains of victims of the typhus epidemic, which had raged in the camp at the end of 1943? This hypothesis seems all the more plausible in that none of the skulls exhibited gunshot wounds. It could also furnish an explanation for the odd circumstance that Treblinka II was bombed: the bombs destroyed not only the two buildings, which in all probability had been left intact by the Germans,²¹⁸ but also scattered rotted body parts over a wide area and thus increased the horrible effect of the ‘extermination camp’. In fact, the discovered body parts were thoroughly exploited for propaganda.

4. Plans of Treblinka

On his inspection of the area of the former camp Treblinka II of November 9 to 13, 1945, Łukasziewicz was accompanied by the sworn surveyor K. Trautsolt. With the help of witnesses, Trautsolt drew an accurate plan of Treblinka II as it was at that time.²¹⁹ The plan, whose directional axes are trans-

²¹⁶ Y. Arad, *op. cit.* (note 71), p. 298.

²¹⁷ Reproduced in Z. Łukasziewicz, *Obóz straceń w Treblince*, *op. cit.* (note 38), p. 61.

²¹⁸ Both buildings are clearly visible on an aerial photograph of November 1944, thus after the occupation of the area by the Red Army, but it is not clear whether they are intact or partially burned out: U.S. National Archives, Ref. No. GX 12225 SG, exp. 259; the exact date of the photograph, which was published by John C. Ball for the first time, is unknown, cf. Photograph 11 in the Appendix.

²¹⁹ See Document 7 in the Appendix. A similar, simplified plan was reproduced by A. Neu-

posed,²²⁰ shows an irregular quadrilateral whose sides have the following lengths:

- north side (actually the east side): 376.5 m
- east side (actually the south side): 471.5 m
- south side (actually the west side): 490 m
- west side (actually the north side): 240 m

Thus, the overall area of the Treblinka II camp was approximately 134,500 m² (13.45 hectares).

On the plan the ruins, which existed in the camp area, are also entered: a burned out cellar (“*piwnica spalona*”), designated by the letter ‘e’, as well as the destroyed house of a settler (“*dom burzony kolonisty*”), marked with the letter ‘l’.

On another, typographically identical map, surveyor Trautsolt added the facilities that had allegedly been located in the camp area according to witness testimony. Łukasziewicz published two versions of this map, of which the first is quite poor,²²¹ the second of a higher quality.²²² On the latter, the (alleged) extermination zone, also referred to by many witnesses as ‘Camp II’ within Treblinka II, is exactly shown. It is an irregular quadrilateral. If one uses the sides of the camp for scale, the length of the sides of the cremation zone can be calculated:

- north side (east): 188 m
- east side (south): 110 m
- south side (west): 174 m
- west side (north): 52 m

Thus, the surface area of this zone would have been some 14,000 m² (1.4 hectares), that is, a tenth of the entire camp Treblinka II. This zone, Camp II, was the alleged death camp, the area of Treblinka II, in which the two gassing installations, the mass graves, and the incineration pits are supposed to have been located. The rest of Treblinka II, also referred to as Camp I, allegedly housed the guards, camp administration, rag sorting and collecting locations, etc.

Regarding the shape and the size of the entire camp, this plan conforms quite accurately to the aerial photographs produced over Treblinka II in May and November 1944. On the other hand, the results of the forensic examina-

maier, “The Treblinka Holocaust”, in: G. Rudolf (ed.), *op. cit.* (note 80), p. 489; cf. Document 8. As is obvious from the plan, it originates from the archive of the Main Commission for the Investigation of Hitler Crimes in Poland (Główniej Komisji Badania Zbrodni Hitlerowskich w Polsce).

²²⁰ The north-south line on the map actually corresponds to the east-west line.

²²¹ See Document 9 in the Appendix.

²²² See Document 10 in the Appendix.

tions have significantly less correspondence with what can be seen in these aerial photographs.

The air photo of May 15, 1944, shows five buildings in the northwest sector of the camp, in a trapezoidal zone of approximately 60 m × 100 m in size.²²³ In the south and east, it is bordered by a grove, in the west by the road then leading into the camp as well as by the fence existing at that time. Quite obviously, these buildings have nothing to do with the ‘farmhouse,’ which the SS is supposed to have constructed after the liquidation of the camp and in which it is supposed to have left behind a Ukrainian to watch over the zone.²²⁴

In the air photo of November 1944, one sees only two buildings still there; the three others have apparently been destroyed.²²⁵

The camp Treblinka I was evacuated on July 23, 1944,²²⁶ and the German troops withdrew from the area around Treblinka at the end of July. Thus, when the Soviets took over the camp area in August 1944, they must have found the two buildings still intact, but, as already determined, they wrote in the report of September 15, 1944, that only “two burned-down farm buildings” were still standing on the camp area. In November 1945, when Łukasziewicz came on his tour of inspection, the two buildings no longer existed. Thus they had to have been destroyed by the Soviets or the Poles between September 1944 and November 1945. For what reason? It is highly probable that the other three houses were also destroyed by the Soviets or Poles. The SS in particular would have, in any event, destroyed all five instead of leaving two of them standing. For what purpose would it have done otherwise? In order to leave behind one lonesome Ukrainian in enemy territory? What could his mission possibly have been? The story is fishy.

Nor do the anomalies end here. Łukasziewicz found several bomb craters on the camp grounds, even a couple of unexploded bombs. The largest crater was 6 m deep and possessed a diameter of approximately 25 m. Therefore the camp must have been bombed, and most surely not in error. The Germans, who according to official historiography had erased all traces of their crimes by dismantling the barracks, tearing down the walled structures, leveling and plowing the terrain and planting it with lupines, would have had no interest in bombing the camp. In the first place there was nothing left to destroy, and in the second, the craters produced by the bombs would have revealed the traces of the alleged mass murders. An aerial photograph of the camp Treblinka II taken in November 1944 further reveals that the camp at that time – after the area was taken by the Red Army – had not yet been bombed.²¹⁸

²²³ See Photograph 10 in the Appendix.

²²⁴ A. Ruckerl, *NS-Vernichtungslager...*, *op. cit.* (note 61), p. 240. This settler, who, as we have seen, was allegedly named Strebel, is supposed to have fled shortly before the arrival of the Red Army, according to the Soviet report of August 24, 1944.

²²⁵ See Photograph 11 in the Appendix.

²²⁶ S. Wojtczak, *op. cit.* (note 60), p. 130.

Thus, the bombardment must have been the work of the Soviets. But the Treblinka Camp had already been liquidated in November 1943, and there were no military targets in its immediate vicinity. Treblinka I, which was still in operation in May 1944, was *not* bombed. Why, therefore, did the Soviets drop bombs on Treblinka II? Perhaps in order to obliterate the many traces left behind by the SS, traces which could in no way be made to jibe with the thesis of mass extermination, and to lay false tracks that seemed to confirm this thesis?²²⁷

As far as the shape and size of the camp is concerned, one may regard the plans of the camp mentioned above as reliable, since they were drawn by a professional surveyor on the basis of measurements done at the site, and because they correspond well to the aerial photographs. One can therefore accept them as a standard for comparison for all plans drawn earlier or later by ex-prisoners of the camp or based upon their descriptions. With one exception, which will be discussed later, the camp continually shows the shape of an irregular quadrilateral.

On the other hand, with regard to the buildings in the camp and other facilities we are dependent entirely upon the statements of the witnesses, since not a single German camp plan has been preserved. The differences between the plans produced by former inmates are less revealing than the graphical development of the so-called 'Camp II', thus of the alleged extermination camp.

On the plan, which was included with the report of November 15, 1942,²²⁸ the entire camp is dominated by the two extermination facilities, as if the 'Camp I', the administrative sector with quarters, kitchens, storehouses etc., did not exist at all. The two steam execution installations with three or, respectively, ten chambers, which were then transformed into engine exhaust gas execution facilities by J. Wiernik on the map published in his writings of 1944,²²⁹ appear in all later plans with the same shape and in the same location.²³⁰ Thus, in the beginning, 'Camp I' was not depicted at all, and 'Camp II' consisted exclusively of the two death houses.

The first official plan of Treblinka was produced by the Soviet investigative commission on September 24, 1944. It has the shape of an irregular quadrilateral, which corresponds to the actual form of the camp only in rough features. On this plan 'Camp I' possesses a clearly outlined structure, which was later adopted by the drafters of many other plans. But 'Camp II' is still dominated by the two extermination facilities (this time with air evacuation chambers), which are called 'Bath No. 1' and 'Bath No. 2' and which correspond to the steam execution facilities of the plan of November 15, 1942. The Soviets

²²⁷ The body parts found on the camp grounds by the Poles are rationally explainable only by bomb explosions.

²²⁸ See Document 2 in the Appendix.

²²⁹ Cf. Chapter II, Section 5.

²³⁰ See Document 4 in the Appendix.

have added two further, repeatedly recurring facilities: the undressing-barracks (60 m × 12 m) as well as the path surrounded by barbed wire, which leads to the execution facility and was later baptized the ‘hose’. On his plan from 1945, J. Wiernik adopted the Soviet representation of ‘Camp I’ and augmented ‘Camp II’ with two cremation grates, two watchtowers, a gallows, several workshops (for cabinetmakers, shoemakers, metal workers), quarters for the guard detachment, prisoners’ kitchens, prisoners’ barracks, a laboratory, women’s quarters, a laundry as well as prisoners’ showers.²³¹ On this plan the mass graves are not yet shown individually. That first occurred at the Düsseldorf Treblinka Trial of 1964f., when State Prosecutor A. Spieß had an official camp plan drawn, which auspiciously displayed four “corpse pits.”²³²

The path to this ‘official’ plan was obviously very tortuous. Some plans, which arose in the immediate postwar period, show quite substantial deviations even from the copies previously described. In 1946, Arie (Aleksander) Kudlik drew a plan, in which merely the second of the two extermination facilities is to be seen in ‘Camp II’, but there are five circles designated as “crematoria.”²³³ The plan produced by the witnesses Laks and Płatkiewicz deviates even more drastically from those more familiar.²³⁴ N. Blumental, who published this drawing in 1946, described its origin as follows:²³⁵

“The copy of the plan ‘Death Camp Treblinka,’ together with the explanation relating to it, was sent to the Jewish Central Historical Commission by Moszek Laks, who was called ‘Mietek’ in Treblinka. He arrived in the camp from Suchedniów (Kielce district) on September 22, 1942. According to the statement of the witness, the plan was made by him and by Mr. Płatkiewicz during his stay in the camp. The witness took part in the revolt and then escaped into the woods with the plan. From August 2 until January 17, 1945, Herr Laks remained in hiding. His credibility is confirmed by: Maniek Płatkiewicz, who participated in the Treblinka revolt. They drew the plan while peeling potatoes in the cellar during their stay in Treblinka. The witnesses have produced the original made in Treblinka, on which basis a corresponding copy was made.”

If this is correct, the plan would have to be the most accurate of any drawn by the witnesses, for it is based not upon unaided memory, but instead upon direct observation of the camp. It is in fact the only one that depicts the form of the buildings and installations, which are numbered 1 to 53 and show diverse sub-numerations. The plan’s legend explains these buildings and installations, with short anecdotes from the camp history inserted now and then. The two

²³¹ See Document 11 in the Appendix.

²³² See Document 12 in the Appendix.

²³³ See Document 13 in the Appendix.

²³⁴ See Document 14 in the Appendix.

²³⁵ Wydawnictwo Centralnej Żydowskiej Komisji Historycznej (ed.), *Dokumenty i Materiały*, op. cit. (note 39), p. 190.

authors mention installations, which are missing from the other plans, for example the sports field for the Ukrainian guard detachment (17), the recreational space with parasols and chairs for the SS men (10), an armored vehicle always ready for action (12), the bicycle parking place (11), the gas station (15), the projecting roof for protection of the fuel containers (16), the vegetable gardens (4), the extinguishing basin (39, a water reserve for fire-fighting – ed.), the space for trucks to maneuver (44), the coal supplies (45), a false train station, consisting of a barracks with the inscription “Obermajdanki,” a clock and a placard with the inscription “Wołkowysk–Białystok Train Station,” ticket room, time table, doors to the waiting rooms of the first, second, and third class with bar, all of it phony (50/1-6), four placards with information about the type of clothing, which the Jews had to deposit there when they had undressed (wool, silk etc.), and last of all some statues: of a Ukrainian assault group advancing into battle (21), of a shepherd pasturing his animals (32), of Jews who are going to work with shovels and picks beneath the sign “To the Ghetto” (36). In the legend to the plan, there also appears an explicit reference to the mass killings – “Road to the Death Camp” – but it is the strangest thing that even this ‘Death Camp’, the ‘Camp No. II’, doesn’t appear at all on this plan, as if it were an unimportant detail. Perhaps the two artists did not yet know how many extermination facilities they were to show or how to represent them.

Samuel Willenberg rectified this deficiency more than forty years later by publishing a plan of the camp in his memoirs on Treblinka,²³⁶ in which the camp has the shape drawn by the surveyor Trautsolt, and the buildings are represented corresponding to the technique employed by Laks and Płatkiewicz. Of course ‘Camp II’ possesses those installations, which are supposed to have existed there according to the official version, *i.e.* the two alleged killing facilities, three mass graves, a cremation grate and a barrack for the Jewish prisoners.²³⁷

As we shall see in the last chapter of this book, in all probability ‘Camp II’ contained facilities of quite a different kind.

²³⁶ See Document 15 in the Appendix.

²³⁷ S. Willenberg, *Revolt...*, *op. cit.* (note 82), p. 6.

5. Number of Victims of Treblinka: Origin of the Official Figure

In the preceding chapter we have seen that the report of November 15, 1942, was already speaking of two million murdered in Treblinka to date. In his 1944 account, J. Wiernik gave no exact number, but spoke merely of “millions of people.”²³⁸ On April 24, 1944, the Soviet investigative commission placed the number of victims at three million.²³⁹ S. Rajzman, the chief witness, subdivided the number of victims by national origin. In his interview of September 26, 1944, he stated the following (the linguistic flaws here, as well, are the fault of the Soviet translator):²⁴⁰

“Daily, 3-4 transports arrived in the camp. There were, of course, days on which 1-2 transports arrived, but that was an exception, not the rule. In each transport 6,000-7,000 people of Jewish nationality arrived. Our illegal groups, as I have already said, kept careful record of all contingents that arrived in the camp. Jews from various countries of Europe were brought into the camp. 120,000 arrived from Germany itself, and among them:

<i>Austria</i>	<i>40,000</i>
<i>[Additionally:]</i>	
<i>Poland</i>	<i>1,500,000</i>
<i>Czechoslovakia</i>	<i>100,000</i>
<i>Russia</i>	<i>1,000,000</i>
<i>Bulgaria and Greece</i>	<i>15,000</i>

Thus, during the time the records were kept, and indeed from October 1, 1940 to August 2, 1943 [sic!] – there was a total of 2,775,000 men, women, old people and children, of Jewish nationality brought into the camp.”

Naturally Vassili Grossmann adopted the Soviets’ figure, three million figure.²⁴¹ In December 1945, Łukaszkiwicz attempted the first detailed accounting of the claimed alleged Treblinka victims, and in so doing introduced methods, which were to become standard procedure for the official historiography:²⁴²

“It is clear that as of now an exact statement of the number of victims is still not possible. One should take care to note that the camp in Treblinka was no longer active from the fall of 1943 and that the murderers had sufficient time to obliterate all traces. The best procedure, in my opinion, would be to determine the number of transports as accurately as possible.

²³⁸ A. Donat, *op. cit.* (note 4), p. 185.

²³⁹ See Section 1 of this chapter.

²⁴⁰ USSR-337. GARF, 7445-2-126, p. 240.

²⁴¹ W. Grossmann, *Die Hölle von Treblinka*, *op. cit.* (note 26), p. 32.

²⁴² USSR-344. GARF, 7445-2-126, pp. 323-323a (p. 9f. of the report).

Enumerations based on the capacity of the chambers would not have been accurate, since it is of course unknown how frequently they were filled and to what degree. In determining the number of transports, I have referred to the testimony of witnesses, in particular train workers, and documents of the Treblinka station. In the time span from August 1942 until the middle of December 1942, the transports were extremely numerous. In this period I am assuming, with very conservative calculations, one transport per day. (Jewish witnesses declare that most of the time there were 3 transports daily, while Polish railway workers say 2). Afterward, in the period of time from the middle of January until the middle of May 1943, the average number of transports was one per week (witnesses: Reisman [sic] and Abe Kohn [sic] even say that there were 3 transports weekly). The number of cars in one transport was determined to be 50. (It emerges from the documents that many transports consisted of 50 cars.) The number of days in a month – 30; the number of weeks in a month – 4. In this way, we arrive at the total number of 7,500 cars from August 1, 1942, to May 15, 1943.”

The author then cites some German railway documents, to which we shall return later and from which it can be seen that, from August 17 to August 23, 1943, 266 cars left Białystok for Treblinka. He continues:

“A total of 266 cars. I assume an average of 100 persons in a car. However, most of the witnesses say the number was 200. Thus, without any exaggeration, we must set the number of victims at 781,000. For illustration I add that I am able, on the basis of objective documents: telegrams, railway time-tables, bills of lading etc., to determine with complete accuracy the shipment of over 2,000 cars with Jews, although the documents mentioned represent only a small fraction of the railway documents. In my opinion, this proves that the above mentioned calculation is very conservative.”

However, the Polish judge’s claim that, according to which 2,000 railroad cars have been documented, does not correspond to reality. In the second of his two writings from in 1946, he mentions the railway documents in his possession, to wit:

- railway schedule no. 548 of August 3, 1942;
- railway schedule no. 562 of August 25, 1942;
- railway schedule no. 594 of September 21, 1942;
- railway schedule no. 552 of February 1, 1943;
- railway schedule no. 567 of March 26, 1943;
- railway schedule no. 290 of August 7, 1943;

Further:

- railway travel sheet of August 17, 1943.
- telegram of August 18, 1943.

From these documents a total of 809 cars can be counted. Two items are uncertain: the railway schedule no. 548 of August 3, 1942, in which one train per

day with 58 cars is announced, and the railway schedule no. 552 of February 1, 1943, in which 6 transports with 12,000 persons are mentioned, but with no indication as to the number of cars. Assuming a passenger density of 100 per car, as Łukaszkiwicz does, these 6 transports, with an average of 2,000 occupants each, had an average of 20 cars per transport, so that the total number of cars was not 2,000, but $(809 + [6 \times 20]) = 929$.

In the work under consideration, Łukaszkiwicz retains his previously cited number of victims, with certain modifications. For the period of August 1, 1942, until December 15, 1942, he starts with 135 transports, which corresponds to one transport per day for 135 days. For the period from January 15, 1943 (he claims that no transports arrived between December 16, 1942, and January 14, 1943) until May 15, 1943, he assumes 16 transports (that is, 1 transport per week \times 4 months \times 4 weeks per month = 16 transports), thus a weekly transport for 16 weeks. He adds in the transports that arrived in August 1943, which he enumerates as follows:

- August 17 and 18: 2 trains with 39 cars each = 78 cars
- August 18: 1 train with 35 cars
- August 21-23: 5 trains with 38 cars each = 190 cars.

Since Łukaszkiwicz assumes that each train had an average of 50 cars with 100 occupants per car, the $(135 + 16) = 151$ transports equal $(151 \times 5,000) = 755,000$ deportees. The 303 cars of August 1943 yield 30,300 deportees, so that a total number of persons sent to Treblinka would have been $(755,000 + 30,300) = 785,000$; the author rounds this figure to 800,000.²⁴³

In the December 1945 report, he had written that on August 17, 1943, a single train of 41 cars arrived at Treblinka, but now he speaks of two trains with 39 cars each, which is surely more correct. We will return to this question in chapter nine.

While the Jewish Central Historical Commission accepted Łukaszkiwicz's drastic reduction from the Soviet number of three million, it considered the Polish judge's figure (800,000) too low. In her 1946 work, which has already been cited several times, Rachel Auerbach writes:²⁴⁴

"On the basis of the commission's findings and of our own calculations, we believe that the figure of over 3,000,000 Jews killed in Treblinka, which has been cited by various authors, is definitely too high. The true figure was probably a little over one million.

The mass executions in Treblinka began on July 23, 1942, which that year happened to be the date of Tisha b'Av (the traditional Jewish day of mourning and fasting for the Temple in Jerusalem), and definitely ended in the middle of September, 1943. The largest number of transports were brought in during the months of August, September, October, November,

²⁴³ Z. Łukaszkiwicz, *Obóz straceń w Treblince*, op. cit. (note 38), pp. 36-39.

²⁴⁴ R. Auerbach, "In the Fields of Treblinka," op. cit. (note 29), pp. 52ff.

and the first half of December, 1942. At the end of August there was a hiatus of one week because too many corpses and too much clothing had accumulated and the camp staff was unable to cope with the workload. Subtracting that one week, there still remain four and one half months, with 144 days of full 'production,' in the gas chambers. According to all the testimony that has been heard, one to three transports would arrive at Treblinka each day. Each transport consisted of an average of 60 boxcars, and each boxcar held between 80 and 150 people. According to a number of witnesses, there were days when the transports had above-average passenger loads, and the number of transports arriving was more than three. On such days the gas chambers were in operation until 1 a.m. and finished off more than 20,000 corpses within 24 hours. But on the other hand there were days when the transports were much smaller, particularly those from Germany, Czechoslovakia, and other West European countries, with the deportees arriving in passenger cars which were not so crowded (except that there were many trunks and special baggage cars). Besides, we must take into account the possibility that the witnesses might have counted each 20-car section which was brought onto the camp siding from the Treblinka station as a separate transport. [...]

Thus, we are assuming an average of one transport daily with 60 boxcars each, and 100 people in each car, for the 'busy season' of Treblinka 'production.' This would be equivalent to an average of 6,000 persons per day. Multiplied by 144 days this would yield a total of 864,000 souls.

From the middle of December, 1942 until the middle of January, 1943 – the Gentile holiday season – there was a pause in transports, a vacation of sorts. After this pause, the shipments became much less frequent. Two, or at most three, transports arrived each week. During March and April hardly any transports arrived. The last transport seen by the Jewish witnesses arrived in mid-May, 1943; it consisted mainly of people deported from Warsaw after the Warsaw ghetto uprising.

[...] We know for certainty that transports of Jews from Bialystok arrived during that period. Taking into account all the information available to us, we figure that at least 25 transports of Jews perished in Treblinka between mid-January and September, 1943 (or about the time of the uprising) and about 10 transports after the uprising – or about 35 transports in all. According to our previous estimate of average number of cars per train and deportees per car, this makes a total number of 210,000 souls. Added to the total for the 'busy season' of transports, this would yield a grand total of 1,074,000; in other words, just over one million Jews."

The verdict of the Düsseldorf Court of Assizes of September 3, 1965, devoted a separate paragraph to the question of the number of victims of Treblinka:²⁴⁵

²⁴⁵ A. Rückerl, *NS-Vernichtungslager...*, op. cit. (note 61), pp. 197f.

“In the extermination camp Treblinka at least 700,000 persons were killed, predominantly Jews but also to a lesser extent Gypsies. These findings are based upon the expert report presented by Dr. Helmut Krausnick, the Director of the Institute for Contemporary History in Munich, to the Court of Assizes. In his expert report, the expert has utilized all the resources customary in historical science and accessible to him in the German and foreign archives, among them the so-called Stroop Report [...], the protocols of the Trial of Major War Criminals before the International Military Tribunal at Nuremberg, and the incomplete official railway documents found after the war (schedules, telegrams, and travel sheets) about the transports to Treblinka, which have been the subject of the main proceedings and which the Court of Assizes has placed at the disposal of the expert.

The expert Dr. Krausnick stated the following, inter alia:

According to the Stroop Report, in the period from July 22, 1942, to October 3, 1942, approximately 310,000 and in the period from January to mid-May 1943 approximately 19,000 Jews were brought in freight trains from the Warsaw Ghetto to Treblinka.”

However, the Stroop Report actually reads as follows:²⁴⁶

“The first large resettlement action took place in the period from 22 July to 3 October 1942. In this action 310,322 Jews were removed. In January 1943 a second resettlement action was carried out by which altogether 6,500 Jews were affected.”

Thus, Treblinka is not even mentioned in this passage of the Stroop Report. The verdict further states that from August 21, 1942, to August 23, 1943, transports arrived in Treblinka with Jews (but also Gypsies) from many other Polish cities as well as Germany, Austria, Czechoslovakia, Bulgaria, Yugoslavia, and Greece. The judges go on to cite Krausnick as follows:

“An exact number of the persons taken to Treblinka in this manner, however, cannot be determined, since in regard to the rail transports in particular only a portion of the documents is available. Nevertheless, one may estimate the number of persons brought to Treblinka by freight and passenger trains – disregarding the approximately 329,000 Warsaw Jews – at about 271,000, if one assumes an average number of 60 boxcars per train, an average occupancy of 100 persons per boxcar and of 50 persons per passenger car, so that a freight train would have transported about 6,000 and a passenger train about 3,000 Jews to Treblinka.”

Since, according to Krausnick, the numbers were often higher (why, then, were they taken as average figures?), and since thousands of Jews and Gypsies are supposed to have arrived by other means of transport, according to him the total number of victims had to be higher.²⁴⁷

²⁴⁶ PS-1061. IMT, Vol. XXVI, pp. 634f.

²⁴⁷ A. Rückerl, *NS-Vernichtungslager...*, op. cit. (note 61), pp. 198f.

“For all of these reasons it would be scientifically admissible to estimate the number of the persons killed in Treblinka as at least 700,000.”

There is, however, not a lot of substance to the pompously invoked ‘science’ of this estimate. Aside from the fact that deportees are still a long way from being ‘people killed’, the number of 329,000 people deported from the Warsaw Ghetto to Treblinka, although plausible in terms of the order of magnitude, is not documented at all, while the figure of 271,000 people brought from other places into the camp is a number plucked entirely from thin air. Using the number and occupancy of cars of a deportation train serves only to simulate a basis for calculation which in reality does not exist, because the number of the deportation trains is simply not known. The figures stated by Krausnick were obviously invented, every single one of them, in order to reach the result of (329,000 + 271,000 =) 600,000. Krausnick simply adds 100,000 invented deportees, but provides no source at all for them, not even a fictitious one!

At the end of the citation from the Düsseldorf verdict quoted above, Rückerl furnishes the following reference in a footnote:²⁴⁸

“In an expert opinion given at the second Treblinka trial in the fall of 1969, the expert Dr. Scheffler came to the conclusion, based upon more recent research, that in the extermination camp of Treblinka a total of more than 900,000 people were killed, almost exclusively of Jewish descent.”

As far as we know, this expert opinion of Wolfgang Scheffler has never been published. In 1976 Scheffler wrote an article in collaboration with one Ino Arndt, in which one finds the following succinct prose:²⁴⁹

“According to the findings of the Court of Assizes in the first Düsseldorf Treblinka trial (1964-1965), which are based upon (incomplete) documents (time-tables, telegrams, railroad car travel sheet) evaluated by the specialist rendering his expert opinion, on the so-called Strop Report, on the literature, and on witness testimony, in Treblinka at least 700,000 people, predominantly Jews but also Gypsies (approximately 1,000), were killed. The expert in the second Treblinka trial (1969/70) arrived at a number, based upon the most recent research, of 900,000 victims.”

The two authors refer in a footnote to an earlier Rückerl book,²⁵⁰ in which, however – here as well in a modest footnote! – the same exact thing appears! Thus, it is clear that the reference to “the most recent results of research” does not refer to any discovery of previously unknown documents – such are in fact not mentioned – but rather exclusively to new arithmetical acrobatics with

²⁴⁸ *Ibid.*, p. 199.

²⁴⁹ Ino Arndt, Wolfgang Scheffler, “Organisierter Massenmord an Juden in nationalsozialistischen Vernichtungslagern” in: *Vierteljahrshefte für Zeitgeschichte*, Vol. 2, 1976, pp. 127f.

²⁵⁰ Adalbert Rückerl, *NS-Prozesse*, Verlag C.f. Müller, Karlsruhe 1971, p. 38.

large unknown factors (number and capacity of trains, period of the deportations).

In dealing with the number of victims, nothing better occurred to Stanisław Wojtczak, the author of the most substantially documented summary of the Treblinka literature (1975), than to accept Judge Łukaszkiwicz's hypothesis. He divides the history of the camp into three periods: during the first (July 23 to mid-December 1942), 640,000 people were murdered; during the second (January to mid-May 1943), 80,000; and during the third (August 2, 1943, to the closing of the camp), a further 30,000, therefore a total of 750,000.²⁵¹

In 1982, Uwe Dietrich Adam divided the camp history into two periods, that from July 23, 1942, to August 28, 1942, with 215,000 victims, and that from September 1942 to October 1943 with 485,000 victims, so that the total number of victims amounts to 700,000.²⁵²

In his 1987 book, Yitzhak Arad provides a detailed list of the transports to Treblinka; he is the only one to have done so.²⁵³ Since his list is very long, we restrict ourselves here to reproducing the districts of origin and the numbers:

District	Number Deported
Warsaw	365,720
Radom	364,400
Lublin	33,300
Białystok	117,970
Total	881,390

Divided according to year, Arad's data give the following picture:

1942:	824,170
1943:	57,220

An accurate classification of these numbers by month is not possible, since the waves of deportation often began during one month and ended during the next. But the following picture emerges as an approximation:

1942		1943	
July and August:	314,000	January:	28,220
September:	177,000	February:	14,400
October:	203,000	April:	3,500
November:	98,000	May:	3,500
December:	32,170	August:	7,600

²⁵¹ S. Wojtczak, *op. cit.* (note 60), pp. 151f.

²⁵² Uwe Dietrich Adam, "Les chambres à gaz," in: *Colloque de l'Ecole des Hautes Etudes en Sciences Sociales, Allemagne nazie et le génocide juif*, Gallimard-Le Seuil, Paris 1985, pp. 248f.

²⁵³ Y. Arad, *op. cit.* (note 71), pp. 392-397.

Arad names about 140 localities, from which deportations to Treblinka are supposed to have left, and supplies in each case the exact number of the deported. Upon what source does he rely in doing this? He refers to censuses of the Jewish Councils in general, to memoirs and diaries of survivors, some Jewish studies and “documents of the German railway administration”, concerning which he explains:²⁵⁴

“If we consider that each fully loaded boxcar transported 100 to 150 people, we are able to determine the approximate number of the Jews taken along in each transport.”

With this we wind up once again with Judge Łukaszkiewicz’s method!

In fact Arad – without admitting it – relies principally on Anglo-Jewish historian Martin Gilbert’s *Atlas of the Holocaust*, first published in London in 1982. This work contains an abundance of numerical data about the deportation of Jews but maintains a total silence on the sources. Gilbert’s figures for Poland – and, in particular, the deportations to Treblinka – are for the most part the product of fantasy: he has done nothing more than assign numbers snatched out of thin air to individual locations from which real and imagined transports departed; numbers whose total adds up to the predetermined figure, 840,000!²⁵⁵ Even a fleeting glance at the tables shows this beyond a doubt. For example, table 168 shows approximately sixty locations of the Białystok district, from which transports are supposed to have departed for Treblinka on November 2, 1942. To this endless column of mostly unknown small country towns Gilbert allots extremely exact numbers of deportations.²⁵⁶ If there had really been precise figures for these small towns, they would naturally have been cited first and foremost by the Polish researchers and historians; but, as we have seen, the latter had to confine themselves to hypothetical enumerations of trains and cars.

This means Gilbert’s data on the transports to Treblinka were for the most part products of his fantasy and are devoid of scientific value. Exactly the same thing applies to Arad’s transport lists, which are based upon Gilbert’s book.

In 1995, a little book appeared from the pen of one Manfred Burba, which contained statistics and a bar graph indicating the number of Treblinka victims. Arranged by district and nation of origin, the numerical portion appears as follows:²⁵⁷

²⁵⁴ *Ibid.*, p. 381.

²⁵⁵ M. Gilbert, *Atlas of the Holocaust*, William Morrow and Company, New York, 1993, map No. 217, p. 167.

²⁵⁶ *Ibid.*, p. 133. Here a few examples: Wasosz: 50; Gonadz: 1,280; Lubotyn: 174; Wasilków: 1,180; Mocki: 756; Kłukówo: 68, etc. For some places he gives much higher numbers: Bielsk: 5,000; Suchowola: 5,100; Krynki: 5,000; Siematyce: 6,000, etc.

²⁵⁷ Manfred Burba, *Treblinka. Ein NS-Vernichtungslager im Rahmen der “Aktion Reinhard”*, Göttingen 1995, p. 18.

Warsaw:	254,000		
District Warsaw:	110,000	Slovakia:	7,000
District Radom:	364,000	Theresienstadt:	8,000
District Lublin	33,000	Greece:	14,000
District Białystok:	122,000	Total (other nations):	29,000
Poland total:	883,000		
SUM OF VICTIMS		ALL VICTIMS	
1942	837,000	912,000	
1943	75,000		

Burba's bar graph refers to the monthly number of victims. Though it contains no figures, these can be derived without difficulty from the bars, which reflect the numbers:

1942		1943	
July:	67,000	January:	28,000
August:	246,000	February:	14,000
September:	200,000	March:	14,000
October:	203,000	April:	7,000
November:	82,000	May:	3,500
December:	39,000	June/July:	0
		August:	8,500
TOTAL 1942:	837,000	TOTAL 1943:	75,000

Thus, according to M. Burba, 912,000 people were killed in Treblinka. Concerning his sources, the author writes:²⁵⁸

"The calculation of the number of victims is essentially based upon documents of the German Reichsbahn [German rail system] and upon surveys and censuses of the most diverse kind in the ghettos in occupied Poland as well as eyewitness narratives."

Yet, in reality, Burba's figures are based upon the previously mentioned lists of Arad, whose numbers (881,390) he raised to 883,000, adding to this 29,000 deportees from Slovakia, Theresienstadt, and Greece not mentioned by Arad.

The arbitrariness, with which such statistics are produced, is even more blatantly evident in the calculations of Ryszard Czarkowski, who devotes an entire chapter to them in his 1989 book on Treblinka. He divides the history of the camp into five periods:

- First Period: June 25 to July 23, 1942
- Second Period: July 23 to December 15, 1942
- Third Period: December 15, 1942, to January 9, 1943
- Fourth Period: January 15 to August 2, 1943
- Fifth Period: August 2 to August 23, 1943

²⁵⁸ *Ibid.*, p. 17.

For the first period, Czarkowski relies upon the testimony of Jan Sułkowski, according to whom the gas chambers of the first killing facilities were put into operation on June 25, 1942, and from then on one transport of Jews daily arrived at Treblinka. Czarkowski, accepting the figures given by Łukaszkiwicz (50 cars per train, 100 persons per car), for a period of 30 days (June 25 to July 23²⁵⁹) gets $(30 \times 50 \times 100 =)$ 150,000 people deported to Treblinka and murdered there, even before the camp was opened!

For the second period, Czarkowski arbitrarily assumes 125 days of operation and 2 transports per day, so that in this time span not fewer than $(125 \times 2 \times 50 \times 100 =)$ 1,250,000 people are to be recorded as having been deported and murdered!

The figure for the third period he calculates in the following fashion: according to an issue of the newspaper *Wiadomosc*, 120,000 Jews were sent to Treblinka from August 19, 1942, to January 9, 1943. Czarkowski divides this number by the number of days contained in the time span involved, multiplies the result by the number of days between December 15 and January 9 and rounds the product to 22,000, and in so doing shows no concern whatever about the fact that the information appearing in the newspaper boldly contradicts his assumption for the second time period: if, from July 23 to December 15, 1942, 1,250,000 Jews were really deported to Treblinka and 22,000 from December 15, 1942, to January 9, 1943, then, from August 19 to December 15, 1942 $(120,000 - 22,000 =)$ 98,000, and from July 23 to August 19, 1942, $(1,250,000 - 98,000 =)$ 1,152,000 Jews had to have been taken to Treblinka, which gives an average of 41,000 per day for the period just named!

For the fourth period Czarkowski accepts Łukaszkiwicz's hypothesis of one transport per week, but he arbitrarily lengthens the time period of deportations by 6.5 weeks and by means of this artifice using 26 weeks, gets $(26 \times 50 \times 100 =)$ 130,000 deportees.

For the fifth and final period, he adopts without reservation the 303 cars reckoned by Łukaszkiwicz; this corresponds to 30,300 deportees, which Czarkowski rounds to 30,000. Thus he comes up with $(150,000 + 1,250,000 + 22,000 + 30,000 =)$ 1,582,000 victims!²⁶⁰

To be sure, this result is clearly pure insanity, yet the method employed by Czarkowski is exactly the same as that used by the other authors previously cited, with the exception of Gilbert and Arad, who proceed more subtly in that – as demonstrated – they parcel out to a certain number of locations, according to utterly arbitrary criteria, a predetermined number of victims in order to create the illusion that the total number of those deported to Treblinka, along with their places of origin, is accurately known.

²⁵⁹ In actuality, this was 29 days, including June 25.

²⁶⁰ R. Czarkowski, *op. cit.* (note 75), pp. 189-202.

Even more remarkably, not one of these authors refers to the report made by the statistician Richard Korherr at the beginning of 1943 at the instruction of Heinrich Himmler, although very accurate numbers of the Jews deported to the supposed extermination camps are given in this. In his overview concerning the “*Evakuierung der Juden*” (evacuation of the Jews, part 4 of the fifth chapter of his report), Korherr wrote:²⁶¹

“ <i>Transportation of Jews from the Eastern provinces to the Russian east:</i>	1,449,692
<i>Processed through the camps in the General Gouvernement area:</i>	1,274,166
<i>through the camps in the Warthegau:</i>	145,302”

The camps considered to be located “in the General Gouvernement area” are Bełżec, Sobibór, and Treblinka; the camp in the Warthegau was Chełmno.²⁶² The number given, 1,274,166, is the very number of victims, according to this historiography, of the three camps in the General Gouvernement up to the end of 1942. If this had been true,²⁶³ the following would have been the result of this: since Bełżec, to which usually 600,000 victims are ascribed, was closed in December 1942,²⁶⁴ and since Herr Dr. Scheffler himself postulates for Sobibór 180,000 as the total number of victims for the whole year of 1942,²⁶⁵ then (1,274,166 - 600,000 - 180,000 =) approximately 494,000 people would have to have been killed in Treblinka in 1942, and with the addition of a maximum number of 75,000 for the following year of 1943, one would arrive at 569,000. How can Herr Dr. Scheffler, who assumes for Bełżec not the usual 600,000, but 800,000 victims,²⁶⁶ speak seriously of 900,000 Treblinka victims? According to his numbers, in the year 1942 a total of 1,880,000 people had to have been ‘gassed’ in the three camps of the General Gouvernement area, thus 600,000 more than were ‘processed’ according to the Korherr Report!

In this section we wish to demonstrate not so much the differences in the numerical data of the various authors as the incredible superficiality and illogic of their method. Since they are all speaking not just of deportees, but of people murdered – therefore of people supposed to have been killed by means of exactly described techniques – the shocking method of their calculations is coupled with an astonishing lack of critical intellect, often verging on stupidi-

²⁶¹ NO-5194, p. 9.

²⁶² The following is unclear in the Korherr Report: the sum of the two lower numbers is not 1,449,692, but 1,419,467, so that 30,225 persons are missing, and the category to which they belong is unknown.

²⁶³ Here we are discussing not the numbers given by Korherr, but their interpretation, *i.e.* the claim that the Jews in question were not ‘processed through’ the camps involved, but were ‘gassed.’

²⁶⁴ *Encyclopedia of the Holocaust, op. cit.* (note 18), Vol. I, p. 178.

²⁶⁵ A. Rückerl, *NS-Vernichtungslager...*, *op. cit.* (note 61), p. 151.

²⁶⁶ A. Rückerl, *NS-Prozesse, op. cit.* (note 250), p. 36.

ty, which is strikingly apparent in comparison with the two isolated representatives of official historiography who have brought at least a modicum of critical thinking to this field.

In 1953, Gerald Reitlinger was already writing:²⁶⁷

“It would in any case have been impossible to gas the greater part of the 310,000 Jews who were deported from Warsaw, together with an unknown proportion from other ghettos, in three gas chambers, each measuring fifteen feet square, in no more than seventy-five working days.”

Faced with salvaging what could be salvaged in light of this impossibility, he deduced:²⁶⁷

“Therefore a large proportion must have died in the trains.”

This is likewise an untenable claim: according to train schedule no. 548 of August 3, 1942, the trip from Warsaw to Treblinka lasted only 3 hours and 55 minutes,²⁶⁸ and even if the conditions in the overcrowded trains were execrable, under no circumstances could they have resulted in mass deaths among the occupants.

In an interview granted by Jean-Claude Pressac in 1995, published for the first time in 2000 with changes made according to his wishes, Jean-Claude Pressac proposed his own original statistics for the alleged victims of the eastern camps, in which he started from the basis of these camps’ attested capacity for extermination:²⁶⁹

“I have attempted to determine the number of victims of the camps designated as extermination camps on the basis of material facts: the surface area of the gas chambers and number of the persons which they could hold; time for a gassing; number of gassings daily; number of transports arriving daily with consideration of the actual capacity of the chambers, etc. In comparison with the numbers of Hilberg, which are based upon Polish sources, I arrive at the following figures:

<i>Chełmno:</i>	<i>80,000 to 85,000</i>	<i>instead of 150,000;</i>
<i>Belzec:</i>	<i>100,000 to 150,000</i>	<i>instead of 550,000;</i>
<i>Sobibor:</i>	<i>30,000 to 35,000</i>	<i>instead of 200,000;</i>
<i>Treblinka:</i>	<i>200,000 to 250,000</i>	<i>instead of 750,000;</i>
<i>Majdanek:</i>	<i>fewer than 100,000</i>	<i>instead of 360,000.”</i> ²⁷⁰

²⁶⁷ G. Reitlinger, *The Final Solution*, *op. cit.* (note 180), p. 149.

²⁶⁸ Reproduction of the document in: Raul Hilberg, *Sonderzüge nach Auschwitz*, Dumjahn, Munich 1981, p. 178.

²⁶⁹ “Entretien avec Jean-Claude Pressac réalisé par Valérie Igounet, à la Ville-du-bois, le jeudi 15 juin 1995,” in: V. Igounet, *op. cit.* (note 90), pp. 640f.

²⁷⁰ The number of 360,000 Majdanek victims is not postulated by Hilberg, but was accepted in Poland at the beginning of the 1990s as obligatory; meanwhile, the figure has been reduced by Polish historians first to 230,000, then to 78,000. Hilberg speaks of 50,000 Jewish victims of Majdanek (note 17); he does not deal with non-Jewish victims. Cf. in this regard J. Graf, C. Mattogno, *Concentration Camp Majdanek. A Historical and Technical Study*, reprint of 3rd ed., Castle Hill Publishers, Uckfield, 2016, Chapter 4 and Supplements.

If we take the lowest of his estimates, Pressac therefore reduces the total number of victims of these five ‘extermination camps’ (Auschwitz is not considered in the statistics) from 2,010,000 to 510,000. But the number given by him for Majdanek – the only one of these camps from which documentary data were obtained – is still more than double the actual number, for the documents reveal that in Majdanek about 42,300 (Jewish and non-Jewish) prisoners died.²⁷¹ One page later Pressac adds:

“Concerning the massacre of the Jews, several fundamental notions must be questioned. The numbers arrived at [by official historiography] are to be thoroughly revised. The expression ‘genocide’ is no longer suitable.”

Since Pressac does not rely upon documents, but merely upon the theoretical maximum capacity of extermination facilities, the existence of which remains unproven, his numbers are of course very contestable, but one thing is certain: whoever speaks of a mass extermination in Treblinka – to confine ourselves here to this camp – cannot blindly accept the monstrosities claimed by the witnesses and is not released from the duty of soberly taking into consideration what Pressac calls “material facts.” We shall return to this point in the following chapter.

Finally, the reader’s attention may be directed to one more grotesque statistical detail, which arises out of the claim that because of the overloading of the first ‘gas chamber’ building with only three killing chambers another large building with ten more chambers was constructed.²⁷²

According to the *Encyclopedia of the Holocaust*, construction on this new building was completed in October 1942.²⁷³ Consequently, we assume that this installation began operations in November 1942. According to the same *Encyclopedia*, the chambers in the old building had a total area of about ($3 \times 4 \text{ m}^2 =$) 48 m^2 , but the new ones had a total area of 320 m^2 . From November 1942, therefore, ($48 \text{ m}^2 + 320 \text{ m}^2 =$) 368 m^2 were available in the camp for mass killing. The ratio of the areas before and after November 1942 was thus $48 \text{ m}^2 \div 368 \text{ m}^2 = 1:7.67$.²⁷⁴

As already stated, according to Y. Arad, 694,000 people are supposed to have been murdered in Treblinka up to the end of October 1942, but after that ‘only’ 187,390 more.²⁵³ The ratio of the killings in the time intervals up to the end of October 1942 and after that is therefore 1:0.27. If one assumes that the original three small ‘gas chambers’ were used at 100% of their capacity up to the end of October 1942 – otherwise there would have been no reason to build the new, larger building – for the thirteen gas chambers which were available

²⁷¹ J. Graf, C. Mattogno, *ibid*.

²⁷² This section is from the publisher G. Rudolf.

²⁷³ *Encyclopedia of the Holocaust*, op. cit. (note 18), p. 1485.

²⁷⁴ During the Düsseldorf Treblinka Trial, to be sure, other measurements were given for the chambers (16 m^2 old, 32 m^2 new), whose surface proportions, however, were roughly the same, cf. pp. 145f. in this book.

from November 1942, there was a utilization factor of only $(0.27 \div 7.67 =)$ 3.5%!

The question that occurs in light of this statistical fact is obvious: Why are the ten new, larger 'gas chambers' supposed to have been built, if afterwards they were not needed at all? The grotesque contradiction between mass killings claimed for the respective time periods and the massive expansion of extermination capacity maintained by the witnesses is strong evidence that the latter claim is based not upon facts but rather has an origin in propaganda: three 'gas chambers' were simply not monstrous enough. The demonic nature of the German had to be undergirded with ever escalating 'facts.'

TIME SPAN	# OF CHAMBERS	AREA	NUMBER MURDERED	UTILIZATION CLAIMED
Until the end of October '42	3	48 m ²	694,000	100%
From November 1942	10+3	368 m ²	187,390	3.5%

Chapter IV: The Alleged Extermination Facilities in Treblinka: An Historical and Technical Analysis

1. Planning and Construction of the Eastern 'Extermination Camps'

The planning and construction of the so-called 'extermination camps' Treblinka, Sobibór, and Bełżec, as reconstructed by the official historiography, raises serious problems, which have remained unsolved to the present. The chief problem consists in the absence of rational planning and in the unbelievably primitive architectural and technical structure of these camps, which stands in the strongest contrast to that of the others, especially of the so-called 'extermination camp' Auschwitz. Raul Hilberg is one of the very few representatives of the orthodox historiography who have brought up the problem and sought to solve it. He explains:²⁷⁵

"Why three camps and not one? Why were they built one after the other, first Bełżec, then Sobibor, and lastly Treblinka? Why in the beginning in each camp only three gas chambers, if they did not then suffice? One could be inclined to answer that the planners did not know the entire extent of their task, that they were groping their way toward the goal without having it in sight. That is not totally unimaginable, but it is certainly not the whole explanation and perhaps not even the most important. It was a matter of, in short, a difficult administrative problem.

The Third Reich had neither a particular central authority nor its own budgetary title for a 'Final Solution to the Jewish Problem.' The construction of the camps, the positions for guard staff, and the management of transports all had to be financed in a complex manner. Auschwitz II and Lublin, for example, were designated in the beginning as camps for prisoners of war of the SS, and indeed not only for camouflage but for budgetary reasons. Bełżec, Sobibor, and Treblinka, on the other hand, were plain and simple killing camps. But they could not be operated that way under any

²⁷⁵ Raul Hilberg, "Die Aktion Reinhard," in: Eberhard Jäckel, Jürgen Rohwer (eds.), *Der Mord an den Juden im Zweiten Weltkrieg*, Deutsche Verlags-Anstalt, Stuttgart 1985, pp. 129f.

economic role, and there is much to show that the means for their construction and operation were fragmentary and minimal. That is probably the reason why they did not grow into a fully developed building complex. They probably had to be built in sequence and step by step, in order to remain financially inconspicuous.”

These theses, proposed by a scholar who devoted his *magnum opus*²⁷⁶ largely to an exposition of the bureaucratic-administrative structure of the Third Reich, are quite simply absurd.

No one who knows the complex structure and manner of functioning of the National Socialist economic-administrative offices²⁷⁷ can seriously believe that camps of any sort whatever would have been able to originate and develop in the General Gouvernement without precise planning and a specific budget.

Insofar as construction was concerned, the General Governor of occupied Poland was, via several intermediates, ultimately subject to *Reichsminister* Albert Speer, who was the German plenipotentiary for the regulation of all construction. Speer instructed his local deputy, the SS Administrator at the office of the *Höherer SS- und Polizeiführer* (Senior SS and Police Chief) in the General Gouvernement, who, in turn, instructed the plenipotentiary for the regulation of all constructions in the General Gouvernement.²⁷⁸

The SS Administrators appointed to each Senior SS and Police Chief (HSSPF)²⁷⁹ were responsible “for administration of all economic affairs of the SS departments and SS units in the sphere of their respective HSSPF”, and indeed specifically “for budgetary, treasury, and accountancy, legal affairs [such as leases, insurance, and the like], preliminary examination, financial commitments, engine transport, management of raw materials, building, economic undertakings, and concentration camps.”²⁸⁰

In practice, the SS Administrator represented simultaneously *Reichsminister* Speer and the *SS-Wirtschafts-Verwaltungshauptamt* (WVHA, Economic

²⁷⁶ R. Hilberg, *op. cit.* (note 17). Hilberg deals with the core of the ‘Holocaust’ theme, the process of extermination in the death camps, on all of 19 pages of the 1300 pages of his three-volume work! Cf. regarding this Jürgen Graf, *The Giant with Feet of Clay*, 2nd ed., Castle Hill Publishers, Uckfield 2015.

²⁷⁷ On this cf. Carlo Mattogno, *The Central Construction Office of the Waffen-SS and Police Auschwitz: Organization, Responsibilities, Activities*, 2nd ed., Castle Hill Publishers, Uckfield 2015.

²⁷⁸ WAPL, 268, pp. 81f.

²⁷⁹ The HSSPF were those from *Ostland*, Central Russia, Russia-South and North as well as Serbia. *Ostland* was the war-time term for the northeastern territories of the USSR occupied by German forces, running north of the Ukraine up to the Baltic Sea and included what is now Belarus (White Russia), Estonia, Latvia, and Lithuania and parts of Russia itself.

²⁸⁰ Hans Buchheim, “Die SS – das Herrschaftsinstrument”, in: Hans Buchheim, Martin Broszat, Hans-Adolf Jacobsen, Helmut Krausnick, *Anatomie des SS-Staates*, DTV, Munich 1982, Vol. 1, p. 139; Engl.: *Anatomy of the SS State*, Collins, London 1968.

Administrative Main Office). In accord with the structure of this office, the scope of the work of the SS Administrator was subdivided into five groups, of which Group C – Construction bore the responsibility for construction.

Finally, four SS and Police Chiefs, one for each district: Warsaw (Arpad Wigand), Lublin (Odilo Globocnik), Radom (Carl-Albrecht Oberg), and Lemberg (Fritz Katzmann) were under the Senior SS and Police Chief in the General Gouvernement.

In November 1941, Amt II “*Bauten*” (Bureau II “Buildings”) of the *Hauptamt Haushalt und Bauten* (HHB, Main Office Budget and Buildings) encompassed seven construction inspection units of the Waffen-SS and Police with the Senior SS and Police Chiefs. The jurisdiction over the General Gouvernement, upon whose territory the camps of Bełżec, Sobibór, and Treblinka were situated, was exercised by the *Bauinspektion der Waffen-SS und Polizei Reich Generalgouvernement* (Construction Inspection of the Waffen-SS and Police Reich General Gouvernement), which was composed of five *Zentralbauleitungen* (Central Construction Offices) with nine Construction Offices of the Waffen-SS and Police. The Construction Inspection Office had its seat in Krakow, while the Central Construction Offices were located in Krakow, Warsaw, Lublin, Dębica, and Lemberg (the last belonged administratively to the General Gouvernement).²⁸¹ The Central Construction Office of the Waffen-SS and Police at Warsaw was thus subject to both the Construction Inspection Office of the Waffen-SS and Police Reich General Gouvernement and also to the SS Administrator at the Senior SS and Police Chief in the General Gouvernement.

All construction work carried out in the General Gouvernement in the year 1942 followed normal bureaucratic practice, which appears to be as follows: instructions from the Department Group C “Constructions” of the SS WVHA, in correspondence with the directives of *Reichsminister* Speer, went through the SS Administrator to the Central Construction Offices and Construction Units, which were in charge with accomplishing the actual constructions.

Insofar as Treblinka was concerned, this practice is fully confirmed by the single known document dealing with the construction of the camp. It is a work certificate for June 1, 1942, about which the Polish judge Z. Łukaszkiewicz reports the following:²⁸²

“The witness Lucjan Puchala, railway technician, has produced a very interesting document: a certification to begin work from the Central Construction Office of the Waffen-SS and Police, issued on June 1, 1942. According to the information in it, on this day the construction of a spur line, which was supposed to lead from the branch line to the camp, was delegat-

²⁸¹ WAPL, 3, pp. 12, 24.

²⁸² USSR-344. GARF, 7445-2-126, p. 320 (p. 3 of the report).

ed to him. This certificate is valid until the 15th of June 1942,^[283] and on this day the construction ended, according to the statement of the witness.” Łukaszkiwicz later completely transcribed the document involved. Its text reads as follows:²⁸⁴

*“Central Construction Office of the Waffen-SS and Police, Warsaw.
Warsaw, June 1, 1942, Koszykowa 8, Post Office Box 214
Tel. 9-21-83*

Certificate No. 684

The Pole Lucjan Puchala, born on ..., is employed as technician at the local administrative office of Koszykowa. It is requested that the said person be allowed to pass unhindered and that he not be called in for other work. This certificate is valid until the 15th of June 1942 and can be extended only by the local administrative office. The card is to be voluntarily returned on its expiration day.

Director of the Central Construction Office.

(Signature illegible) SS-Scharführer.”

This document proves that the Central Construction Office of the Waffen-SS and Police at Warsaw was responsible for the construction of the Treblinka Camp and thus was following common practice. According to Arad, two German firms had contracts for the establishment of the camp: Schönbronn in Leipzig and Schmidt-Münstermann.²⁸⁵ These firms – besides them, still others doubtlessly participated in the construction – received their commissions from the Central Construction Office of the Waffen-SS and Police at Warsaw, just as did Lucjan Puchala. Thus, this office functioned as principal, and all the norms, including financial, that applied in the intercourse between the Central Construction Office and the civilian firms acting on its commission, were in force here as well. Surely the accounting department of the construction inspection unit of the Waffen-SS and Police Reich General Gouvernement regulated the latter, just as the accounting office of the construction inspection unit of the Waffen-SS and Police of *Reich-‘Ost’* (east) was responsible for Auschwitz.²⁸⁶ This means that Treblinka (and, logically, also Bełżec and Sobibór) must have been specifically budgeted for, and that the camp came into being on the basis of a precise plan.

This applies also to the labor camp Treblinka I. Viewed politically and administratively, the labor camp Treblinka I was subordinate to the SS and Police Chief in the Warsaw district, Arpad Wiegand, who had been assigned to construct this camp. This is clear from three documents concerning the delivery of various materials – pipes, nails etc. – for the camp Treblinka I.

²⁸³ In the text “1945” appears by error.

²⁸⁴ Z. Łukaszkiwicz, *Obóz straceń w Treblince*, *op. cit.* (note 38), p. 51.

²⁸⁵ Y. Arad, *op. cit.* (note 71), p. 37; Arad gives no sources for his information.

²⁸⁶ For this, see Carlo Mattogno, *op. cit.* (note 277), pp. 43-45.

The first of these three documents is a letter dated June 19, 1942, by the *SS Unterscharführer* (sergeant) Dr. Irmfried Eberl at the office of the SS and Police Chief in the Warsaw district. The letter is addressed to the Commissioner for the Jewish residential district and begins with the sentence:²⁸⁷

“For the Treblinka Camp the following are still required [...].”

The second of these documents is a letter whose date is illegible, but which probably likewise falls in June of 1942. It was sent by Heinz Auerswald, commissioner for the Jewish residential district in the office of the Governor of the Warsaw district, “to the Chairman of the Jewish Council of Warsaw” and begins as follows:²⁸⁸

“The following objects are required for the construction of the Treblinka Camp [...].”

The third of these documents, a letter of June 26, 1942, from Dr. Eberl to the commissioner for the Jewish residential district, Auerswald, on the subject “Work Camp Treblinka”, reads at the beginning:²⁸⁹

“For the construction of the labor camp Treblinka the following objects are urgently required [...].”

The “labor camp Treblinka” was established by ordinance of the Governor of the Warsaw district of November 15, 1941. The order to construct the camp, in which its purpose is also stated, was published on December 16, 1941, in the *Amtsblatt für den Distrikt Warschau Generalgouvernement* (Official Gazette for the Warsaw district of the General Gouvernement) No. 11-12 on p. 116.²⁹⁰

The mining of gravel from the pits at Treblinka I was directed by the “*SS-Sonderkommando Treblinka*” (SS Special Command Treblinka),²⁹¹ which according to Łukaszkiwicz was the official designation of the alleged ‘Death Camp’ (therefore of Treblinka II).²⁹² This is confirmed by the fact that the mining of gravel was an operation conducted on the site by a corresponding firm, namely the Deutsche Herd- und Steinwerk GmbH Kieswerk Treblinka (German Hearth- and Masonry Works, Inc., Gravel Works Treblinka).²⁹³

Thus the “*Sonderkommando Treblinka*” had a perfectly institutional identity and consequently was a component of the administrative structure of the General Gouvernement. Politically, it was subordinate to the SS and Police Chief in the Warsaw district and to the Senior SS and Police Chief in the Gen-

²⁸⁷ Document reproduced in Stanisław Wojtczak, *op. cit.* (note 60), p. 167.

²⁸⁸ *Ibid.*, p. 168.

²⁸⁹ Document reproduced in *Faschismus – Getto – Massenmord. Dokumentation über Ausrottung und Widerstand der Juden in Polen während des zweiten Weltkriegs*, Röderberg Verlag, Frankfurt/Main 1960, p. 304.

²⁹⁰ Document reproduced in S. Wojtczak, *op. cit.* (note 60), pp. 155f.

²⁹¹ See Document 16 in Appendix.

²⁹² USSR-344. GARF, 7445-2-126, p. 319 a (p. 2 of the report).

²⁹³ See Document 17 in the Appendix.

eral Gouvernement (Friedrich Wilhelm Krüger), administratively to the Central Construction Office of the Waffen-SS and Police at Warsaw as well as to the SS Administrator.

In short: the claim according to which the camps Treblinka, Bełżec, and Sobibór are supposed to have been constructed without any sort of budgetary entries is historically false and plainly absurd to anyone familiar with the bureaucratic conventions of the Third Reich.

How is the rather rudimentary character of these camps to be explained? In reality, this question is incorrectly formulated, for the primitiveness of the three camps is not supported by any kind of documentation, but merely from witness statements. We have learned abundantly from the preceding chapters what sort of value ought to be attached to these. Thus, the primitive character of the camps is no objectively proven fact, but simply a subjective reconstruction. On the contrary: since the camps were constructed in conformity with the usual economic and administrative standards, as applied to the other camps as well, they could not have been primitive in any way, and one comes inevitably to the conclusion that the subjective reconstructions based upon testimonies of witnesses cannot reflect the reality.

In these unreal reconstructions of Treblinka, the unspeakably primitive character of the *crucially important* buildings, for which the camps are alleged to have been built – namely the killing and corpse cremation facilities – is glaringly obvious. We begin with the killing installations, and we will confine ourselves strictly to Treblinka.

2. The Alleged Killing Installations in Treblinka

In the following, we will dispense with any discussion of the many technical fantasies, like the steam and vacuum chambers, described by many witnesses. We confine ourselves to those extermination techniques which, according to today's official historiography, are supposed to have been employed in Treblinka. As the starting point for this, we choose the verdict of the Court of Assizes of Düsseldorf²⁹⁴ of September 3, 1965, against Kurt Franz:²⁹⁵

“The gas chambers, in which the Jews were killed by means of exhaust fumes of a diesel engine, formed the center of the death camp. At the beginning of the mass killings there was only the so-called ‘old gas house.’ The building, solidly constructed out of brick upon a concrete foundation, contained 3 gas chambers, which were approximately 4 × 4 m in area and about 2.6 m high, as well as a machine room for the diesel engine and the lighting plant of the camp. All of the rooms were situated on a wooden cor-

²⁹⁴ See Chapter V on this.

²⁹⁵ A. Rückerl, *NS-Vernichtungslager...*, *op. cit.* (note 61), pp. 203f., 224, 226.

ridor which was built out from the masonry structure and which one reached by climbing several steps. From this corridor, doors led into the gas chambers. These doors were about 1.80 m in height and 90 cm wide and were made somewhat in the way that air-raid doors are, so that they sealed off the chambers nearly airtight. Across from these, on the exterior wall in each gas chamber, were flap doors made from thick wooden planks. These were approximately 2.50 m wide and about 1.80 meters high and could be tilted upwards when opened in the manner of modern garage doors. They led to a wide concrete ramp, situated about 0.70 m above the level of the ground, which ran around the entire building. The floor of the gas chambers was tiled and was tilted toward the ramp. The walls were likewise tiled, at least to a certain height. On the ceiling of the individual chambers there were several pipes and showerheads. Due to this, the gas chambers were supposed to evoke the impression of shower rooms. However, the piping really served for the introduction of exhaust gases produced by the diesel engine in the machine room. There was no special lighting installation in the chambers.

Very soon after the inception of operations, the capacity of the old gas house proved to be insufficient for smoothly liquidating the daily arriving transports of Jews. For that reason, at the end of August/beginning of September 1942, the construction of a new large gas house was started, which contained more and larger gas chambers and was able to be put in operation after a construction period of about one month.

This building, which was built between the junction of the hose [=Schlauch, a nickname for the path to alleged “gas houses”—ed.] and the old gas house, was also solidly built out of brick on a concrete foundation. Five wide stone steps, decorated with flower bowls at the sides, led to the entrance at the front of the building and opened into a wide corridor, on both of whose sides lay the new gas chambers. Their exact measurements cannot be determined, since neither the defendant L. nor his co-defendants nor even the Jewish witnesses can give precise details about this. All are merely in agreement that the new gas chambers had a holding capacity approximately double that of the chambers in the old building. The new gas chambers were probably about 8 m long, 4 m wide, and 2 m high. [...] The process of extermination itself lasted approximately 30 to 40 minutes. [...]

An accepted holding capacity of approximately 200 to 350 people per gas chamber in the old house and approximately 400 to 700 people per gas chamber in the new house might safely be said to be most probable according to all [information].”

This description basically corresponds to that given by Łukaszkievicz, based upon the witness testimonies of Wiernik, Reichmann, Czechowicz, and Finkelsztejn:

“Both structures were built according to the corridor system, in which the entrance to the chambers in the 1st building was on both sides of the corridor, while in the small building the entry to the chambers was only on one side. The entrance was relatively small and closed with exactly fitting doors. On the exterior wall of the chamber was a large flap, which opened upward and which served for removal of bodies. The chambers were tiled; the floor sloped toward the exterior, which facilitated the removal of bodies. In the ceiling there were openings for the exhaust pipes of the engines that were located in annexes. These openings served to supply the exhaust gas, from which the victims suffocated. Witness Wiernik, who was employed as a master carpenter during all of his stay at the camp and had relative freedom of movement, gives the following dimensions of the chamber: in the small building 5 × 5 m, in the large 7 × 7 m.”²⁹⁶

The data given by the official historiography is, in reality, based almost entirely upon the witness testimony of Jankiel Wiernik, who for his part, as we explained in the second chapter, appropriated his description of the steam chambers from the report of November 15, 1942.

But even with respect to the structure, indeed, even with respect to the number of the alleged gas chambers of the second installation – likewise based upon witness statements – there are variations, which receive no mention whatsoever in the official historiography.

In Chapter III we cited the witness testimony of Abe Kon, according to whom the second killing facility contained 12 gas chambers. The Soviet report on Treblinka of August 24, 1944, in which 12 gas chambers are correspondingly mentioned, is based upon this testimony.²⁹⁷ As already seen, the current official version speaks of 10 chambers. The witnesses Willi Metz and Otto Horn, who had worked in ‘Camp II’, declared that the installation had 6 gas chambers.²⁹⁸ Jankiel Wiernik wrote that at his arrival in Treblinka there had been three gas chambers and that two more were added during his stay in the camp even before the construction of the second extermination facility,²⁹⁹ so that there were 15 and not 13 gas chambers in total.

According to the witnesses cited by W. Grossmann, the gas chambers in the second facility measured 7 m × 8 m,³⁰⁰ according to the witnesses questioned by Łukaszkiwicz, 7 m × 7 m,³⁰¹ according to the witness Abe Kon, 6

²⁹⁶ USSR-344. GARF, 7445-2-126, p. 321 (p. 5 of the report).

²⁹⁷ See Chapter III, Section 1.

²⁹⁸ Michael Tregenza, “Christian Wirth. Inspekteur der SS-Sonderkommandos “Aktion Reinhard” in: *Zeszyty Majdanka* (Majdanek Notebooks), Vol. XV, 1993, p. 11.

²⁹⁹ See Chapter II, Section 5.

³⁰⁰ V. Grossmann, *Treblinski Ad*, op. cit. (note 23), p. 186; V. Grossmann: *Die Hölle von Treblinka*, op. cit. (note 26), pp. 47f.

³⁰¹ USSR-344. GARF, 7445-2-126, p. 321 (p. 5 of the report).

m × 6 m,³⁰² and according to the version accepted today, 8 m × 4 m. The maximum capacity of these chambers varies between 600 (Abe Kon) and 1,000 to 1,200 (Jankiel Wiernik).³⁰³ Last, Elias Rosenberg claims that the second killing facility was not constructed between August and October 1942, but rather in March of 1943.³⁰⁴

The witnesses also disagree about the location of the small observation windows in the gas chambers. In the front-line report of TASS of September 11, 1944, it says:³⁰⁵

“The people in the ‘bath’ died under horrible tortures after ten minutes. The ‘bath-master’ recorded this by means of a small glass window in the door.”

On the other hand, the Polish-Soviet protocol of September 15, 1944, asserted:³⁰⁶

“On the roof of this – hermetically sealable – building was a small window, through which the death struggle of the dying could be observed.”

E. Rosenberg also claims that this little window was located on the roof of the gas chambers.³⁰⁷

At the same time, the military examining judge of the military administration of the 65th Soviet Army, First Lieutenant of Justice Jurowski, was drawing plans of the first as well as the second alleged killing facilities of Treblinka. The first bears the inscription “Plan of the Building No. 1 of the Treblinka Camp 2, in which the killing of people of Jewish nationality occurred.”³⁰⁸ The drawing is furnished with numbers from one to seven and further with the Cyrillic letters ‘а’, ‘б’, ‘в’.

According to the key of the illustration, the figures and letters show the following facilities:

- 1: Annex
- 2: Room in which the engine was located
- 3, 4, 5: Chambers
- 6: Room for employees
- 7: Ramp
- a: Pipeline from engine
- б: Window (= opening) through which gas was drawn off to the roof
- в: Door

In addition, there is a note without number or letter on the drawing: “Gas pipe into the chambers.”

³⁰² See Chapter II, 1.

³⁰³ J. Wiernik, in A. Donat, *op. cit.* (note 4), p. 161.

³⁰⁴ E. Rosenberg, *op. cit.* (note 187), p. 139 (p. 7 of the report).

³⁰⁵ GARF, 7021-115-8, p. 218.

³⁰⁶ GARF, 7021-115-11, p. 44.

³⁰⁷ See below, Section 8.

³⁰⁸ See Document 18 in the Appendix.

There is a drawing of a small tractor in Room 2. The measurements for Room 3 are also entered – $m\ 4 \times 5$ – which are the same for Room 1 and 2. The annex (пристройка=pristroika) is almost certainly a corridor, which one can enter by a two-step stairs (toward the left of the drawing); the ramp can also be reached from both sides by way of two steps. The ‘windows’ on the ceiling measure approximately $0.5\ m \times 0.5\ m$ according to the plan, and are supplied with grates.

The second drawing bears the description “Plan of Building No. 2 of the Treblinka Camp, in which the killing of people of Jewish nationality occurred.”³⁰⁹

The picture legend furnishes the following designations:

- 1-10: Chambers
- 11: Corridor
- 12: Place where the engine was installed
- a: Introduction of the gas
- б: Removal of the gas from the chamber
- в: Door

A note without number or letter also appears in this drawing: “Pipe which led from the engine to the chambers.” A small tractor is here likewise drawn in Room 12.

These two drawings without a doubt depict two facilities with gas chambers, which are fed by engine exhaust gases (or, to put it more accurately, by the exhaust gases from a tractor). But none of the witnesses questioned by Judge Jurowski mentioned such a version of killing. As we pointed out in Chapter II, they did speak of an engine, but this served merely to operate the pump, by which the air was said to have been sucked out of the chambers, rather than for filling the chambers with exhaust fumes. This vacuum version was then officially voiced in the Soviet report on Treblinka of August 24, 1944, as well as in the Polish-Soviet protocol of September 15, 1944. What, therefore, was Judge Jurowski’s source?

The answer is simple: Jankiel Wiernik’s statements of May 1944, because the Soviet investigating judges were in possession of a copy of his text, which is explicitly mentioned in the Soviet report of August 24, 1944. As will be recalled, Wiernik had simply transformed the steam chambers of the report of November 15, 1942, into engine exhaust gas chambers, and even copied the drawing of the camp enclosed with that report. On this plan³¹⁰ the two alleged killing installations are drawn in, the first with three and the second with ten chambers, whose structure is practically identical with those of the two drawings of Judge Jurowski. But because Wiernik had forgotten to add to the ten gas chambers of his second drawing an eleventh room, in which the engine

³⁰⁹ See Document 19 in the Appendix.

³¹⁰ See Document 4 in the Appendix.

was installed, Judge Jurowski felt himself constrained to draw in the tractor (engine) at the end of the corridor, between chambers 5 and 10. He painstakingly adopted Wiernik's drawings, yet nonetheless attempted to bring a minimum of order to them and in doing so drew equipment within the installations, which Wiernik had not mentioned. Since the Soviet judge understood significantly more about engineering than the witness, he enhanced the drawing with another element, which would have been indispensable for a hypothetical mass killing with engine exhaust fumes, but of whose necessity Wiernik had not been aware: the openings for the removal of the gas, *i.e.* of the air-gas mixture. We will come back to this important point in Section 8.

It is clear from all this that Judge Jurowski was technically too well-versed to swallow the nonsense reported by the witnesses, but as Soviet military judge he accepted the story of the mass extermination in engine exhaust gas chambers and imbued it with a certain degree of plausibility by virtue of his drawings.³¹¹

3. Diesel Engine or Gasoline Engine?

In his excellent study *The Diesel Gas Chambers: Ideal for Torture – Absurd for Murder*,⁹⁸ Friedrich P. Berg investigated the present version of the mass murder in the alleged eastern extermination camps – gassing by means of diesel engine exhaust gases – from a technical standpoint. He particularly emphasizes that according to the laws of toxicology, a person who is exposed to a concentration of 0.4% carbon monoxide (CO) (*i.e.* 4,000 parts CO per million parts of air), dies in less than one hour. Since the time, in which death occurs, is directly proportional to the percentage of CO, it requires a concentration at least twice as high, thus 0.8%, in order to bring about death within half an hour or less. Of the two main types of diesel engines, which existed in the forties, Berg examines the one whose exhaust gases contain a larger percentage of CO, that is, the engine with an undivided combustion chamber. While running at idle, this engine produces about 0.03% CO, but under full load approximately 0.4%. Berg says in this regard:³¹²

“In other words, here we have a Diesel which looks as if it could have been used to commit mass murder in half an hour.”

But a diesel engine cannot continually run at full load, since it would soon break down due to the accumulation of solid compounds on the cylinder walls. On the other hand, a diesel normally operates with a large air surplus. At idle, with an air-fuel ratio of 100:1, the engine emits 18% oxygen, which is only

³¹¹ At this point in time, all references were to an “engine”; the version of a diesel engine had not yet triumphed.

³¹² Friedrich P. Berg, *op. cit.* (note 98), p. 447.

slightly less than the oxygen content of the air (21%) and suffices for survival. During a homicidal gassing, the oxygen content of the air must be so low that the victims suffocate from lack of oxygen, *i.e.*, at a level of approximately 9%. This is attained by producing an air-fuel ratio of 25:1, which is reached at about $\frac{3}{4}$ of full load.

According to the witnesses, the diesel engine of a Russian armored tank was employed at the gas chambers of Bełżec, Sobibór, and Treblinka. The strongest Soviet tank engine was found in the tank type T34: a V12-cylinder diesel with undivided combustion chamber, a maximum performance of 550 HP, a total cylinder volume of $38,860 \text{ cm}^3 = 38.86 \text{ liters}$, and a maximum of 1,900 revolutions per minute.

If the second gassing installation of Treblinka measured a total of 640 m^3 and was able to accommodate 3,200 people, Berg concludes from his calculations that the effective volume of air contained in it amounted to 400 m^3 , if assuming a body volume of 75 liters per person.

If one rounds the maximum number of revolutions per minute to 2,000, since a four-stroke engine empties its piston chamber only every second revolution, it emitted ($1,000 \times 38.86 =$) 38,860 liters or 38.86 m^3 of exhaust gases in one minute. Thus, the engine would have exchanged the entire content of air of the gas chambers in ($400 \div 38.86 =$) in something under 10 minutes. The gas chambers had to have openings for the removal of the air-gas mixture; otherwise they would have collapsed from the increased pressure. Berg begins by assuming that it requires 20 minutes under these circumstances until roughly the same percentage of CO is reached in the gas chambers as in the exhaust gases themselves, *i.e.*, realistically, 0.22 vol.% at full load and an air-fuel ratio of 20:1.

As Berg stresses, experiments with guinea-pigs showed the following:³¹³

“In the animal experiment previously described with a real CO concentration of 0.22%/vol., which was already established before the test animals were even introduced and which, because of the reduced oxygen content of 11.4%/vol., corresponded to an effective CO concentration of ($0.22 \times 21 \div 11.4 =$) 0.4%/vol., it still took more than three hours to kill all of the test animals. It is, therefore, perfectly reasonable and even quite conservative to say that in a similar gassing attempt with humans and with only a gradually increasing CO concentration, the majority of people in the alleged gas chamber would still be alive after one or even two hours. Such a result would have been an utter fiasco.”

Had the SS men wished to carry out mass gasings with engine exhaust gases, Berg argues, they would surely have resorted to a gasoline engine, the exhaust gases of which normally contain 7% by volume of carbon monoxide and 1% by volume of oxygen. With proper adjustment of the carburetor, the carbon

³¹³ *Ibid.*, p. 458.

monoxide content can be increased up to 12%. But that would have by no means been the ‘best’ source of CO available during World War II: due to a lack of gasoline, the German government passed laws that made it compulsory to equip all diesel-driven vehicles with producer gas generators, which generate a gas with up to 35% of CO from wood or coke. Hundreds of thousands of these truly poisonous generators operated in wartime Germany and in the occupied territories, and this technology was well-known to all major German politicians at that time, as Berg shows. Berg’s conclusion is thus more than justified:³¹⁴

“How absurd to believe anyone with even a minimum of technical understanding would even try to use the exhaust from [diesel engines] for murder, when the [producer gas] fuel itself was a thousand times more lethal!”

The next question is, whether the Germans in 1941 would have known that a gasoline engine would have been far more efficient for the mass killing of human beings in gas chambers. The answer is unequivocally yes. We present a single example.

In 1930, the Reich Office of Health and the company I.G. Farbenindustrie joined forces to perform a series of toxicological and hygienic experiments with combustion products of engines. E. Keeser, Professor and Doctor of Medicine; V. Froboese, Ph.D.; and R. Turnau, Ph.D., from the Reich Office of Health, participated in the research project, as did representatives from the I.G. Farbenindustrie of Oppau and Ludwigshafen; E. Gross, Professor and M.D.; E. Kuss, Ph.D.; G. Ritter, Ph.D.; and Professor W. Wilke, with a doctorate in engineering. The result of the study was published as a monograph under the title *Toxikologie und Hygiene des Kraftfahrwesens*.³¹⁵

The experiments were performed exclusively with gasoline engines because their exhaust gases were regarded as far more harmful than those of diesel engines. First, the scientists conducted preliminary experiments with three different engine types: Hanomag 2/10 HP, Adler 6/25 HP, and Benz 10/30 HP. The average composition of the exhaust gases was as follows:³¹⁶

Conditions	Engine	Carbon	Carbon	Oxygen	Hydrogen	Methane
		Dioxide	Monoxide			
		[% CO ₂]	[% CO]	[% O ₂]	[% H ₂]	[% CH ₄]
Idle [1,000 RPM]	Hanomag	7.7	5.2	1.6	-	-
	Adler	8.5	8.5	1.1	3.7	1.0
	Benz	9.2	6.3	1.0	3.4	0.1
Full Load [1,500 RPM]	Hanomag	3.2	0.2	1.4	-	-
	Adler	13.3	0.2	2.3	0.1	0.1
	Benz	13.5	1.7	1.1	0.5	0.1

³¹⁴ *Ibid.*, p. 464.

³¹⁵ *Toxikologie und Hygiene des Kraftfahrwesens*, Julius Springer Verlag, Berlin 1930.

³¹⁶ *Ibid.*, p. 4.

In subsequent experiments, the researchers chose the Adler engine. Regarding the working conditions of this engine they remarked:³¹⁷

“A special throttle device was attached to the air supply line of the carburetor, which permitted modifying the amount of fresh air sucked in by the machine within certain limits. By means of reducing the air supply, a rise in the content of unburned substance, and thus of the CO content in the exhaust gas, could be achieved, while just the opposite, a reduction of CO content, resulted from an increased air supply.”

After an analysis of six different kinds of gasoline, the scientists performed twelve main experiments. With respect to the emission of CO, the highest values were recorded at idle:³¹⁸

ANALYSIS OF GAS IN DIFFERENT EXPERIMENTAL SERIES³¹⁹

CO ₂ %	O ₂ %	CO %	H ₂ %	CH ₄ %	N ₂ %
8.20	1.12	9.08	4.70	0.60	76.28
8.20	2.07	8.30	5.37	0.23	75.63
9.10	0.73	8.55	2.61	2.10	76.98
9.10	0.89	7.64	3.32	0.53	78.15
8.90	1.35	8.06	3.99	0.17	77.54
8.90	1.24	8.10	4.33	0.22	77.16
7.50	1.35	10.01	4.42	1.36	75.36
7.50	1.99	8.08	4.48	0.18	77.40
8.80	1.05	8.00	3.85	0.82	77.49
8.80	1.03	8.17	3.64	0.28	77.78
9.90	2.70	7.40	2.50	0.26	77.30
9.90	3.47	7.95	2.14	0.11	76.27

The technique employed in conducting the experiments was very advanced for that time.³²⁰ The researchers were carrying out toxicological tests, in which they constructed sophisticated miniature gas chambers. In particular, they performed preliminary tests, about which they wrote:³²¹

“The tests show that neither guinea pigs nor white mice showed severe symptoms of poisoning during a test duration of two hours with a CO concentration of 0.3%, but that any increase of the CO content beyond 0.3% led to seizure attacks, ataxia or narcosis, and that from these symptoms the increase of CO concentration in the air could be determined.”

The actual experiments were conducted with five types of gasoline and lasted 120 minutes each. White mice and guinea pigs served as experimental animals. The researchers explained:

³¹⁷ *Ibid.*, p. 5.

³¹⁸ *Ibid.*, Table I, p. 26.

³¹⁹ Chart is a slightly simplified representation.

³²⁰ See Document 20 in the Appendix.

³²¹ *Toxikologie und Hygiene des Kraftfahrwesens, op. cit.* (note 315), p. 45.

“After the first analysis data from the Orsat exhaust gas analyses^[322] had been obtained, the air supply of the carburetor was restricted to the point where the CO content of the exhaust gases climbed to 6.7%.”

Thus the experiments began with an air/exhaust gas mixture with a CO content of 0.3%. In these experiments, which lasted 120 minutes, ataxia and narcosis appeared in the guinea pigs, but none died.³²³

This study, the findings of which we have severely condensed, has an impressive bibliography of no less than 240 expert papers.³²⁴ It is now easy to conclude that the story of the diesel engine exhaust gas chambers is not only incredible, but borders on the absurd: whoever seriously defends it is like someone who wishes to claim that during the Second World War the Reich government preferred fighting with stone age weapons, although it had at its disposal a broadly diversified arsenal of the most modern weapons available!

This comparison is by no means a weak one, since according to the official historiography, the planning and construction of the alleged extermination camps in eastern Poland was state policy, and the extermination of the Jews in these camps is supposed to have been one of the chief goals of the Third Reich.

4. The ‘Struggle’ between Engine Exhaust Gases and Hydrogen Cyanide Gas

Among the many absurdities of the so-called ‘Gerstein Report’, a very important one concerns his alleged mission, which Yitzhak Arad summarizes as follows:³²⁵

“The gassing system that had been developed and introduced by Wirth in the Operation Reinhard death camps proved only partially satisfactory. The frequent engine breakdowns caused disturbances and delays in the entire extermination process. Globocnik was aware of these shortcomings and, in coordination with the higher authorities of the SS, decided to look into the possibility of introducing an alternative gassing system. The prevailing opinion among the higher SS authorities in charge of the extermination of the Jews was that Zyklon B was more suitable for this task.

Obersturmführer Kurt Gerstein, the chief disinfection officer in the Main Hygienic Office of the Waffen SS,^[326] and SS-Obersturmbannführer Wil-

³²² Orsat = apparatus for the analysis of combustion gases.

³²³ *Ibid.*, pp. 46-48.

³²⁴ *Ibid.*, pp. 96-103.

³²⁵ Y. Arad, *op. cit.* (note 71), p. 100.

³²⁶ According to Gerstein: SS Main Operations Office, Office Group D, Sanitation Office of the SS, Hygiene Department. PS-2170, p. 2.

helm Pfannenstiel, professor and director of the Hygienic Institute at the University of Marburg/Lahn, who also had served as hygienic adviser to the Waffen-SS, were sent to Lublin in the middle of August 1942.^[327] Gerstein's main mission was to check the possibility of introducing the gas Zyklon B^[328] into the gas chambers. Zyklon B had already been successfully used in Auschwitz, instead of the engines that were still supplying the monoxide gas in the death camps of Operation Reinhard."

Later, Arad explains that Gerstein had "submitted a written report of his mission when he was incarcerated in an American^[329] army prison at the end of the war in April-July 1945",³²⁵ cites an excerpt from this 'report', and concludes:³³⁰

"Gerstein's mission did not bring about any changes in the gassing system in the Operation Reinhard death camps. Carbon monoxide, supplied by truck or tank engine, as introduced by Wirth, remained the means of killing used in these camps. The fact that in Belzec Gerstein witnessed a breakdown of the diesel engine that supplied the gas and during which people were locked inside the gas chamber for almost three hours until the engine started working did not cause any change in the procedure. Wirth refused to give up the gassing system he had developed. His professional pride did not permit him to admit that the use of Zyklon B for mass killings, as developed by Rudolf Höss, the commander of Auschwitz, was preferable to carbon monoxide. He asked and subsequently persuaded Gerstein not to propose any other gas chamber type for Belzec, Sobibor and Treblinka to Berlin. Gerstein did not even carry out any killing experiments with the Zyklon B he had brought with him from Kolin.^[331] The gas was buried on the pretext that it had been spoiled in transit."

5. The 'Mission' of Kurt Gerstein

The tale related by Arad is totally absurd. First of all, let us summarize Gerstein's mission in the way he described it:

³²⁷ In reality, Pfannenstiel had nothing to do with Gerstein's mission and accompanied him "by accident" (see section which follows).

³²⁸ Zyklon B was not gaseous, but rather liquid hydrogen cyanide absorbed on a porous carrier-substance. The gross error committed by Arad here frequently surfaces in the official historiography.

³²⁹ In reality, this was a French military prison, that of Cherche-Midi: Document T-1306, report of the prison physician Dr. Trouillet of July 25, 1945.

³³⁰ Arad, *op. cit.* (note 71), p. 104.

³³¹ According to his own statements, Gerstein had taken along no Zyklon B, but rather liquid prussic acid. See following section.

On March 10, 1941, Gerstein joined the SS³³² and was assigned to the *SS-Führungshauptamt* (SS Main Operations Office), *Amtsgruppe D, Sanitätswesen* (Office Group D, Sanitation) of the *Waffen-SS, Hygiene Department*.³³³ Owing to his success in the field of hygiene, he was soon promoted to *Leutnant* and then to *Oberleutnant*³³⁴ – two ranks, which did not exist in the *Waffen-SS*.³³⁵ In January³³⁶ or February³³⁷ of 1942, he was named head of the Technical Disinfection Service of the *Waffen-SS*. In this capacity, Gerstein received a visit on June 8, 1942, from *SS-Sturmbannführer* Günther of Department IV B 4 of the *SS-Reichssicherheitshauptamt* (RSHA, SS Main Office of Imperial Security),³³⁸ who entrusted him with the task, a mission for the German Reich under utmost secrecy, of taking charge of 100 kg³³⁹ – no, 260 kg³⁴⁰ – of a substance which at the same time was prussic acid (HCN)³⁴¹ and potassium cyanide (KCN),³⁴² and of bringing this by car³⁴³ – no, by a truck³⁴⁴ – to a location that only the driver knew.

Günther's assignment offered Gerstein the opportunity of inspecting the alleged eastern extermination camps. But according to the document "Killing Institutions in Poland,"³⁴⁵ Gerstein had not been selected unsuspectingly for his super-secret mission by the RSHA, but instead had taken the initiative on his own: by making himself useful to SS officers in Poland, he won their confidence and succeeded in obtaining permission to visit the 'killing institutions.'³⁴⁶

On June 8, therefore, Gerstein is given a mission by Günther orally, which 48 hours later, on June 10, is confirmed in writing.³⁴⁷ Nine weeks later, Gerstein and the driver leave for Kolin, near Prague, in order to load the toxic

³³² T-1310.

³³³ PS-2170, p. 2.

³³⁴ T-1310, p. 5.

³³⁵ PS-2164, *Dienstababzeichen der Schutzstaffeln*, IMT, Vol. XXIX, pp. 276f. (Table without pagination). The ranks of *Leutnant* and *Oberleutnant* (first lieutenant) existed only in the *Wehrmacht*. The according SS ranks were *Hauptscharführer* and *Sturmscharführer*.

³³⁶ PS-1553, p. 4; T-1310, p. 5.

³³⁷ PS-2170, p. 2.

³³⁸ Günther was Eichmann's deputy.

³³⁹ T-1310, p. 5; PS-1553, p. 5.

³⁴⁰ PS-2170; George Wellers, "Encore sur le Témoignage Gerstein," in: *Le Monde Juif*, January to March 1980, No. 97, p. 28.

³⁴¹ T-1310, p. 5; PS-1553, p. 5, PS-2170, p. 2.

³⁴² G. Wellers, *op. cit.* (note 340), p. 28; T-1313-b, p. 2.

³⁴³ T-1310, p. 5.

³⁴⁴ PS-1553, p. 5.

³⁴⁵ Anonymous manuscript in the Dutch language, dated March 25, 1943. This is in all probability the translation of a text originating from Gerstein.

³⁴⁶ *Tötungsanstalten in Polen*, published without pagination by L. De Jong, *Een sterfgeval te Auswitz*, Amsterdam 1970, p. 1 of the report.

³⁴⁷ G. Wellers, *op. cit.* (note 340), p. 29.

substance. “By accident,”³⁴⁸ Gerstein takes along Prof. Pfannenstiel, an *SS-Sturmabführer*³⁴⁹ – no, an *Obersturmbannführer*³⁵⁰ – which means that Pfannenstiel had nothing to do with Gerstein’s mission.

Now things begin to get complicated. Gerstein has to pick up³⁵¹ – no, deliver³⁵² – 100 or 260 kg of prussic acid/potassium cyanide. The location of the pickup – or delivery – is specified to Gerstein³⁵³ – no, selected by Gerstein himself;³⁵⁴ the amount of the toxic material is communicated to Gerstein by the RSHA³⁵⁴ – no, determined by Gerstein himself.³⁵⁵

It is worth suggesting here that the working methods of the RSHA in regard to the extermination of the Jews were extremely bizarre, to say the least: Günther entrusted Gerstein with the task of “immediately” taking charge of the toxic substance “for an extremely secret mission for the Reich,”³⁵⁶ but Gerstein permits himself an unusually long time and only gets around to making the trip more than two months later, without any RSHA official having objected. But that’s not all: even stranger, the RSHA revealed the alleged secret to an ordinary driver and to an outsider (Pfannenstiel), but not to the person directly concerned, namely Gerstein!

The goal of Gerstein’s mission was to convert the operational method of the gas chambers from diesel exhaust gases to prussic acid,³⁵⁷ but in blatant contradiction to this Gerstein explained:³⁵⁸

“I understood my mission. [...] It was required of me to discover a more rapid and more effective means of killing than this extermination of primitive type. I proposed the employment of more toxic gases, especially those which give off prussic acid.”

Consequently, he discovered the killing method that the RSHA had told him about earlier, and was proposing precisely the same substance that the RSHA had already selected itself!

In Kolin, however, Gerstein did not pick up Zyklon B – which was produced there – but instead liquid prussic acid in 45 bottles, “after showing an order from the RSHA”,³⁵⁹ in other words, at the command of the RSHA, which is strikingly odd, since liquid prussic acid, a rather dangerous chemical,

³⁴⁸ T-1310.

³⁴⁹ PS-1553, p. 6.

³⁵⁰ PS-1553, p. 7.

³⁵¹ PS-1553, p.5; PS-2170, p. 2; T-1310, p. 6.

³⁵² T-1313-b, p. 2.

³⁵³ G. Wellers, *op. cit.* (note 340), p. 28.

³⁵⁴ *Ibid.*, p. 29.

³⁵⁵ *Ibid.*, p. 30.

³⁵⁶ T-1310, p. 5.

³⁵⁷ T-1310, p. 9.

³⁵⁸ G. Kelber, “Un bourreau des camps nazis avoue: ‘J’ai exterminé jusqu’ à 11,000 personnes par jour’,” in: *France Soir*, July 4, 1945, pp. 1f.

³⁵⁹ G. Wellers, *op. cit.* (note 340), p. 29.

had not been used in Germany for extermination of vermin since the introduction of the ‘tub procedure’ after World War One, and later of Zyklon B.³⁶⁰

Why did the RSHA order Gerstein to take along such an enormous quantity of prussic acid? If one keeps in mind that – according to the verdict of the 1965 Munich Court of Assizes – the six alleged gas chambers of Bełżec are supposed to have had an effective volume of 145 m³, if one subtracts the space taken up by the approximately 1,500 victims,³⁶¹ then 500 g of prussic acid would have been sufficient to theoretically reach over ten times the instantly lethal concentration in every gas chamber. Under these circumstances, the 100 kg of prussic acid, which Gerstein says he brought with him, would have sufficed to kill 300,000 people in 200 gassings! This quantity was obviously too large for a few simple experiments. For these, about a dozen canisters of Zyklon B would have been enough and, if he was going to Lublin anyway, Gerstein would have easily been able to pick these up at the Majdanek Camp, where the Tesch & Stabenow firm had just delivered 360 Zyklon B canisters of 1.5 kg each, thus 540 kg total, two weeks before, on July 30, 1942.³⁶²

In Lublin, Gerstein was received by *SS-Brigadeführer* Odilo Globocnik, who disclosed the existence of the extermination camps of Bełżec, Sobibór, and Treblinka to him:³⁶³

“This secret Reich matter is currently one of the most secret, one might say the most secret that there is.”

Thereupon Globocnik explained to him what his main mission was:³⁶⁴

“Your other – even far more important – mission is the conversion of our gas chambers, which are now working with diesel exhaust, to a better and quicker way. I am mainly thinking of prussic acid.”

Thus Gerstein went to Bełżec with his death-dealing cargo but did not carry out his mission, and then he coolly returned to Berlin, without having to report to anyone about that mission, which had been an urgent, top secret matter.

³⁶⁰ O. Lenz, L. Gassner, *Schädlingsbekämpfung mit hochgiftigen Stoffen*, Number 1: “Blausäure”. Richard Schoetz, Berlin 1934, pp. 8-10. The ‘tub procedure’ developed HCN by pouring semi-concentrated sulfuric acid over potassium cyanide in a tub. Liquid prussic acid tends to explosively polymerize and was therefore permitted to be transported only in its frozen state, at night, and with a special vehicle: Frankfurt/Main Court of Assizes, session of March 28, 1949, in: C.F. Rüter, *Justiz und NS-Verbrechen. Sammlung deutscher Strafurteile wegen nationalsozialistischer Tötungsverbrechen, 1945-1966*, Amsterdam 1968-1981, Vol. XIII, p. 137.

³⁶¹ The number 1500 at one gassing of people crammed into the ‘gas chambers’ was given in the verdict at the trial of Josef Oberhauser (January 1965). A. Rückerl, *NS-Vernichtungslager...*, *op. cit.* (note 61), p. 133.

³⁶² J. Graf, C. Mattogno, *op. cit.* (note 270), p. 202.

³⁶³ PS-2170, p. 3.

³⁶⁴ T-1310, p. 9.

This story seemed suspicious to the French Examining Magistrate Mattei, who interrogated Gerstein on July 19, 1945:³⁶⁵

“Question: ‘To whom did you give an account of the execution of your mission?’

Answer: ‘After my return to Berlin from a journey, which had lasted about two weeks, I gave no one a report about the execution of my mission. No one asked me anything.’”

The absurd answer did not satisfy Mattei, and he probed further:³⁶⁶

“Therefore, according to your own admission, you received an important mission in Berlin in your capacity as technician, a mission which was so important that you had to carry it out as a state secret, you visited three camps and were given an audience by a general, who, in view of the purpose of your mission, considered it necessary to communicate to you the remark of the two great Nazi leaders.^[367] How can you persist in wanting to convince us that you:

- 1) Did not fulfill the goal of your mission at all;*
- 2) Reported to no one;*
- 3) No one put any sort of questions to you concerning this?”*

Gerstein answered:

“Hauptmann [Captain] Wirth was so close to Himmler that he could say to me that I didn’t have to trouble myself about this matter any more, and I obeyed him in this.”

This defensive strategy was demolished by Gerstein himself when he stated:³⁶⁸

“Wirth asked me to propose no change in the gas chambers and killing methods used up to now, since everything had worked out and proved most effective. Remarkably, I was never asked about that sort of thing in Berlin.”

Thus, Christian Wirth did not have such great influence with Himmler after all! This is also ‘confirmed’ by the allegation that Wirth was afraid of Gerstein:³⁶⁹

“Hauptmann Wirth comes in. One sees that he is afraid because I see the disaster.”

Gerstein’s tale is based upon three premises:

1. The extermination of Jews in the eastern camps was a Reich secret; indeed, it was the most secret matter of all.

³⁶⁵ G. Wellers, *op. cit.* (note 340), p. 29.

³⁶⁶ *Ibid.*, p. 32.

³⁶⁷ Hitler and Himmler, who according to Gerstein are supposed to have visited the eastern ‘extermination camps’ on August 16, which is, however, historically untrue.

³⁶⁸ PS-2170, p. 7.

³⁶⁹ PS-1553, p. 6. The “disaster” was the breakdown of the diesel engine at the alleged gassing of people, which Gerstein claims he attended.

2. It had therefore been planned at the level of Himmler, through Department IV B 4 of the RSHA (Eichmann).
3. The implementation of the extermination plan had been entrusted to Globocnik, who was directly responsible to Himmler for it.

The RSHA allegedly gave Gerstein the job of changing the way the gas chambers functioned. Therefore, the order had to have been issued by Himmler. Himmler had supposedly done so because the system employed at that time – diesel engine exhaust gases – was unsatisfactory. Globocnik had been in full agreement with this, and only he would have been able to inform Himmler about the inefficiency of this method of extermination.

According to Michael Tregenza, Globocnik ordered the restructuring of Treblinka after inspecting it on August 19, 1942, and entrusted this task to Christian Wirth as “Inspector of the SS-Sonderkommando ‘Operation Reinhard.’”³⁷⁰

We therefore return to our earlier question: How can so inefficient a technique for carrying out the Reich’s secret extermination program have been okayed at the highest governmental level?

Gerstein belonged to the SS Main Operations Office, Office Group D, Sanitation, of the Waffen-SS, Hygiene Department. Why did the RSHA turn to this office in order to change the killing system then in operation, yet not inquire about a more effective one? If the use of engine exhaust gases had been planned, why hadn’t the RSHA contacted the *Reichsgesundheitsamt* (Reich Office of Health) in Berlin and the research laboratories of I.G. Farbenindustrie, which, as we have seen, had substantial experience in this field at its disposal?

If the RSHA had decided to use prussic acid in the gas chambers, why did it commission Gerstein to pick up liquid prussic acid instead of Zyklon B?

And finally, if the diesel exhaust gas chambers proved to be so inefficient, why had their method of operating not been changed?

Thus, although the killing method allegedly used in Bełżec had been proven to be inefficient and the RSHA – *i.e.* Himmler – is supposed to have decided to modify it at the beginning of June 1942, the construction of the second gassing installation in Treblinka at the end of August/beginning of September 1942 is supposed to have begun using exactly the same inefficient diesel principle! And who – apart from Himmler – could have issued the order for the construction of this second installation?

Thus, the ‘Gerstein Report’, which Arad describes as “one of the first and most important documents relating to Operation Reinhard” (sic),³⁷¹ is not only devoid of any sort of evidentiary weight, but on the contrary, it also sheds ad-

³⁷⁰ M. Tregenza, *op. cit.* (note 298), pp. 9f.

³⁷¹ Arad, *op. cit.* (note 71), p. 102.

ditional light upon the complete absurdity inherent in the entire story of the ‘eastern extermination camps.’

6. Russian Engines or German Engines?

Yet we have not reached the end of absurdities. How can one believe, in all seriousness, that for the implementation of such an important government program as that of a ‘secret Reich matter’ old Russian diesel engines would have been used?³⁷² Where did the SS intend to procure spare parts for repairs when the inevitable wear and tear occurred?

But there is an even more basic problem. In Chapter II we spoke of the electric power supply of Treblinka, which consisted of an engine and an electric generator driven by it. We have further seen how, according to the witness Wiernik, the alleged gas chambers were operated by the exhaust gases of this engine.

Aside from the ludicrousness of a mass killing by means of diesel exhaust gases, just how plausible it is is shown by Friedrich Berg:³⁷³

“The only way to realistically impose a significant load on any engine is by coupling to the engine some kind of brake dynamometer or other load, such as a generator with an electrical load, a fan, pump, or the like.”

According to the witness Wiernik, it was the engine that supplied Treblinka’s electric power that was used for the gassings there. This engine was thus doubly important; first, because it had to produce carbon monoxide for the gassings, and second, because it generated the electrical energy indispensable for the needs of the camp. In fulfilling the second function, the engine had to be in operation 24 hours every day. How can one conceive of the notion that the RSHA and the SS-WVHA could have been satisfied with a Russian engine for the fulfillment of this double function? The whole story sounds all the sillier in view of the fact that the emergency electric supply of the Auschwitz Camp had been equipped with a new German diesel engine since November 1940. The firm of Georg Grabarz compiled a detailed cost estimate, of which we have photocopied the first page, for the local SS Central Construction Office.³⁷⁴ The costs for the engine amounted to 28,140 RM, that for the generator 24,464 RM, and the entire costs, including accessories and costs of transport, 56,218 RM.³⁷⁵

³⁷² Auerbach mentions a “Russian tank engine” (*op. cit.* (note 29), p. 49) for Treblinka. Wiernik speaks of a “dismantled Soviet tank” (in A. Donat, *op. cit.* (note 4), p. 157). According to Gerstein, in Bełżec the exhaust gases “from an old Russian diesel engine” were used (PS-2170, p. 3).

³⁷³ F. P. Berg, *op. cit.* (note 98), p. 455.

³⁷⁴ See Document 21 in the Appendix.

³⁷⁵ About \$500,000 in present value.

7. Gas Chambers or Asphyxiation Chambers?

According to the verdict of the Düsseldorf Court of Assizes of September 3, 1965, already cited, the gas chambers of the first killing installation measured $4\text{ m} \times 4\text{ m} \times 2.60\text{ m}$ each, thus 16 m^2 and 41.6 m^3 , and could each hold 200 to 350 people. Those of the second killing installation were $8\text{ m} \times 4\text{ m} \times 2\text{ m}$, thus 32 m^2 and 64 m^3 in size, and could accommodate 400 to 700 persons.³⁷⁶

The time period, during which one can be enclosed in a gas-tight air-raid shelter (equipped with neither ventilation nor an air-exchange system) without danger to health and life, can be calculated on the basis of the following equation:

$$t = v/20n (10-0.4) = 0.48 (v/n)$$

in which t stands for the time spent in the shelter, v for the volume of the room in cubic meters, n is the number of occupants of the room. The constant 20 designates the number of liters of carbon dioxide exhaled by a person within an hour, and 0.4 refers to the liters of carbon dioxide present per cubic meter of air. Lastly, 10 is the highest possible permissible concentration of carbon dioxide (per m^3) in the shelter.

By using this equation, the suffocation of the occupants of the shelter can be avoided. It is well known that an adult normally exhales 4% carbon dioxide (CO_2). Though this gas is not toxic, a concentration beyond a certain point leads to death through asphyxiation. On average, a standing adult breathes eight liters of air per minute and in doing so uses 0.360 liters of oxygen; during slow walking, however, his consumption of oxygen climbs to 0.65 liters per minute, and the air exhaled during the same period is increased to 14 liters. Since in respiration four parts of carbon dioxide are produced for 5 parts of oxygen, the person in the first instance produces

– $(0.36 \times 4/5 =) 0.288$ liters of carbon dioxide per minute,

and in the second case

– $(0.65 \times 4/5 =) 0.520$ liters of carbon dioxide per minute.³⁷⁷

In regard to the effects of carbon dioxide upon people in relation to its concentration, two specialists, Flury and Zernik, write:³⁷⁸

“With 8-10%, corresponding to 144-180 mg/liter, loss of consciousness rapidly ensues and death follows from cessation of breathing with cyanosis. Convulsions are insignificant or entirely absent. The heart continues to beat after cessation of breathing. A concentration of 20%, or approximately 360 mg/liter, leads within a few seconds to complete paralysis of the vital centers.”

³⁷⁶ This corresponds up to 22 persons per square meter – an absolute impossibility!

³⁷⁷ F. Flury and F. Zernik, *Schädliche Gase, Nebel, Rauch- und Staubarten*, Publishing House of Julius Springer, Berlin 1931, pp. 26f., 29.

³⁷⁸ *Ibid.*, p. 219.

Thus a carbon dioxide concentration of 10% leads to death in a few minutes, while at the same time the oxygen content has fallen to 8.5% ($21\% - [10\% \times (5 \div 4)]$). In what time period would there have been such a concentration in the alleged gas chambers of Treblinka?

Since there were also children among the alleged victims – perhaps a third of the entire number³⁷⁹ – and since the rate of respiration of the hypothetical victims would naturally have been accelerated by excitement, fear, and terror, we start our calculations with the assumption of an average carbon dioxide volume of 0.300 liters per person per minute³⁸⁰ or 18 liters per person per hour, and with the average weight of each victim assumed to be 55 kg.³⁸¹

Gassing Installation 1:

The number of victims per gas chamber amounted to 200 to 300, thus an average of 275. The volume occupied by the bodies of the victims amounted to $((275 \times 550) \div 1,000 =)$ 15.1 m³; therefore, there was a volume of $(41.6 - 15.1 =)$ 26.5 m³ of air available. In one minute the victims produced $(275 \times 0.3 =)$ approximately 82.5 liters or 0.0825 m³ carbon dioxide.

The lethal concentration lies at 10% carbon dioxide, which corresponds to $(26.5 \times 0.1 =)$ 2.65 m³ or 2,650 liters. This thus occurs in $(2,650 \div 82.5 =)$ about 32 minutes.

Gassing Installation 2:

The number of victims per gas chamber amounted to 400 to 700, therefore an average of 550. The volume occupied by the bodies of the victims is $(550 \times 550 \div 1,000 =)$ 30.2 m³; thus a volume of $(64 - 30.2 =)$ approximately 34 m³ is available. In one minute the victims produce $(550 \times 0.3 =)$ approximately 165 liters or 0.165 m³ carbon dioxide. The lethal concentration of 10% carbon dioxide, that is, $(34 \times 0.1 =)$ 3.4 m³ or 3,400 liters, is consequently attained in $(3,400 \div 165 =)$ about 21 minutes.

Conclusion:

According to the witnesses, the victims are supposed to have died from the gas after approximately 30 to 40 minutes, but death from asphyxiation would have already occurred after about 20 or 30 minutes. What good purpose, therefore, was served by the construction of diesel gas chambers?

³⁷⁹ According to the statistician Jakob Leszczyński, in the year 1931 children made up 29.6% of the population in Poland. L. Poliakov, J. Wulf, *Das Dritte Reich und die Juden. Dokumente und Aufsätze*, Arani Verlag, Berlin-Grünwald 1955, p. 231.

³⁸⁰ This value is based upon the average of the above stated values for the number of respirations: $(0.288 + 0.520) \div 2 =$ approx. 0.400 liters per minute for an adult and $(0.4 + 0.4 + 0.2) \div 3 =$ approx. 0.300 liters per minute for each person (this assumes that children make up about a third of the total).

³⁸¹ We assume a weight of 70 kg for adults and of 25 kg for children, in which the number of the latter is three times less numerous.

But we still are not yet done with the absurdities. Rachel Auerbach writes:³⁸²

“For instance, we had believed for a long time that the final agony in the gas chambers, where most of our relatives and friends were asphyxiated, lasted just 20 to 25 minutes, or half an hour at the most. We have now learned from Jankiel Wiernik’s account that the death throes in the new, larger gas chambers (in Treblinka) took longer than it had in the old chambers. In fact, they often went on for as long as one hour because the Russian tank motor which supplied the chambers with exhaust fumes did not put out gas sufficient to fill the larger space and the wider pipes. The output was not sufficiently large and effective.”

This illuminates a gross error in planning, which would have been committed by the SS if these claims were correct. The second gassing installation allegedly had 10 gas chambers with a total volume of 640 m³, while the first had merely three gas chambers with a total volume of 124.8 m³. Therefore the volume of the second installation was approximately five times greater than that of the first. In order to kill the victims in the same time as in the first installation, the SS would consequently have had to install five engines in the second instead of a single one.

In his report published in 1944, Wiernik had only written:³⁸³

“The motor which generated the gas in the new chambers was defective, and so the helpless victims had to suffer for hours on end before they died. Satan himself could not have devised a more fiendish torture.”

Quite clearly, Wiernik’s claim was pure atrocity propaganda: he wanted to create the notion that death in the new facility was even more cruel than in the old one, because the SS was using a defective engine (or perhaps even had intentionally damaged it!), and on that account the victims had to endure a torture that the Devil incarnate could not have improved on!

If, as Wiernik maintains on the other hand, 10,000 to 12,000 people per day were gassed in Treblinka,³⁸⁴ – or even, at times, 20,000³⁸⁵ – then this certainly does not jibe with the inefficiency of the gas chambers as described by the same witness.

Who can seriously believe that the RSHA, after its decision to change the killing system of the first gassing facility of Treblinka because it had proven too inefficient (as was likewise the case with Bełżec and Sobibór), would have allowed a new installation to be built, which functioned on the same system but was even less efficient? As always in such cases, the stupidity lies not with the SS, but rather with the eyewitnesses.

³⁸² A. Donat, *op. cit.* (note 4), p. 49.

³⁸³ A. Donat, *op. cit.* (note 4), p. 164; J. Wiernik, *A Year in Treblinka*, *op. cit.* (note 164), p. 20.

³⁸⁴ *Ibid.*, p. 16.

³⁸⁵ *Ibid.*, p. 21.

8. The Problem of Air Pressure in Gas Chambers

According to the official historiography, the gas chambers possessed no vent for removal of gas. As we have seen in Section 2, the Soviet Examining Judge Jurovski drew in an opening for gas outflow in the ceiling in both of his drawings of the gas chambers of Treblinka. In 1947, Elias Rosenberg stated for the record:³⁸⁶

“A small window, sealed air-tight, was fitted to the ceiling, which could not be opened and through which the man who regulated the gas supply was able to observe.”

This small window, therefore, had nothing to do with any system for gas removal. But such a window, or, to be more exact, such an opening, for the purging of the air-gas mixture would have been absolutely indispensable for a mass killing employing the exhaust gases of a powerful engine. Graduate engineer Arnulf Neumaier emphasizes that diesel engines emit their combustion gases with a pressure of 0.5 atmospheres (which corresponds to 500 g/cm²), and explains:³⁸⁷

“[...] this means that there would have been a force equivalent to the weight of 5 metric tons pushing outward against each square meter of surface area.”

In the first installation, such a pressure would have exerted a force corresponding to the weight of 80 metric tons upon the ceiling of each chamber, of 52 metric tons on each of the walls, of 8.1 metric tons upon the entrance door and of 22.5 metric tons upon the door serving for the removal of the bodies. If the masonry of the walls had withstood this powerful pressure, then the engine, approaching a state of equilibrium between the pressure of the interior of the chambers and the pressure of the engine exhaust gases, would have broken down.

When would this equilibrium have been reached? The gas pressure in a hermetically sealed container or room doubles if the amount of gas in it is doubled (provided the temperature is constant).

A diesel engine works like a compressor. Within the parameters of the data given previously, an engine of 38,860 cubic centimeters (38.86 liters) at 2,000 RPM emits 38.86 m³ of gas per minute with an outlet pressure of 0.5 atmospheres.

The effective air volume amounts to (26.5×3=) 79.5 m³ in the first and (34×10=) 340 m³ in the second installation. Under these conditions, a pressure of 0.5 atmospheres would be attained if a volume of exhaust gas had been blown into the rooms that corresponded to half of their effective volume, therefore (79.5÷2=) 39.75 m³ in the first and (340÷2 =) 170 m³ in the second

³⁸⁶ E. Rosenberg, *op. cit.* (note 187), p. 136 (p. 4 of the report).

³⁸⁷ A. Neumaier, *op. cit.* (note 219), p. 485.

installation. This would have taken $(38.25 \div 38.86 =)$ less than a minute in the first installation, but $(170 \div 38.86 =)$ a little more than four minutes in the second.

If the alleged gas chambers were actually hermetically sealed, the gassing procedure under the circumstances described by the witnesses would therefore have come to a standstill through breakdown of the engine after scarcely a minute in the first facility, and after a little over four minutes in the second facility, if the walls of the building had not already collapsed. But probably the doors would not have withstood the pressure and been blown off their hinges.

9. The Burning of Bodies: The Mass Graves

a. Number and Size of the Graves

According to official historiography, about 860,000 of the 870,000 Treblinka victims were buried before their cremation.³⁸⁸

On the basis of his investigations of the mass graves of Hamburg (Anglo-American terror-bombardment of July 1943), Katyn (Soviet mass murder of Polish officers, 1940) and Bergen-Belsen (mass deaths from typhus in spring 1945), John Ball came to the conclusion that one could assume a maximum of six bodies per cubic meter in a mass grave.³⁸⁹ This number seems quite high if one keeps in mind that in Treblinka I, the work camp, the Soviets found 105 bodies in a grave with an effective volume of 75 m^3 – therefore 1.4 bodies per cubic meter, and that the medical expert Piotrowski, in his first calculation of the content of the mass graves, set a figure of six bodies per 2 cubic meters, thus 3 bodies per cubic meter, half the density proposed by Ball.³⁹⁰ However, in order to take into account the hypothetical existence of children as comprising one-third of the victims, we assume a density of a maximum of 8 bodies per cubic meter.

How many graves were there, and how large were they? The Düsseldorf Court of Assizes conceded at the trial of 1964-1965 that it had discovered no accurate information about this. In its verdict it says:³⁹¹

“The details determined in the main trial concerning the number and size of the body pits likewise differ very widely from one another. Nevertheless, one can form an idea of the extent of the pits when one hears that, accord-

³⁸⁸ According to Arad, *op. cit.* (note 71), p. 396, 7,600 people were gassed in August 1943 and directly cremated without an intervening period of burial.

³⁸⁹ John Ball, in: Germar Rudolf (ed.), *op. cit.* (note 80), p. 264.

³⁹⁰ See Chapter III. In the two other mass graves, the number of bodies per cubic meter was even lower.

³⁹¹ A. Rückerl, *NS-Vernichtungslager...*, *op. cit.* (note 61), pp. 204f.

ing to the statement of defendant S., one of the pits contained no less than approximately 80,000 corpses.”

But according to the witness E. Rosenberg, who is the sole person to give ‘exact’ details, the mass graves measured $120\text{ m} \times 15\text{ m} \times 6\text{ m}$,³⁹² which, if one assumes a top layer of 0.5 m, gives an effective volume of $(120 \times 15 \times 5.5 =) 9,900\text{ m}^3$. Consequently, each grave could contain $(9,900 \div 8 =) 79,200$ bodies, which agrees almost exactly with the comment above of the Düsseldorf Court.

In accordance with this, if 860,000 bodies were really buried in Treblinka before their cremation, there must have been $(860,000 \div 79,200 =) 11$ graves of this size, the total surface area of which amounted to $(120 \times 15 \times 11 =) 19,800\text{ m}^2$.

b. Site of the Mass Graves

According to the plan of Treblinka produced at the Düsseldorf trial of 1964-1965, the mass graves were located without exception inside of ‘Camp II,’ where there were, besides, the following facilities: the old gassing installation, the new gassing installation, the two cremation grates and the barracks for the Jewish *Sonderkommandos*. But, as pointed out in Chapter II, the whole of ‘Camp II’ had an area much smaller than the theoretical area of the graves, that is, $14,000\text{ m}^2$.

‘Camp II’ had the shape of an irregular quadrilateral; its sides measured 188, 110, 174, and 52 meters. It therefore could theoretically accommodate merely three graves of the dimensions given above. Due to the presence of the five facilities mentioned, however, of which three (the two cremation grates and the new gassing installation) were allegedly lined up with one another on an east-west axis, ‘Camp II’ could barely have contained a single one such mass grave for 79,200 bodies. Where, then, were the remaining 780,800 bodies buried?

In the plan mentioned, just five mass graves are drawn in ‘Camp II,’ which further complicates things, since each grave would then have to have had a far greater area than stated above.

c. The Excavated Earth

In excavating a pit or a grave, the extract has a volume which is normally around 10 to 25% greater than the volume of the excavated pit itself.³⁹³ From each of the 11 mass graves of Treblinka, $(120 \times 15 \times 6 =) 1,088$ cubic meters of earth would have been excavated, thus in all $(10,800 \times 11 =) 118,800$ cubic meters. If we set the minimum of 10 % for the additional volume of the extracted earth, then the latter would have had a volume of $(118,800 \times 1.1 =)$ approx.

³⁹² E. Rosenberg, *op. cit.* (note 187), p. 137 (p. 5 of the report).

³⁹³ G. Colombo, *Manuale dell'ingegnere civile e industriale*, Enrico Hoepli Editore, Milan 1926, p. 237.

130,700 cubic meters. For purposes of illustration, let it be said that this enormous quantity of earth would have been able to cover the entire surface area of the Treblinka II camp with a layer nearly one meter high! If this mass were arranged in the form of a pile 6 m high, with sides each having an angle of 30 degrees and a width of 10 m, then its length would have amounted to $(130,700 \div 30 \cong)$ 4.4 kilometers, covering some 44,000 m²! If one constructed such a pile of soil next to each grave, then each pile would be some 390 m long each!

d. A Comparison with the Mass Graves of Treblinka I

As shown in Chapter III, in the year 1944 the Soviets found three mass graves in the proximity of Treblinka I, and the Poles a further 41 in 1946. The latter possessed a total area of 1,607 m². Not a single mass grave was discovered on the camp area itself, although this had a greater area than Treblinka II: approximately 18 hectares.³⁹⁴

The graves were located in the forest of Maliszewa, about 500 m away from the camp. This was due to obvious considerations of hygiene and sanitation.

The pollution of water, air, and soil by decomposing corpses had been proven scientifically a long time before the 1940s. Studies performed in the nineteenth century had shown that the ground water in the vicinity of cemeteries was often so severely contaminated that the water in the wells was putrid, murky, and permeated by organic substances. In 1878, F. Selmi, Professor of Pharmaceutical and Toxicological Chemistry at the University of Bologna, discovered that in addition to ammonia, sulfuric acid, carbonic acid, and gaseous hydrocarbons, a toxic alkaloid is also generated through the decomposition of corpses, which he named 'ptomaine.' At about the same time, other scientists proved that cadavers develop yet another volatile toxic substance, 'sepsin.' Moreover, it had already long been experimentally proven that many pathogenic microorganisms in the soil – the cause of typhus fever being among them – are very capable of resisting atmospheric effects.³⁹⁵ In Treblinka, according to S. Rajzman, typhus fever constituted "the main plague."³⁹⁶

The water supply of the camp was secured by wells. On the plan of Treblinka drawn by Moszek Laks and Maniek Płatkiewicz,³⁹⁷ four wells can be recognized, one for the German guard unit, one for the Ukrainian guard unit, one for the Jewish prisoners, and a fourth, which was surely located in 'Camp

³⁹⁴ S. Wojtczak, *op. cit.* (note 60), p. 120.

³⁹⁵ Luigi Maccone, *Storia documentata della cremazione presso i popoli antichi ed i moderni con particolare riferimento all'igiene*, Istituto Italiano d'Arti Grafiche, Bologna 1932, Part Three, Chapter II, "Infezioni e cimiteri," pp. 148-157; M. Pauly, *Die Feuerbestattung*, Leipzig 1904, pp. 21-25.

³⁹⁶ USSR-337. GARF, 7445-2-12, p. 239.

³⁹⁷ See Document 14 in the Appendix.

II.' There can therefore be no doubt that hundreds of thousands of bodies allegedly buried in 'Camp II' would have completely poisoned the ground water, which supplied the wells. Yet not a single witness mentions a thing about this critical problem.

e. The Excavators of Treblinka

According to the official version of history, the existence of huge mass graves is confirmed by the presence of three excavators in the camp, which at first are supposed to have been employed for the excavation of the graves and later for exhuming the corpses. Two photos are often published in support of this claim, in which excavators – allegedly at a location in Treblinka II – can be recognized. One of these photos is reproduced in Arad's book with the caption:³⁹⁸

"An excavator used in Treblinka to remove dead bodies to be burned, and the SS men who operated the excavator."

The other, better-known photograph appeared, inter alia, in the work of Gitta Sereny, where the caption claims that the excavator served to transport the corpses out of the trenches onto the grates.³⁹⁹ This photo was also published in the book *The Good Old Days* with the caption:⁴⁰⁰

"Excavator used for corpses in Treblinka."

Samuel Willenberg's book contains a picture of said excavator in action, dumping a load of – soil. The picture bears the caption:⁴⁰¹

"Crane lifting corpses for cremation. Photographed by SS man Kurt Franz, nicknamed 'Lalka' (Doll)."

R. Czarkowski has published the same snapshot with the comment "Excavator for the excavation of the graves for the victims."⁴⁰² Furthermore, it is supposed to follow from German documents – never published, however – that on June 29, 1943, an excavator from Treblinka was sent to the Adam Lamczak firm in Berlin; two more excavators were supposedly shipped to Lublin or Poniatowa or Trawniki in November 1943 (the exact date and exact place of destination are not named).⁴⁰³ It apparently occurred to nobody that in reality these excavators could have been stationed in Treblinka I, where they found employment in the mining of gravel in the pit there. The sole 'proof' for the presence of these machines in Treblinka II is two drawings produced by S.

³⁹⁸ Y. Arad, *op. cit.* (note 71), p. 95.

³⁹⁹ G. Sereny, *Into That Darkness*, McGraw-Hill, New York 1974, photo on unnumbered page.

⁴⁰⁰ Ernst Klee, Willi Dreßen, Volker Rieß, *The Good Old Days*, New York: Free Press, 1991, p. 246.

⁴⁰¹ S. Willenberg, *Surviving...*, *op. cit.* (note 82), Plate 4, unnumbered page.

⁴⁰² R. Czarkowski, *op. cit.* (note 75), photo on unnumbered page.

⁴⁰³ S. Wojtczak, *op. cit.* (note 60), pp. 149f.

Willenberg in the 1980s, in which one sees a part of the camp with an excavator in the background!⁴⁰⁴

10. Early Cremations

Arad describes the early history of the alleged burning of bodies in Treblinka as follows:⁴⁰⁵

“During Himmler’s visit to the camp at the end of February/beginning of March 1943, he was surprised to find that in Treblinka the corpses of over 700,000 Jews who had been killed there had not yet been cremated. The very fact that the cremation began immediately after his visit makes it more than possible that Himmler, who was very sensitive about the erasure of the crimes committed by Nazi Germany, personally ordered the cremating of the corpses there. A cremation site was erected for this purpose in the extermination area of the camp.”

Here Arad is simply repeating what Łukasziewicz had written in 1945:⁴⁰⁶

“In February or March 1943, Himmler visited the camp (witnesses: Poswolski, Stanisław Kon, Wiernik, Kudlik, Reisszmann [sic]. After this visit the bodies were cremated in mass.”

This claim is untenable just as much from the standpoint of the witness testimony as it is historically invalid. Rajzman had stated in particular at his first interrogation on September 26, 1944:⁴⁰⁷

“In the first months – as I was told – the bodies were buried and covered with a layer of earth, at which point the dentists extracted the gold teeth as soon as the bodies were dragged out of the chambers. At my arrival in the camp, the bodies were being burned in primitive furnaces, the pyres blazed day and night. Clouds of smoke covered the sky over the camp to the point that we entered into a constant zone of darkness.”

Rajzman came to Treblinka on September 27, 1942, which means that the cremation of bodies must have already begun in September of that year and not first in March 1943.

On the other hand, the story of the Himmler visit to Treblinka is devoid of any sort of historical basis and is not even supported by a vague documentary reference. It is a simple invention of the witnesses in order to make their tales of enormous cremations in Treblinka appear credible, which tales are then

⁴⁰⁴ S. Willenberg, *Revolt...*, *op. cit.* (note 82), drawings on unnumbered pages.

⁴⁰⁵ Y. Arad, *op. cit.* (note 71), pp. 173f.

⁴⁰⁶ USSR-344. GARF, 7445-2-126, p. 320a (p. 4 of the report).

⁴⁰⁷ USSR-337. GARF, 7445-2-126, p. 242.

supposed to lend credibility to their description of a gigantic mass extermination in the camp. But historically viewed it is all sheer nonsense.

According to official historiography, Himmler, at a point in time when Auschwitz, allegedly the largest of the German ‘extermination camps,’ began its murderous activity, had not yet thought of building crematoria for the incineration of corpses: the victims of the so-called ‘bunkers’ of Birkenau are supposed to have simply been buried in mass graves, which had been dug in the ‘*Birkenwald*’ (birch forest). Himmler is supposed to have ordered the cremation of bodies in Auschwitz after his second visit there on July 17 and 18, 1942.⁴⁰⁸ As a result of this alleged Himmler order, the incineration of the bodies under the open sky is supposed to have begun on September 21, 1942.⁴⁰⁹

But during the month before his visit to Auschwitz, Himmler is supposed to have ordered the *SS-Standartenführer* Paul Blobel, through the chief of the Gestapo, Heinrich Müller, to eradicate all traces of the mass graves:⁴¹⁰

*“In June 1942 SS-Gruppenführer Müller, chief of the Gestapo, charged SS-Standartenführer Blobel with removing all traces of the mass executions carried out in the east by the Einsatzgruppen. This order was considered a state secret, and Blobel was instructed to refrain from any written correspondence on the subject. The operation was given the code name ‘Sonderaktion (special operation) 1005.’”*⁴¹¹

Given the above, it is incomprehensible that corpses were buried in Auschwitz up until September 20, 1942, and in Treblinka up to March 1943; it is similarly inexplicable that cremations in Sobibór are supposed to have begun in the summer of 1942,⁴¹² those in Bełżec in the middle of December 1942,⁴¹³ and those in Treblinka in March 1943.

Or, to put it differently, we understand all too well: the witnesses of the different camps did not manage to get together to agree on an identical starting date for Himmler’s decision to eradicate all traces by cremation!

⁴⁰⁸ Franciszek Piper, “Gas Chambers and Crematoria,” in: Israel Gutman, Michael Berenbaum (eds.), *Anatomy of the Auschwitz Death Camp*, Indiana University Press, Bloomington and Indianapolis 1994, p. 163.

⁴⁰⁹ D. Czech, *Auschwitz Chronicle, 1939-1945*, H. Holt, New York 1990, p. 242.

⁴¹⁰ E. Kogon *et al.* (eds.), *op. cit.* (note 65), p. 187.

⁴¹¹ We will return to this claim in Chapter VII.

⁴¹² Y. Arad, *op. cit.* (note 71), p. 171.

⁴¹³ *Ibid.*, p. 172.

11. Cremation Facility

Łukaszkiwicz writes:⁴¹⁴

“In Treblinka there were no crematoria in the form of ovens, only primitive facilities in the form of grates.”

Had Treblinka been a ‘pure extermination camp,’ then it would have been the sheerest insanity *not* to construct crematoria. All important concentration camps – Dachau, Sachsenhausen, Buchenwald, Mauthausen, Flossenbürg, Neuengamme, Groß-Rosen, Niederhagen, Ravensbrück – were equipped with stationary or mobile crematorium furnaces. Lublin/Majdanek and Auschwitz-Birkenau, which supposedly functioned simultaneously as concentration and extermination camps, possessed several crematoria: the former camp had two of them with seven muffles altogether,⁴¹⁵ the latter, five crematoria with a total of 52 muffles (although not all functioning in the same time period).⁴¹⁶ Why did Himmler not provide for the building of even a single furnace for an alleged *pure* extermination camp?

It gets even crazier: on December 4, 1941, Himmler himself had ordered through the SS Main Office for Budget and Buildings “4 pieces of Topf 4-muffled double cremation furnaces” from the Topf firm in Erfurt for the White Russian city of Mogilev, which was then under German military administration⁴¹⁷ and where the transit camp for POWs No. 185 under the command of Major Wittmer was located.⁴¹⁸ But on December 30, 1941, merely half a furnace (four muffles) was shipped to Mogilev; two others were then installed in crematoria IV and V of Auschwitz-Birkenau, and 1½ more ovens (12 muffles) remained temporarily in storage at the Topf firm at Himmler’s disposal.⁴¹⁹ On August 16, 1943, the SS Administrator at the Senior SS and Police Chief’s office in the General Gouvernement delivered a memo to all Central Construction Offices of the General Gouvernement (occupied Poland) as well as to the Construction Office of Radom, in which they were informed that Office CIII of the *SS-WVHA* had available “1½ cremation furnaces = 12 muffles” and asked that notification be given by September 1, if the officials named required them.⁴²⁰ We know only the response of the construction director of Trawniki, a subcamp to Majdanek, who wrote:⁴²¹

⁴¹⁴ USSR-344. GARF, 7445-2-126, p. 321 (p. 5 of the report).

⁴¹⁵ See J. Graf, C. Mattogno, *op. cit.* (note 270), Chapter V.

⁴¹⁶ See C. Mattogno, “The Cremation Furnaces of Auschwitz” in: G. Rudolf (ed.), *op. cit.* (note 80), pp. 367-407.

⁴¹⁷ Letter from the Head Office of Budget and Construction to the Topf firm, dated December 4, 1941, RGVA, 501-1-328, pp. 347f.

⁴¹⁸ Christian Gerlach, *Kalkulierte Morde*, Hamburger Edition, Hamburg 1999, p. 510.

⁴¹⁹ Letter of the Topf firm to the Central Construction Office unit of Auschwitz, RGVA, 502-1-327, pp. 43-45.

⁴²⁰ WAPL, Central Construction Office, 268, p. 132.

⁴²¹ WAPL, Central Construction Office, 268, p. 147.

“There is no crematorium in the local camp. This situation has repeatedly been the cause of complaints. The installation of a crematorium would be urgently needed.”

Because there had been confusion about payments of invoices from the Topf firm, the SS Administrator of Group C/Construction also contacted the office of the Senior SS and Police Chief of Central Russia, since the ordering of the “4 pieces of Topf 4-muffled double cremation furnaces” was intended for the Construction Inspection Office of Central Russia.⁴²²

This affair is quite typical. Above all, it allows us to see that as early as December 1941 Himmler had ordered the installation of crematorium furnaces in one camp, which was located in the occupied territories under military administration. It also shows that the highest SS authorities of the General Gouvernement and of the Soviet territories under military administration were interested in the installation of crematorium furnaces. Next, it proves that the SS work camp Trawniki, in which never more than 10,000 prisoners were interned, had several times requested the construction of a crematorium, but such a request was never made for Treblinka, Belżec, or Sobibór, where such a thing would have been much more necessary, provided the official history is correct. Finally, not even the SS Administrator at the Senior SS and Police Chief’s office in the General Gouvernement had ever ordered cremation furnaces for the three last-named camps, for he could have immediately received the 12 muffles that awaited their buyer in storage at the Topf firm.

Let us summarize: By December 1941, the problem of cremating corpses had emerged in the concentration and prisoner-of-war camps. Crematoria were built in Mogilev, in Majdanek, and in all the larger concentration camps, but not in the three allegedly pure extermination camps!

The SS paid the sum of 1,400,000 RM for the four crematoria of Birkenau,⁴²³ but for crematoria in the camps allegedly devoted exclusively to the extermination of Jews, the SS spent not a single penny, although exterminating the Jews is supposed to have been one of the main goals, if not *the* main goal, of NS policy!

Can anyone really take such nonsense seriously?

⁴²² Letter of the SS Administrator of June 2, 1943 to the *Bauinspektion* (Construction Inspection Office) of the Waffen-SS and Police Reich-East, RGVA, 502-1-314, pp. 36-36a.

⁴²³ Inventory of the building project of the war prisoner camp Auschwitz of October 28, 1942, VHA, Foundation OT 31 (2) 8; present value (2002) approximately \$12.5 million.

12. Cremation

a. Complexity of the Problem

The matter of the missing crematoria is all the more grotesque in that the problem of cremating the corpses would have been tremendous, if the official version of Treblinka corresponded to the facts. The American Jewish historian Konnilyn G. Feig comments the following in this regard:⁴²⁴

“The incredible complexity of the mass-grave problem frustrated the Germans. Their dismay was legitimate. Treblinka’s soil contained 700,000 bodies – a volume of 69,000 cubic meters weighing 35,000 tons, the same as a medium size battleship. Even if 1,000 bodies could be burned each day, 700 days would elapse before Himmler’s order had been obeyed.

Franz and Lalka [nickname of an SS officer] tried many approaches to the problem. They poured buckets of gasoline on the bodies in one ditch – producing huge flames and slightly singed corpses. They piled one hundred bodies into wide but shallow ditches, and dumped in gasoline again. The resulting fire did not destroy the corpses. They experimented with varying sizes of piles and quantities of gasoline – to no avail. At the end of the first testing period they concluded that Himmler’s request would take 140 years to fulfill.

As a second experiment, they built huge pyres – alternating bodies and wood and soaking the whole with gasoline. The fire destroyed the bodies but the test could not be repeated, for it was wartime and gasoline and tree trunks were not available in the quantities necessary to burn 700,000 corpses.”

Before we continue, we must correct the figures given here. If 700,000 bodies weighed 35,000 tons, then the average weight of a body was 50 kg and it occupied a volume of approximately 0.05 m³; thus, the entire volume was 35,000 m³ and not 69,000 m³.

In our calculations, we are assuming the number of bodies to be 870,000 as given by Arad and the *Encyclopedia of the Holocaust*, and assume the average weight to be 45 kg, since the corpses would have been buried for many months, leading to a loss of weight by desiccation. Thus, the total weight of the bodies would have amounted to 39,150,000 kg and the volume occupied by them would have been 39,150 m³.

Feig goes on to say:⁴²⁵

“Finally, the planners were forced to bring an expert, Herbert Floss. [...] Floss had the prisoners erect four cement pillars, 76 centimeters high, forming a rectangle 19 meters long and 1 meter wide. On top they laid

⁴²⁴ Konnilyn G. Feig, *Hitler’s Death Camps. The Sanity of Madness*, Holmes & Meier Publishers, New York-London 1981, pp. 306f.

⁴²⁵ *Ibid.*, p. 307.

railroad rails, and on the rails they piled several hundred bodies. Inmates called the two huge iron pyres 'Roasts'. A witness suggested that primitive grills could hold 2,600 bodies."

In order to increase the efficiency of the grates, Floss introduced an important innovation. As Jean-François Steiner, whom Feig quotes, claims, during his experiments Floss had discovered, in particular, that

"the old bodies burned better than the new ones, the fat ones better than the thin ones, the women better than the men, and the children not as well as the women but better than the men."

Therefore, "it was evident that the ideal body was the old body of a fat woman," and Floss had the bodies distributed according to these criteria.⁴²⁵

Feig is thus not embarrassed to repeat the crackpot claims of some witnesses that women's bodies burned spontaneously and served as fuel for the cremation of the rest of the bodies.⁴²⁶ Hardly less ridiculous is the claim that the bodies of old men burn better than those of young men. In actuality, the truth is exactly the opposite: in the bodies of men weakened by age the combustible materials – fats and proteins – are already partly used up by the process of aging.

But this is essentially a secondary issue. The main problem lies in the primitiveness of the burning technique. Can anyone in possession of his senses actually accept the scenario that the commandant of Treblinka, disregarding the experiences with cremation accumulated by the SS in Auschwitz, engaged in amateurish experiments while executing an order personally issued by Himmler himself, as though the cremation of 870,000 were a local problem, to be solved by makeshift methods?

No less abstruse is the notion that Himmler, who had at his disposal the best German engineers and technicians in the field of cremation – those of the firm of J.A. Topf & Söhne (Erfurt), Hans Kori (Berlin) and Didier Werke (Berlin), who had supplied the crematoria furnaces to all the German concentration camps – sent a nobody by the name of Herbert Floss to Treblinka!

b. Number and Structure of the Cremation Facilities

The technique of cremation employed in Treblinka was described as follows in the verdict of the Düsseldorf Court of Assizes at the trial of 1964-1965:⁴²⁷

"After the most diverse cremation attempts had been employed for this purpose, a large cremation facility was constructed. It consisted of a concrete base approximately 70 cm thick, upon which 5 to 6 railroad rails of perhaps 25 to 30 m length lay at small intervals. Under the rails burned a fire, while 2,000 to 3,000 of the bodies of the Jews killed in the gas chambers were loaded on the grate and then burned. When it was seen that this

⁴²⁶ For this see A. Neumaier, *op. cit.* (note 219), pp. 490-492.

⁴²⁷ A. Rückerl, *NS-Vernichtungslager...*, *op. cit.* (note 61), p. 205.

system worked, the corpses, which had been put into the body pits in the preceding months, were also retrieved, again with the help of a large excavator, and then likewise incinerated in the manner described."

According to the plan Jankiel Wiernik drew in 1945, as well as that presented at the trial in Düsseldorf,⁴²⁸ two such cremation facilities were in fact constructed. The cremation is supposed to have taken place between April and the end of July 1943,⁴²⁹ so that nearly all 860,000 bodies are supposed to have been incinerated within 122 days, *i.e.* 7,000 per day on two grates, or 3,500 per day per grate.

How large was such a grate? In the version of Wiernik's work *One Year in Treblinka*, published by A. Donat, one reads:⁴³⁰

"This is the way in which he^[431] got the Inferno started: He put into operation an excavator which could dig up 3,000 corpses at one time. A fire grate made from railroad tracks was placed on concrete foundations 100 to 150 meters in length. The workers piled the corpses on the grate and set them on fire."

The particulars given here are clearly the fruit of a later insertion, since the American English translation of Wiernik's 1944 account simply reads:⁴³²

"This is the way he got the hell started. He put a machine for exhuming the corpses into operation, which could, in one motion, dig up many, many dead bodies. A fire grate made of railway ties was laid out on cement foundations, and workmen had to pile the corpses on the grating and set them on fire."

If one takes into consideration the fact that 3,000 bodies take up a volume of about $(3,000 \times 0.045 =) 135 \text{ m}^3$, the claim, according to which the shovel of the excavator could be loaded with 3,000 bodies at a time, will evoke only amusement. The length of the grate (100 to 150 m) contradicts the trial documents. According to Arad, the grate was 30 m wide,⁴³³ but this too contradicts the verdict of the Düsseldorf Court of Assizes, according to which the grate consisted of "5 to 6 train rails of about 25 to 30 m in length." Since emaciated bodies, which easily disintegrated, were burned on both grates, the gap between two rails had to be small and could at most be permitted to amount to 50 to 60 cm, so that one can assume a width of the grate of approximately three meters. The width given by Feig – one meter – is obviously impossible.

⁴²⁸ See Documents 5 and 12 in the Appendix.

⁴²⁹ Y. Arad, *op. cit.* (note 71), p. 177. According to Arad, 7600 people were gassed and cremated in Treblinka in August 1943.

⁴³⁰ A. Donat, *op. cit.* (note 4), pp. 170f.

⁴³¹ An *Oberscharführer* not mentioned by name, who is probably supposed to be the phantom figure of Herbert Floss.

⁴³² J. Wiernik, *A Year in Treblinka*, *op. cit.* (note 164), p. 29.

⁴³³ Y. Arad, *op. cit.* (note 71), p. 174.

Thus, the two grates cannot have been larger than $30 \times 3 \times 0.76$ m each. As already explained, each grate must have burned 3,500 bodies every single day for 122 days. Let us now examine the consequences of this.

c. Arrangement of the Corpses on the Cremation Grates

The surface area of one grate amounted to 90 m^2 . In view of its structure, the bodies could only be placed crosswise on it; it is therefore to be assumed that for one meter of length of the grate – which corresponds to three square meters – four bodies can be placed, two respectively to the right and left of the central axis. We are assuming, however, for each body a theoretical average surface area of the size of a rectangle of $1.75 \text{ m} \times 0.50 \text{ m}$, which also includes the necessary intervening space for the passage of the products of combustion. On the entire grate, then, there is space for a layer of ($4 \times 30 =$) 120 bodies. If we start with a height of 30 cm per layer of bodies, and if one placed 3,500 bodies at the same time on the grate, the result would be ($3,500 \div 120 =$) 29 layers of bodies with a total height of ($29 \times 0.3 =$) 8.7 m!

According to the witness Henryk Reichmann, five to six grates were built, each of which was able to accommodate 2,500 bodies at a time.⁴³⁴ The witness Szyja Warszawski specified that each grate measured $10 \text{ m} \times 4 \text{ m}$.⁴³⁵ It follows from this that one could accommodate a layer of 46 bodies on each grate, and those 2,500 bodies – picture this – would result in 54 layers, or a hill of bodies 16 m high!

Even if the SS had managed the feat of piling up 29 or even 54 layers of bodies on the grate, the train rails would have bent under the load, as well as from the heat, and the body-mountain would have soon caved in.

d. Wood Requirement

The space available beneath the grate was ($0.76 \text{ m} \times 90 \text{ m}^2 =$) 68.4 m^3 . The weight of a cubic meter of normally stacked firewood lies between 340 and 450 kg. Let us assume the highest value here; then ($68.4 \times 450 =$) 30,780 kg of wood can fit in the 68.4 m^3 . Arnulf Neumaier refers to an article, which appeared in the November 27, 1986, *Schenectady* [New York] *Gazette*, according to which 6,433 tons of wood is required for the daily cremation of 21,000 bodies in India, which corresponds to a wood requirement of 306 kg per body.⁴³⁶ The author of the present chapter (Carlo Mattogno) has performed cremation experiments with animal flesh, which produced the following results:⁴³⁷

⁴³⁴ Statement of October 9, 1945, in: *Obóz straceń w Treblince, op. cit.* (note 38), pp. 31f.

⁴³⁵ *Ibid.*, p. 32.

⁴³⁶ Arnulf Neumaier, *op. cit.* (note 219), p. 495.

⁴³⁷ See C. Mattogno, "Combustion Experiments with Flesh and Animal Fat", *The Revisionist* 2(1) (2004), pp. 64-72.

- Quantity of wood needed for the cremation of one kilogram of animal flesh: 3.5 kg of seasoned wood (plus 0.1 liter of ethyl alcohol).
- Time required for the incineration of one kilogram of animal flesh: approximately 6 minutes.
- Amount of wood burned per square meter per one hour (until flames extinguish): approximately 80 kg.
- Wood ashes resulting: approximately 8% of the total weight.
- Specific gravity of wood ashes: approximately 0.34 g/cm³.

On the basis of this data one can calculate that the cremation of one body of 45 kg requires approximately 160 kg of seasoned wood. Consequently, in order to incinerate 3,500 bodies, (3,500×160=) 560,000 kg of wood is necessary, but there was room for merely 30,780 kg under the grate, therefore one seventh of that required. Therefore, no more than (30,780÷3,500=) 8.8 kg of wood would have been allotted to one body, a ridiculously insufficient amount.

Let us even suppose that it were feasible in some way or other to constantly pack new wood under the grate. In what period of time would the 560,000 kg of wood have been consumed by burning?

In fires with fixed grate and more natural ventilation, 150 to 190 kg of seasoned, chopped wood can be burned per square meter of grate per hour.⁴³⁸ But this applies only to an actual cremation apparatus with burning chamber, grate, a more adjustable air supply for burning, and chimney. With a pyre in the open, these values decline markedly. We therefore assume a sustainable value of 80 kg per square meter in our experiment.

This means that (90×80=) 7,200 kg of wood could be burned under the pile of bodies in one hour. In order to burn the 560,000 kg of wood necessary for incineration of the bodies, (560,000÷7,200=) approximately 78 hours is required, thus more than three days. If one adds the time needed for cooling down of the pyre, one cremation session can take place every five days. Therefore, the 122 cremation sessions of 7,000 bodies each – the prerequisite for the disposal of 860,000 bodies using two grates – requires a time period of (122×5=) 610 days.

The burning time computed here corresponds to (78÷29=) 2.5 hours per layer of bodies. In the case of a pyre with 29 layers of bodies, however, this time period is not sufficient, as a comparison with the crematorium furnace of the Gorini type shows: with this furnace from the nineteenth century, the body lay upon a grate, beneath which a wood fire of 100 to 150 kg burned. With this type of furnace, a cremation lasted from one-and-a-half to two hours.⁴³⁹

⁴³⁸ *Enciclopedia Curcio di Scienza e Tecnica*, Curcio Editore, Rome 1973, Vol. 5, p. 1916.

⁴³⁹ G. Pini, *La crémation en Italie et à l'étranger de 1774 à nos jours*, Ulrico Hoepli, Milan 1885, p. 151. In the Brunetti apparatus, in which the body lay on an iron sheet over a wood fire, the cremation process lasted six whole hours; *ibid.*, p. 132.

In the case of the pyre previously described, the flames and the products of combustion come in direct contact only with the layer of corpses lying directly on the grate and exert their effects upon any layer lying above that with an intensity quickly dwindling toward the vanishing point, so that a burning-time of 2.5 hours per level is totally unrealizable.

Therefore, had the cremation of 860,000 bodies in Treblinka been initiated at the beginning of April 1943, then under the most favorable conditions it would have ended in December 1945, and the Soviets as well as His Honor Judge Łukaszewicz would have been able to personally attend the performance!

e. Ashes

If we assume the value determined in our experiment of 160 kg of wood per 45 kg of organic substance, the quantity of wood necessary for the incineration of all bodies amounts to $(870,000 \times 160 =)$ 139,200,000 kg or 139,200 metric tons. The ashes from combustion resulting from this would have been $(139,200 \times 0.08 =)$ approximately 11,100 metric tons and occupied a volume of $(11,100 \div 0.34 =)$ approximately 32,600 m³.

The ashes resulting from cremation of a body weigh approximately 5% of the body weight and have a specific weight of approximately 0.5 g/cm³.⁴⁴⁰ Thus, from 870,000 bodies having an average weight of 45 kg, a mass of $(870,000 \times 45 \times 0.05 \div 1,000 =)$ approximately 1,950 tons of ashes results, which has a volume of $(1,950 \div 0.5 =)$ 3,900 m³. The total weight of the wood ashes and the ashes from incineration of the bodies therefore amounts to $(11,100 + 1,950 =)$ approximately 13,000 metric tons, which occupy a volume of $(32,600 + 3,900 =)$ 36,500 m³. To what location was this enormous quantity of ashes brought?

Arad writes:⁴⁴¹

“Ultimately it was decided to dump the ash and bits of bone into the ditches that had previously held the bodies and to cover them with a thick layer of sand and dirt. The ash was scattered in the pits in several layers, interspersed with layers of sand. The top 2 meters of the pit were filled with earth.”

As explained in Section 9, the excavated earth from the pits took up 130,700 m³ of space. Had the pits really been filled with ashes – a total of $(130,700 \text{ m}^3 + 36,500 \text{ m}^3 =)$ 167,200 m³ – then there would still remain $(167,200 - 118,800 =)$ approximately 48,400 m³ of earth-ash mixture, which could not have disappeared in smoke: where was this mass put? The claim of the Polish-Soviet

⁴⁴⁰ *Enciclopedia Italiana*, Rome 1949, under the entry “Cremazione,” Vol. XI, p. 5. Cf. also W. Huber, *Die Feuerbestattung – ein Postulat kultureller Entwicklung, und das St. Galler Krematorium*, self-published by the author. St. Gallen 1903, p. 17.

⁴⁴¹ Y. Arad, *op. cit.* (note 71), p. 176.

commission of September 1944, according to whom the single connecting road between Treblinka I and Treblinka II “was covered with cinders and ashes to a height of 7-10 cm,” would result in a maximum volume of $(3,000\text{m} \times 4\text{m} \times 0.1\text{m})^{442}$ 1,200 m³. But Łukasziewicz made no statement referring to this, and it would have been a rather stupid attempt to ‘eradicate’ the traces on the part of the SS men of Treblinka anyway. Finally, this claim contradicts even the witness testimony, according to which the ashes were poured into the mass graves *in toto*. Thus, for example, Wiernik writes:⁴⁴³

“It was our job to fill in the empty ditches with the ashes of the cremated victims, mixed with soil, in order to obliterate all traces of the mass graves.”

f. Wood Supply

Where did the administration of the Treblinka Camp obtain the 139,200 metric tons of wood required for the incineration of the bodies?

According to the witnesses, trees in the nearby forest were felled for the wood supply. The work was performed by a “*Holzfallerkommando*” (wood-felling unit).⁴⁴⁴ But the witness reports are extremely vague about the details, which one can well understand. During a period of 122 days, this party would have had to cut down, saw up and haul into the camp $(139,200 \div 122 =)$ 1,140 tons of wood *every day*! This means that every day it had to fell and saw up at least 760 trees and transport the load on 76 trucks carrying 15 metric tons each. This is decidedly too much, especially if one considers that this wood-felling party is supposed to have consisted, according to R. Glazar, of merely 25 men.⁸⁶

The environs of Treblinka are today overgrown with fir trees. A 50-year-old fir forest yields 496 tons of wood per hectare.⁴⁴⁵ For the sake of simplicity, we round this number to 500 tons. In order to obtain 139,200 tons of wood, the SS would therefore have had to cut down $(139,200 \div 500 =)$ 278.4 hectares of forest, which corresponds to 2.7 square kilometers! But such a large deforested zone would naturally have not gone unnoticed by the local Poles, who were questioned by Judge Łukasziewicz in his investigations. On the other hand, in the aerial photographs of May and November 1944 a thick forest of approximately 100 hectares can be recognized on the north and east side of the camp, of which at least one hectare is located on the camp area itself.⁴⁴⁶ The forest stretches beyond the Wólka Okrąglik-Treblinka road, and borders on it

⁴⁴² Length of the road: 3,000 m. Width of the road: 4 m. Depth of the layer: 0.10 m.

⁴⁴³ A. Donat, *op. cit.* (note 4), p. 181.

⁴⁴⁴ *Ibid.*, p. 97.

⁴⁴⁵ G. Colombo, *Manuale dell'ingegnere civile e industriale*, *op. cit.* (note 393), p. 161.

⁴⁴⁶ U. Walendy, “Der Fall Treblinka,” *op. cit.* (note 104), p. 33.

for over 2 kilometers. There is no trace of any area where trees have been felled.

The plan drawn by Jankiel Wiernik in 1945 shows a large forested zone in the northeast sector, not far from the two grates in the southeast sector. From whence came, then, the 139,200 tons of wood, the acquisition of which required approximately 92,800 trees?

g. Lack of Documentary Evidence for Cremations

These kinds of enormous pyres, had they actually existed, would obviously have been immediately conspicuous in the area surrounding Treblinka. In reference to this, the witness Kazimierz Skarzyński explained:⁴⁴⁷

“The bodies were piled on the rails and burned. The glow of the fire was visible at a distance of 15 km. During the day, black smoke spread. With a strong wind, the smell of burning was still perceptible 30 km away from the camp.”

As pointed out in our introduction, the Treblinka Camp was surrounded by quite a number of villages and hamlets. Within a radius of 10 km were the small towns of Wólka Ogrąalik, Poniatowo, Grady, Treblinka, Małkinia, Zawisty Dzikie, Rostki Wlk., Rytele, Świeckie, Olechny, Wszołki, Jakubiki, Tosie, Kosów Lacki, Dębe, Żochy, Rostki, Maliszewa, Guty, Bojewo, Brzózka, Kołodziaż, Orzełek, Złotki, Prostyń, Kielczew.

From every single one of these villages and hamlets one would have seen the glow of the flames from Treblinka for 122 days – how does it happen that there is no mention of this in any of the reports of the Polish resistance movement?

And how is it that Soviet reconnaissance planes discovered no trace of this gigantic cremation operation? Jankiel Wiernik supplies the following explanation for this:⁶²

“Whenever an airplane was sighted overhead, all work was stopped, the corpses were covered with foliage as camouflage against aerial observation.”

This, of course, is outrageous nonsense: in the first place, the planes would already have noticed the smoke from the grates long before they reached the camp, and in the second place, thanks to the great amount of smoke it would have produced, covering the grates with foliage would have been the best method to make them even more visible!

⁴⁴⁷ GARF, 7021-115-11, p. 16.

13. Witness Testimonies about Cremations

That such a mass cremation of many hundreds of thousands of bodies was not a real event follows, finally, from the glaring contradictions between the different eyewitness narratives.

As already mentioned, according to the official version of Treblinka ultimately agreed upon, there were supposedly two cremation grates of 30 m × 3 m in size, which were located on the grounds of the camp and which could each incinerate up to 3,500 bodies. However, in the original version, the witnesses placed the grates in the trenches. According to Szyja Warszawski, the cremation facility, which was incorrectly termed by him a “furnace,” was⁴⁴⁷

“[...] a pit 25 m in length, 20 m wide, and 5-6 m deep, with a grate out of rails on the bottom of the pit, which constituted an air vent.”

Abe Kon stated for the record:⁴⁴⁸

“[The bodies] were burned in a specially manufactured furnace, which could hold up to 6,000 bodies. The furnace was filled with bodies. These had gasoline and petroleum poured over them and were burned. The cremation lasted up to an hour.”

Apart from Abe Kon himself, the witnesses Hejnoch Brenner and Samuel Rajzman agreed on the following version:⁴⁴⁹

“The furnace – that was a large trench 200-300 m long and 5-6 m deep, excavated with an excavator. Three rows of reinforced concrete poles one-and-a-half meters high each were driven into the bottom of the trench. The poles were connected with one another by crossbeams. On these crossbeams were laid rails at intervals of 5 to 7 cm. This was a giant furnace grate. Narrow-gauge tracks were brought up to the edges of the trench.”

This variation was also adopted by Vassili Grossmann, who made his courtesy visit to Treblinka in September 1944 and was able to speak with the witnesses already questioned by the Soviets.⁴⁵⁰

But there would not have been room for such an enormous grate on the property of ‘Camp II’ of Treblinka II, whose longest side was only 188 m.

Subsequently, in the Polish investigative protocols, the grates migrated in wondrous fashion from out of the pits to the surface of the ground, and their dimensions shrank severely.

According to the witness Henryk Reichmann, five to six grates were installed, each of which was able to hold 2,500 bodies at a time.⁴⁵¹ Witness

⁴⁴⁸ Statement of August 1944, GARF, 7021-115-9, p. 33.

⁴⁴⁹ Report of August 24, 1944, GARF, 7021-115-9, p. 109.

⁴⁵⁰ W. Grossmann, *Treblinski Ad, op. cit.* (note 23), p. 191. Likewise the German version, *Die Hölle von Treblinka, op. cit.* (note 26), p. 33.

⁴⁵¹ Statement of December 1945, in: Z. Łukaszkiewicz, *Obóz straceń w Treblince, op. cit.* (note 38), pp. 31f.

Szyja Warszawski maintained that each grate measured 10 m × 4 m.⁴⁵² We have already underlined the fact that under these conditions 46 layers of bodies would have to have been piled on one grate; with 2,500 bodies, 54 layers, or a mountain of bodies 16 m high, would have been necessary!

Jankiel Wiernik writes that each grate – all were presumably located on the camp grounds – could burn 3,000 bodies at one time.⁴³⁰ The total capacity of all grates amounted, according to him, to 10,000 to 12,000 bodies.⁴⁵³ This obviously contradicts the camp plan drawn by the same witness, in which merely two grates are to be seen.⁴⁵⁴ At the end of July 1943 – once again according to Wiernik – 75% of the bodies from the mass graves are supposed to have been cremated, with 25% still remaining. Wiernik was not embarrassed to claim.⁴⁴³

“Within a few days work was begun to empty the remaining 25 per cent of the graves and the bodies were cremated.”

In view of the fact that on the 2nd of August, the day of the revolt, the cremation is already supposed to have been finished, this means that a quarter of the bodies must have been cremated within a maximum of ten days. Wiernik maintains silence about the exact number of victims of the camp, but speaks of “millions of people,”⁴⁵⁵ which corresponds to a minimum of two million; in the report of November 15, 1942, which he brazenly plagiarized, there was also mention of two million who had allegedly been exterminated in Treblinka up to then. According to his claims, therefore, in no more than ten days 500,000 bodies – a quarter of these two million – were transformed into ashes, although the grates could manage at most, according to his own statements, 12,000 bodies per day or 120,000 in ten days!

The idiocies served up by this witness are really beyond description. Wiernik gives every indication of being the author of the story of the spontaneous combustion of bodies, later continued by his cronies:⁶²

“It turned out that bodies of women burned more easily than those of men.

Accordingly, the bodies of women were used for kindling the fires.”

Let us remind ourselves once again that the entire story of Treblinka accepted today was promulgated by none other than Jankiel Wiernik!

14. Number Gassed Daily

In Chapter III, we have shown the official historiography’s unbelievable lack of capacity for critical judgment regarding the enormous technical problems, which exterminating the alleged number of Jews in Treblinka would have en-

⁴⁵² Statement of October 9, 1945, in: *ibid.*, p. 32.

⁴⁵³ A. Donat, *op. cit.* (note 4), p. 171.

⁴⁵⁴ See Chapter III.

⁴⁵⁵ A. Donat, *op. cit.* (note 4), p. 185.

tailed. Here the claims of the witnesses verge on pure insanity. For instance, Abe Kon had the nerve to make the following statement:⁴⁵⁶

“In this way, they exterminated 15,000 to 18,000 persons a day. It went on like that for two months.”

Stainslaw sings the same tune:⁴⁵⁷

“Within 13 months they killed 15,000 to 18,000 people there.”

At his interrogation of September 26, 1944, Samuel Rajzman stated:⁴⁵⁸

“Every day 5-6 transports with 60 boxcars each arrived in the camp. Of course, there were days on which 1-2 trains arrived, but that was an exception, not the rule. Six to seven thousand people arrived with each transport.”

This corresponds to 24,000, even 28,000, people daily! In 1946, Rajzman gave figures on the same order of magnitude:⁴⁵⁹

“Every day there were about 20,000 corpses. [...] There were days on which up to 25,000 people were killed.”

A further witness, Stanisław Borowy, testified that 12,000 to 18,000 deportees arrived daily in trains with 60 boxcars with 150 to 200 occupants each.⁴⁶⁰

Jankiel Wiernik wrote:⁴⁶¹

“Between ten and twelve thousand people were gassed each day. [...] There were periods when as many as 20,000 people were gassed in one day.”

Incredibly, these insanities were accepted by the court of a Western European nation as the unvarnished truth! In the verdict of the Düsseldorf Court of Assizes, ref. 8 I Ks 2/64, p. 88, one Manfred Blank declared:⁴⁶²

“In Treblinka many times up to 5 transports with an average of 6,000 people each arrived in one day.”

According to this, up to 30,000 people were reaching Treblinka daily! According to the transport lists provided by Arad, from July 22 to September 30, 1942, thus within a period of 70 days, approximately 500,000 Jews were deported to Treblinka and murdered there, although at that time only the first of the two gassing installations is supposed to have existed. This corresponds to a figure of more than 7,100 persons gassed per day! Since, according to the verdict of the abovementioned Düsseldorf trial, each of the three gas chambers

⁴⁵⁶ GARF, 7021-115-11, p. 33.

⁴⁵⁷ GARF, 7021-115-11, p. 35.

⁴⁵⁸ GARF, 7445-2-126, p. 240.

⁴⁵⁹ Wydawnictwo Centralnej Żydowskiej Komisji Historycznej (ed.), *Dokumenty i Materiały*, op. cit. (note 39), pp. 183, 186.

⁴⁶⁰ Statement of November 21, 1945, in: Z. Łukaszkiwicz, *Obóz straceń w Treblince*, op. cit. (note 38), p. 50.

⁴⁶¹ J. Wiernik, *A Year in Treblinka*, op. cit. (note 164), pp. 16, 21; A. Donat, op. cit. (note 4), pp. 159, 164.

⁴⁶² A. Ruckerl, *NS-Prozesse*, op. cit. (note 250), p. 38.

could hold a maximum of 350 persons, and thus the total capacity of the three chambers amounted to 1,050 persons, that would have meant no less than seven gassing operations per day per chamber, each of which is supposed to have taken less than three-and-a-half hours. According to the witnesses, however, the chambers were never in operation 24 hours a day, not even when 20,000 victims per day were coming in! In A. Donat's anthology, we read:⁴⁶³

"On such days the gas chambers were in operation until 1 a.m. and finished off more than 20,000 corpses within 24 hours."

The number of persons assumed by the Düsseldorf Court of Assizes to have been gassed at one time (21 to 22 people per square meter) is of course unrealistic and was only adopted because otherwise the astronomical number of people gassed given by the witnesses would never have been reached. Even the Soviets, famed as masters of exaggeration, assumed a density of no more than 6 persons per square meter in their calculation of the capacity of the rooms alleged to have been 'gas chambers' in the Majdanek Camp.⁴⁶⁴ Even if one assumes the highest density theoretically possible – 10 people per square meter – the three 'gas chambers' of the first installation would have been able to hold a maximum of 480 persons per process, so that 15 gassings would have been necessary to kill 7,100 people or more. Under these conditions, one gassing procedure, including all the accompanying steps, such as filling and emptying the chambers, would have had to have been completed in something over an hour and a half, and this would have to be done day in and day out for a period of 70 days!

This sort of thing should have been greeted with roars of contemptuous laughter, but Gerald Reitlinger and Jean-Claude Pressac are the only representatives of the official historiography who mustered the minimum of courage needed to reject this insult to ordinary common sense!

15. Property of Deportees as Material Evidence for their Extermination

J. Gumkowski and A. Rutkowski published two documents, which supposedly supply documentary evidence for the alleged mass extermination in Treblinka. These consist of a Wehrmacht bill of lading with the date "Treblinka, the 13th of September 1942," which references the dispatch of 50 train cars to Lublin with "articles of clothing of the Waffen-SS," and a Wehrmacht bill of lading with the date "Treblinka, the 10th of September 1943," which relates to the sending of a train car to Lublin with 5,200 kg of shoes.⁴⁶⁵ There is nothing in

⁴⁶³ A. Donat, *op. cit.* (note 4), p. 52.

⁴⁶⁴ J. Graf, C. Mattogno, *op. cit.* (note 270), p. 123.

⁴⁶⁵ J. Gumkowski, A. Rutkowski, *Treblinka, op. cit.* (note 77), reproductions of documents on

the documents themselves to indicate that this material was actually the property of deported Jews. This is particularly improbable in the case of the “articles of clothing of the Waffen-SS,” since the Waffen-SS had no relationship to the Treblinka Camp, and furthermore it is not clear what use the Waffen-SS would have for a collection of used civilian clothing. Perhaps the articles of clothing mentioned are simply Waffen-SS uniforms, which were being re-loaded on their return from the eastern front for the purpose of cleaning/delousing/sorting.

Samuel Rajzman furnished very exact information concerning the quantity of Jewish property taken by the Germans in another camp. He writes:⁴⁶⁶

“One of our organizers was the overseer of the detachment, in which 12-15 men were employed in the sorting of money and valuables, in determining the worth of objects of value and in packing them. In doing this, he had to submit a report to the Germans daily. He informed us about the weekly inventories. Approximately once a week we compared the entries of each worker. From October 1, 1942 - August 2, 1943, the following were transported to Germany:

25 railroad cars with women’s hair

248 cars of various clothing

100 cars of shoes

22 cars of textiles

46 cars of pharmaceutical and chemical preparations

4 cars of surgical and medical instruments

260 cars of blankets, pillows, carpets and traveling-rugs

400 cars with various objects (spectacles, gold fountain pens, fountain pens, combs, dishes, cases, umbrellas etc.).”

In a “classification of the quantity of used textiles delivered from the Lublin and Auschwitz camps by order of the Main Administrative Office of SS Economics unit,” which was appended as a supplement to a letter dated February 6, 1943, from the SS-Obergruppenführer Oswald Pohl, 825 cars are mentioned, which contained, among other things, the following:⁴⁶⁷

<i>“Rags</i>	<i>400 cars</i>	<i>2,700,000 kg</i>
<i>Bed feathers</i>	<i>130 cars</i>	<i>270,000 kg</i>
<i>women’s hair</i>	<i>1 car</i>	<i>3,000 kg</i>
<i>used material</i>	<i>5 cars</i>	<i>19,000 kg”</i>

Arad comments on this document:⁴⁶⁸

“This report relates to the textile materials transferred during 1942. That year the majority of deported Jews were sent to the death camps of Opera-

unnumbered pages.

⁴⁶⁶ USSR-337. GARF, 7445-2-126, pp. 243f.

⁴⁶⁷ NO-1257.

⁴⁶⁸ Y. Arad, *op. cit.* (note 71), p. 160.

tion Reinhard rather than to Auschwitz; therefore, these camps were the main source of the textiles mentioned in Pohl's report."

In order to convince his readers even further, Arad publishes a photograph, which shows an enormous pile of shoes and is deceptively captioned "A pile of shoes and boots in Belzec."⁴⁶⁹ In reality, the photo shows a barracks of the stored personal effects in Birkenau!⁴⁷⁰

Let us quickly examine:

a. Hair

Regarding the document mentioned above, Georges Wellers remarks:⁴⁷¹

"At the beginning of February 1943, a railway car with textile goods was sent from the Belzec camp to the Economics Ministry of the Reich (doc. no. 1257 and U.S.S.R. 511). The weight of the women's hair alone corresponds to the hair from 200,000 women."

Thus Wellers makes the same misleading statements about the point of origin of the car, as did Arad later on. Were his claim correct, then the hair of one woman would weigh 15 grams. The twenty-five cars mentioned by Rajzman would then have carried the hair of $(25 \times 3.000 / 0.015 =)$ five million women! But Wellers' assumption is erroneous, because the hair of male and female prisoners was continually recut in all German concentration camps for hygienic reasons. For example, on October 11, 1944, Anton Kaindl, commandant of the concentration camp Sachsenhausen, found it necessary to call the entire camp, particularly the infirmary building, to order because

"the hair-cutting in the camp, and also on the part of the infirmary, has not been performed according to regulations."

He therefore ordered "under threat of the harshest punishment":

"The hair of Reich German, Flemings, Dutch, Norwegians is to be cut to a length of 2 cm.

All members of the remaining nations are to receive close haircuts."

Kaindl complained in particular "that a large portion of the infirmary staff believes that they need not execute the orders of the camp" and reminded them that "this important war-economy camp regulation" was to be enforced "without a single exception." How large the quantity of cut hair was is evident from the last cargo, which weighed 275 kg.⁴⁷²

These 3,000 kg of hair, which was transported in the railway car mentioned above, therefore came from many haircuts given to prisoners at Auschwitz and Lublin in 1942.

⁴⁶⁹ *Ibid.*, p. 156.

⁴⁷⁰ *KL Auschwitz. Fotografie dokumentalne*, Krajowa Agencja Wydawnicza, Warsaw 1980, p. 267.

⁴⁷¹ G. Wellers, *La Solution finale et la mythomanie néo-nazie*, edited by Beate and Serge Klarsfeld, Paris 1979, p. 35.

⁴⁷² GARF, 7021-104-8, p. 1.

b. Shoes

The September 10, 1943, Wehrmacht bill of lading cited by Gumkowski and Rutkowski mentions the dispatch of a railway car with 5,200 kg of shoes of unknown origin to Lublin. To how many pairs does this correspond? If one assumes an average weight of 260 grams for each pair of shoes, then 5,200 kg amount to 20,000 pairs of shoes. If one had taken the shoes from all the Jews (allegedly) deported to Treblinka, then the 870,000 pairs of shoes would have had a weight of $(870,000 \times 0.260 =)$ 226,200 kg, and $(226,200 \div 5,200 =)$ 43.5 railway cars would have been required!

It is known that the Soviets found about 800,000 pairs of shoes in the Lublin/Majdanek Camp. The Polish historian Czesław Rajca, who is on the staff of the Majdanek Museum, wrote about this:⁴⁷³

“It was assumed that this [the quantity of shoes] came from prisoners killed in the camp. From documents, which later came to light, we know that in Majdanek there was a depot, to which shoes were sent from other camps.”

c. Articles of Clothing

As for the 50 railway cars with “articles of clothing of the Waffen-SS” mentioned in the Wehrmacht bill of lading dated “Treblinka, the 13th of September 1942,” they would have contained 337.5 metric tons of clothes altogether, or $6\frac{3}{4}$ in each boxcar, if we assume the same amount per railway car as listed above for the rags (2,700t/400). However, if each of the (allegedly) 870,000 Jews deported to Treblinka had worn or (along with extra clothing, pillows, and blankets) brought along 10 kg worth of article of clothing, and had these mountains of clothing been collected after the murder of the victims, then this would have amounted to 8,700 metric tons. For their transport nearly 1,300 railway cars would have been needed!

In comparison with this enormous amount, the railway cars with shoes of unknown origin and the 50 cars with Waffen-SS clothing, the existence of which is supported by documents, sound almost ridiculous. They furnish not the least bit of proof for a mass extermination in Treblinka.

In Lublin, incidentally, there were still other facilities for the collection and recycling of textiles. The most important of these were the “Lublin Fur and Clothing Workshops,” which took in clothing from various camps.

If the documents detailed above actually report on confiscated Jewish property, then they prove at most that the SS, within the framework of Operation Reinhardt, confiscated a small portion of Jewish belongings in Treblinka either arbitrarily or because the maximum permissible luggage weight was ex-

⁴⁷³ C. Rajca, *Problem liczby ofiar w obozie na Majdanku*, Tom XIV, Zeszyty Majdanek, Lublin 1992, p. 127.

ceeded. Moreover, there is no proof that at least a part of this material did *not* come from Treblinka I instead of from Treblinka II.

Finally, the list produced by S. Rajzman cannot be documented and is the product of pure fantasy.

Chapter V: Treblinka Trials

1. Confessions as a Basis for Historiography

In 1979, Gitta Sereny mounted a furious attack against revisionists, particularly against Arthur R. Butz. She made reference to her conversations conducted in 1971 with former Treblinka commandant Franz Stangl, who was incarcerated in a Düsseldorf jail and who, according to her claims, had admitted the mass murders in that camp; she wrote:⁴⁷⁴

“Stangl is dead. But if [...] Butz [...] actually had been interested in the truth, Stangl’s wife and many others would have been at his disposal to bear witness.”

Butz could have indicated in his response that Sereny was unable to prove what Stangl had actually said, due to the lack of a taped record, but he argued from an entirely different perspective:⁴⁷⁵

“We do not need ‘confessions’ or ‘trials’ to determine that the bombings of Dresden and Hiroshima, or the reprisals at Lidice following Heydrich’s assassination, really took place. Now, the extermination legend does not claim a few instances of homicide, but alleges events continental in geographical scope, of three years in temporal scope, and of several million in scope of victims. How ludicrous, then, is the position of the bearers of the legend, who in the last analysis will attempt to ‘prove’ such events on the basis of ‘confessions’ delivered under the fabric of hysteria, censorship, intimidation, persecution, and blatant illegality that has been shrouding this subject for 35 years. [...]”

[...] Sereny was arguing the reality of the colossal events alleged by reporting what a tired old man recently told her in prison. One might as well argue that the gypsies burned down New York City in 1950, on the basis of confessions of gypsies who were living there at the time. [...] She was taking a great deal of space in a prominent journal in presenting arguments that in 1979 were wildly incommensurate with the allegation in question. If

⁴⁷⁴ “The Men Who Whitewash Hitler,” *New Statesman*, November 2, 1979.

⁴⁷⁵ Butz’s reply to G. Sereny was not printed in the *New Statesman*. Its text can be found in the lecture given by Butz in 1982 at the conference of the Institute for Historical Review, which was published in a paper with the title “Context and Perspective in the Holocaust Controversy”, reprinted in A. R. Butz, *op. cit.* (note 108), pp. 401-431, here p. 404.

the Jews of Europe really had been exterminated, such arguments would not be offered.”

The indefensibility of an historical view that relies entirely on confessions from alleged perpetrators and eyewitness testimony could not have been better described! In what follows we will explain how the legal systems of the Federal Republic of Germany and of Israel have sought to strengthen the traditional image of Treblinka by means of trials, at which confessions by alleged offenders and eyewitness narratives comprised the sole basis of evidence.

2. West German Treblinka Trials

In a trial conducted in Düsseldorf from October 1964 to September 1965, ten persons, among them Kurt Franz, who was described as the last commandant of the camp,⁴⁷⁶ were charged with participation in the alleged mass killing of Jews in Treblinka. Four of the defendants, Franz among them, were sentenced to life imprisonment for the collective murder of 300,000 persons and for a number of individual murders; a fifth defendant received the same punishment for the collective murder of at least 100,000 people; prison sentences of twelve, seven, six, four, and three years were imposed on five others accused for assisting in the collective murder of 300,000 or 100,000 persons, respectively.

At a later Treblinka trial, which took place from May to December 1970, also in Düsseldorf, only one defendant appeared before the court, namely the former *SS-Hauptsturmführer* and second Treblinka commandant Franz Stangl. The latter was sentenced to life imprisonment for the murder, committed together with others, of at least 400,000 Jews, but he died in 1971 before the German Federal Supreme Court had ruled on his appeal.

At the first of these two proceedings more than 100, at the second over 50 witnesses were heard in and outside of Germany. Adalbert Rückerl, at that time director of the Ludwigsburg Central Office for the investigation of National Socialist crimes, documented these trials as well as those of the members of the camp staff of Bełżec, Sobibór, and Chełmno in his aforementioned

⁴⁷⁶ In a letter written on January 3, 1976, Kurt Franz, who continually protested his innocence, strongly denied having been camp commandant. He wrote:

“I served in Treblinka with the military rank of Oberscharführer of the Waffen-SS responsible exclusively only for the guard detachment and the men guarding the camp. An Oberscharführer is a Technical Sergeant and not an officer!”

The letter is printed in No. 44 of the *Historische Tatsachen* (note 104) on p. 23. Kurt Franz, who was charged with participation in the murder of 300,139 Jews, had lived in Düsseldorf under his own name up to 1959. (A. Rückerl, *NS-Vernichtungslager... , op. cit.* (note 61), pp. 44f.); therefore he obviously had a good conscience and it had never occurred to him that he could be accused of anything! Only in 1993 was he released, a gravely ill and broken man, after decades of imprisonment.

book *NS-Vernichtungslager im Spiegel deutscher Strafprozesse* (NS Extermination Camps as Reflected in German Criminal Trials), which was published in 1977. This book cites long passages from the verdicts. In his introduction to Rückerl's work, Martin Broszat, director of the Munich Institute for Contemporary History, wrote⁴⁷⁷

“Without wishing to anticipate an historical investigation and assessment of the role of the German justice system in the prosecution of NS crimes, so far one thing can be said to have resulted from it, and also from the activity of the Central Office [in Ludwigsburg]: the significance of the extensive prosecutorial and judicial investigations, which began in this area at the end of the 1950s in the Federal Republic [of Germany], cannot be measured only by their – often low – number of sentences. In regard to the investigations and proceedings dealing with mass killings of Jews [...] in particular, the systematic clearing up of the aggregate of crimes had a general public and historical relevance extending considerably beyond criminal prosecution. [...] Although the fact of the ‘Final Solution to the Jewish Question’ is noted in nearly all history and textbooks on the NS period, the individual modalities of this horrible event have scarcely been systematically documented until now. Their methodical concealment by the administrative departments of the regime and the thorough eradication of the traces after the conclusion of the operations, above all in the carefully hidden large extermination camps in the occupied Polish territories, have made it difficult or have hindered an exact reconstruction of the events. Despite an unfavorable point of departure, the years of painstaking work of judicial investigation have finally made the facts and context very clear.”

First of all, it ought to be stressed that Broszat's claim that “the large extermination camps in the occupied Polish territories” were “carefully hidden” is blatant nonsense. Auschwitz was situated in an industrial zone swarming with civilian workers, and the prisoners were in constant contact with them; Majdanek directly bordered on the city of Lublin, so that people were able to look into the camp from their houses at the edge of the city; in Treblinka, the farmers cultivated their fields nearly up to the camp fence, and the brisk trade between the prisoners and the civilian population described by former inmates, as noted above,⁴⁷⁸ guaranteed a steady flow of information from the camp to the outside world.

Let us move on to the “historical relevance” of the trials, as emphasized by Broszat. When he writes that the “individual modalities of this horrible event” have “scarcely been systematically documented up until now,” but that “years of painstaking work of judicial investigation have finally made the facts and

⁴⁷⁷ Adalbert Rückerl, *NS-Vernichtungslager...*, *op. cit.* (note 61), pp. 7f.

⁴⁷⁸ See Introduction.

context very clear,” this obviously means that until then historiography had *not* investigated the events in Treblinka and the other ‘pure extermination camps,’ but had left that task up to the courts.

Now, it is by no means the task of the judge to write history; his duty is to make a finding on the guilt or innocence of a defendant. The mission of the judge is therefore a fundamentally different one from that of the historian.

Yet whoever studies the ‘Holocaust’ literature very soon recognizes the decisive importance of court verdicts: for example, in the chapter devoted to the ‘extermination centers,’ in his three-volume ‘standard work’ *The Destruction of the European Jews*, R. Hilberg cites Adalbert Rückerl’s *NS-Vernehmungslager im Spiegel deutscher Strafprozesse* as a source no fewer than forty-one times.⁴⁷⁹ Under these circumstances, the actual purpose of the countless trials of the ‘Nazi criminals’ conducted in West Germany emerges quite clearly: they served to conjure up the desired evidence for million-fold murder in gas chambers on the basis of eyewitness narratives and confessions by alleged culprits, evidence, which historiography was unable to produce and has been unable to provide to the present day, for lack of documentary and material evidence. Hilberg and his consorts were then able to refer to the results of these criminal trials in their accounts of the ‘Holocaust.’

In view of the major political significance of the trials as outlined here, a former SS man sitting in the dock who hoped for the chance of an acquittal, or at least a lenient sentence, would of course dare not dispute the image of the concentration camp portrayed in the charges, but could only deny his own guilt or, if the witnesses had heavily incriminated him, claim that he had had to follow orders. Even if what Rückerl has written (on p. 25 of his *NS-Vernehmungslager*), that the defendants “without exception admitted their participation in the killing of Jewish men, women, and children, conducted on an industrial scale in the camps named,” were correct,⁴⁸⁰ this could easily be explained as having been done for opportunistic reasons: if an accused defendant did not do so, his conduct was interpreted as ‘obstinate denial’ and resulted in a harsher sentence. On the other hand, if a defendant went along with the prosecutors, he or she could hope for leniency, however terrible the charges against him might be.

An instructive example of this is furnished by a case mentioned by Rückerl: the former *SS-Hauptscharführer* Josef Oberhauser, stationed during the war in Bełżec, was put on trial in Munich in 1965. Although he was found guilty of assisting in the collective murder of 300,000 people during this trial,

⁴⁷⁹ With regard to this cf. Jürgen Graf, *op. cit.* (note 276), p. 89.

⁴⁸⁰ Kurt Franz, the main defendant at the trial of 1964-1965, repudiated any guilt on his own part, so that Rückerl’s claim, at least in Franz’s case, is invalid.

which lasted only four days, he nevertheless got away with the incredibly lenient sentence of merely four and a half years imprisonment.⁴⁸¹

“In the main proceedings, Oberhauser refused to testify. He referred to the necessity of following orders.”

This meant that he was not contesting the extermination of Jews in Bełżec; thus once again, the West German justice administration could triumphantly point out that the defendant had not in no way denied the mass murder. Since Oberhauser, as Ruckerl informs us,⁴⁸² had been taken into investigative custody in 1960, in 1965 his sentence was considered served and he was probably released shortly after the verdict was announced. Had he ‘obstinately denied’ the alleged crimes, he probably would have faced a life sentence!⁴⁸³

The witness testimony and confessions of defendants, the sole basis on which the West German justice administration could support its case in these trials, were accepted as ‘credible’ in all cases where they jibed with the charges. Thus, with regard to an ‘expert opinion’ from historian Helmut Krausnick, who had estimated the number of victims of the camp as at least 700,000, the verdict of the first Treblinka trial reads:⁴⁸⁴

“The Court of Assizes has no reservations in following the expert, who is well-known as a scholar due to his research into the National Socialist persecution of the Jews, since his expert opinion is detailed, thorough, and persuasive. This is all the more so when several defendants, among them the defendant S., who is gifted with an especially good memory, figured the number of victims at far more than 500,000. On what scale Treblinka operated, emerges from a characteristic description of the defendant S. concerning the opening of one of the body pits. As he plausibly tells, in the beginning of 1943, he once was in the upper camp just as one of the enormous body pits was being opened there, because the bodies now had to be burned.^[485] On this occasion, so S. relates, his comrade P., the deputy head of the death camp, explained that this one body pit alone contained approximately 80,000 dead. Since there were several body pits, and since the extermination operation by no means was ended in the beginning of 1943,

⁴⁸¹ Adalbert Ruckerl, *NS-Vernichtungslager...*, *op. cit.* (note 61), p. 86.

⁴⁸² *Ibid.*, p. 45.

⁴⁸³ Another striking example of the tactic, successfully employed by many defendants in NS trials, of purchasing a lenient sentence by confirming the picture of the extermination of Jews as described in the charges is furnished in the Frankfurt Auschwitz trial (1963-1965) by the defendant Robert Mulka. Such horrific atrocities were imputed to him that many objected to his sentence of 14 years imprisonment as inappropriate. Yet only four months later, Mulka was released without any fuss: G. Reitlinger, *op. cit.*, (note 180), p. 551.

⁴⁸⁴ A. Ruckerl, *NS-Vernichtungslager...*, *op. cit.* (note 61), p. 199; during the second West German Treblinka trial, the number of Treblinka victims mentioned by another expert report compiled by Wolfgang Scheffler rose to 900,000 “on the basis of new research”.

⁴⁸⁵ In the same verdict we read that the cremation of the bodies began “in the spring of 1943” (p. 205).

one can see in this description by S. nothing but a confirmation of the expert opinion, which assumes a minimum of 700,000 persons killed.”

What is to be thought of a judiciary that relies upon rumors and hearsay in a trial dealing with the murder of at least 700,000 – “S. relates that his comrade explained to him” – instead of proposing an investigation of the scene of the crime and suggesting to the Polish authorities that joint excavations to determine the size and position of the mass graves?

With what small mental endowment the Düsseldorf judges were graced may be seen from the following passage of their verdict:⁴⁸⁵

“The building, solidly constructed out of brick upon a concrete foundation, contained 3 gas chambers, which were approximately 4 × 4 m in area and about 2.6 m high. [...]

Very soon after the inception of operations, the capacity of the old gas house proved to be insufficient for smoothly liquidating the daily arriving transports of Jews. For that reason, at the end of August/beginning of September 1942, construction was started on a large new gas house, which contained more and larger gas chambers and was able to be put in operation after a construction period of about one month. [...] All are in agreement that the new gas chambers had a holding capacity approximately double that of the chambers in the old building. The new gas chambers were probably about 8 m long, 4 m wide, and 2 m high. [p. 203f.] How many people respectively were included in one gassing operation has not been determined with certainty in the main proceedings. [...] An accepted holding capacity of approximately 200 to 350 people per gas chamber in the old house and approximately 400 to 700 people per gas chamber in the new house might safely be said to be most probable according to all [information].” (p. 226)

Therefore, according to this eminent jurist, up to 22 people per square meter could have been crammed into the old as well as into the new gas chambers!

As to the number of the German and Ukrainian guards, the verdict says:⁴⁸⁶

“The camp staff in Treblinka, which was responsible for the smooth execution of the mass extermination, consisted of about 35 to 40 Germans who all wore the field-gray uniforms of the Waffen-SS and all of whom had the rank of at least SS-Unterscharführer. [...] Besides this group of German camp personnel there were about 90 to 120 Ukrainian volunteer auxiliaries, who mainly had to perform guard duties but were also used to a certain extent in the killing operations.”

These – at most – 40 Germans and 120 Ukrainians, according to the Düsseldorf Court, had to deal with up to 1,000 Jewish workers⁴⁸⁷ and thousands of Jewish deportees with every arriving transport:

⁴⁸⁶ *Ibid.*, pp. 206f.

⁴⁸⁷ *Ibid.*, p. 212.

“The accommodations of the Jewish workers, whose number was continually changing, but which on average might be put at between 500 and 1,000, were very primitive. [...]”

Not only did these up to 1,000 Jewish workers have to experience how the Germans and Ukrainians drove their co-religionists into the gas day after day, but they themselves always hovered on the brink of death:⁴⁸⁸

“At their work, the Jews were driven to hurry by insults and blows from a whip. [...] For the least cause but often without any sort of reason, Jewish workers in both parts of the camp were reviled, abused, slain, or shot day after day. It sufficed that a Jew, according to the notion of his overseer, was working too slowly or not carefully enough, for him to be whipped half-dead and subsequently to be shot in the infirmary.”

However, it never occurred to the Jewish workers (at least until August 2, 1943) to mount a resistance against their tormentors and murderers, who were far inferior to them in numbers!

The verdict has this to say concerning the measures taken to deceive the victims at their arrival:⁴⁸⁹

“In order to strengthen the impression in those arriving that Treblinka was merely a transfer station for further transportation to the east for work, large signs in German and Polish were posted on the platform or in its direct vicinity, the gist of which read: ‘Attention Warsaw Jews! You are in a transit camp here, from which there will be further transport to work camps. [...] For purposes of bodily hygiene, all those arriving must bathe before further transport.’

In addition – at least in the first period of the mass killings – a member of the German camp staff often addressed the people assembled at the train station square and explained the same thing which was on the signs.”

Exactly one page before quoting the above passage from this verdict, Rückerl cites the Jewish witness “Str.” as follows:⁴⁹⁰

“I then remember the terrible confusion when the doors were flung open in Treblinka. There were shouts from the Germans and Ukrainians, ‘get off, out.’ Even the members of the so-called Red Jewish Commandos shouted and yelled. Then the people arriving also began to yell and complain. I still remember that we were struck with whips. Then we were told: ‘Men to the right, women to the left and undress.’”

Naturally, under these circumstances a panic would have broken out immediately among the approximately 2,000 new arrivals⁴⁹¹ each time, and the 35 to

⁴⁸⁸ *Ibid.*, p. 214.

⁴⁸⁹ *Ibid.*, p. 219.

⁴⁹⁰ *Ibid.*, p. 218.

⁴⁹¹ Of the 50 to 60 railway cars, which each of the freight trains used in the deportations comprised, 20 at a time are supposed to have been unloaded, while the rest remained at the station (A. Rückerl, *NS-Vernichtungslager...*, *op. cit.* (note 61), p. 217). There was an average

40 Germans as well as the 90 to 120 Ukrainians would not have been able to prevent their running off in every direction. The measures of deception allegedly taken by the SS would have been entirely in vain. And why did the 500 to 1,000 Jewish workers never warn their doomed co-religionists?

No atrocity fairy tale from Jewish or Polish sources was too silly to be faithfully parroted by the Düsseldorf judges:⁴⁹²

“During the first weeks after the camp had started operations, the orchestra played lively operetta melodies near the hose in order to drown out the sound of the screams of the victims in the gas chambers.”

Since in every normal murder trial an expert opinion on the weapon used in the crime must be presented, and, if no body has been recovered, its absence must be explained, an unbiased observer would perhaps assume that the West German judiciary consulted a diesel engineer and an expert on cremation in order to learn whether the mass gassings and mass cremations described by the witnesses were technically feasible. But of all things, the Düsseldorf judges trotted out as an expert witness – a canine psychiatrist! From the original verdict of the first Treblinka trial:⁴⁹³

“Either at the end of 1942 or the beginning of 1943, the dog Barry was brought into the extermination camp Treblinka. This was a black-and-white spotted mixed-breed dog as large as a calf with predominantly the characteristic traits of a St. Bernard. In the camp he associated himself with the defendant Franz and regarded him as his master.

On his patrols through the upper and the lower camp, Franz was accustomed to having Barry with him most of the time. He always delighted in setting the dog on the prisoners who had drawn his attention in some way, with the words ‘man, catch the dog!’ [...] Barry always bit the targeted person indiscriminately. Since he was the size of a calf and the height of his shoulders – in contrast to smaller dogs – reached the buttocks and the abdomen of an average person, he frequently bit into the buttocks, into the abdomen, and several times into the genital area of male prisoners, which he even partially bit off in some cases. [...] When, during the absence of the defendant Franz, Barry was not under his influence, he was not the same dog. One could pet him and even tease him without him doing anything to anyone. [...]

As to the question of whether Barry was sometimes a vicious beast but at others a good-tempered and playful house pet, the Court of Assizes has heard under oath the Director of the Max Planck Institute for Behavioral Research in Seewiesen/Oberbayern, the internationally known researcher

of 100 deportees to a car.

⁴⁹² A. Rückerl, *NS-Vernichtungslager...*, *op. cit.* (note 61), p. 215.

⁴⁹³ *Ibid.*, pp. 234ff.

Professor Dr. L. In his persuasive expert report, Professor Dr. L. has stated, among other things, the following:

From the photographs of Barry shown to him by the Court of Assizes, he notes that this was not a purebred St. Bernard but a mixed-breed dog, which clearly predominantly showed the traits of a St. Bernard. Mixed-breed dogs are much more sensitive than purebred animals. If they have become attached to a master and have entered into a so-called dog-master bond, they would virtually anticipate their master's wishes; for a dog is 'the reflection of the subconscious of its master,' and that is especially true of mixed-breed dogs. [...] After the convincing exposition of Professor Dr. L., there therefore exists no logical contradiction between the findings that Barry on the one hand was dangerous when he was incited to attack Jews by Franz, and that on the other hand, during the absence of Franz, [...] he was indolent, good-tempered, and harmless on the camp property."

Adalbert Rückerl had this comment concerning these sagacious findings:⁴⁹⁴

"The [...] statements give an idea of what effort and care the judges expended in resolving individual details of the crime."

Gegen Dummheit kämpfen Götter selbst vergebens. (German proverb)

Even the Gods struggle in vain against stupidity.

3. The Demjanjuk Trial in Jerusalem

On April 25, 1988, John (Ivan) Demjanjuk, a Ukrainian extradited two years earlier from the United States to Israel, was sentenced to death by hanging in Jerusalem. The court, consisting of the judges Dov Levin, Zvi A. Tal, and Dalia Dorner, had found him guilty of the murder of several hundred thousand persons. He had been – so the verdict claimed – the sadistic Ukrainian guard who had been called ‘Ivan the Terrible’ and who had operated the gas chambers of Treblinka. But this wasn’t enough: according to the Israeli judges, Demjanjuk had hardly been satisfied with gassing the Jews, but tortured many of his victims beforehand in an outrageously bestial fashion. In its verdict, the Jerusalem court quoted the former Treblinka prisoner Pinchas Epstein, who ‘recognized’ his former tormentor in Demjanjuk during the trial, as follows:⁴⁹⁵

"I saw this man of vast proportions, well built, solid, and he was operating the motor, he was performing some action and pressing on something which activated the motor. After that, we would wait for twenty minutes to half an hour, and then they ordered the doors to be opened, these were

⁴⁹⁴ *Ibid.*, p. 234.

⁴⁹⁵ *Criminal Case No. 373/86, State of Israel vs. Ivan (John) Demjanjuk, Verdict*, pp. 180, 182f. We heartily thank Dr. Miroslav Dragan for having made this important document available to us.

very wide doors, and the corpses to be taken out. Ivan would come out of this room and would rain murderous blows on us with the pipe. Sometimes he would come with a dagger, sometimes with a bayonet, and he would crack skulls, he would cut off ears, he would brutalize the prisoners, it is absolutely unbelievable, unbelievable, and he would stand next to the corpses and gaze upon them. I want to say, honorable court, that it was horrible to look at the corpses when they took them out of the cabins. People with crushed faces, people with stab wounds, pregnant women with stab wounds in their bellies, women with the fetuses hanging half out, young girls with stab wounds on the breast, with eyes gouged out. [...] He would stand and gaze upon the results, what he had done, the stabbing of the girls, the gouging out of the eyes, the severing of the girls' breasts... he stood there like that, enjoying the scene... He was always near me, a few meters away. [...] And he would brutalize the prisoners, cut off a nose, injure somebody in the head, [...] Almost one million human beings, souls, were slaughtered, children, old people and little children. [...] Because they were Jews. This Ivan was a monster from another planet..."

The testimony of the witness Eliyahu Rosenberg, who likewise had identified Demjanjuk as the Satan of Treblinka, was recapitulated in the Jerusalem verdict as follows:⁴⁹⁶

"I saw him especially when I was working on the ramp every day, whenever consignments of Jews arrived for extermination. I saw him when he stood next to the gas chambers at the entrance to the corridor with a destructive instrument in his possession, such as a small short iron pipe, and a whip. He also wore a belt with his pistol. This shouldn't be so, all the destructive instruments together... I also saw that he had a dagger, I saw him with these destructive instruments, and how he would strike, lash, cut... these victims at the entrance to the gas chambers... [...] They knew how to strike, to strike. We were already there, at that place, and we got used to the beatings. But not to the tortures. God almighty, why tortures? Why cut living flesh from people? Nobody ordered them to do so, no one, he did it alone, on his own initiative. I never heard any German telling him to do that... [...]"

I was there on the ramp. We had removed the bodies from the gas chambers, Ivan came out of his cabin, he saw how I was standing there, the place was full of corpses, he said to me... lower your trousers... lay down on them... I saw this incident, and in a second I understood: this was it, I was finished, either by the pipe in his hand or in another manner. Lefler (one of the German S.S. men) was standing there. He was standing and looking. I ran to him, I stood to attention and said to him (in German): Ivan wants me to have sexual relations with a dead woman. So then he

⁴⁹⁶ *Ibid.*, pp. 184f.

went up to him and reprimanded him. Ivan only said to me (in Russian), I'll give it to you. He gave it to me and he found the opportunity."

Another witness, Yehiel Reichmann, testified as follows, according to the Jerusalem verdict:⁴⁹⁷

"I want to tell what took place next to the well with my friend Finkelstein. While I was still washing teeth together with him, with Finkelstein, this Ashmadai (devil) Ivan came with a drilling machine for drilling holes. And he rotated this drilling machine for making holes on Finkelstein's buttocks and said to him, if you scream I'll shoot you... He injured that Finkelstein, he was bleeding and suffering great pain, intense pain, but he was not permitted to scream, because Ivan had given him an order – 'If you scream, I'll shoot you'... Ivan was a super-devil, a super destroyer from Treblinka."

Thus went the witness testimony during a trial, which from the very beginning was intended to once again, more than four decades after the end of the war, graphically conjure up the horror of the 'Holocaust' before the eyes of the world in general and of the Israeli populace in particular. The trial had originally been planned to be conducted in a soccer stadium (!), but since its show-trial character would than have appeared all too evident, this notion was abandoned and a movie theater was chosen as the courtroom. The Israeli media relentlessly stoked the hysteria, and the trial was a mandatory topic in the nation's schools. But then things went much differently from the way they were planned: The trial became a colossal fiasco for the State of Israel and its judiciary.

The two most important books about the Demjanjuk trial are Hans Peter Rullmann's outstanding 1987 *Der Fall Demjanjuk. Unschuldiger oder Massenmörder?* (The Demjanjuk Case: Innocent Man or Mass Murderer?)⁴⁹⁸ and Yoram Sheftel's *Defending "Ivan the Terrible." The Conspiracy to Convict John Demjanjuk*. H. P. Rullmann, former Yugoslavia correspondent of the German left-wing news magazine *Der Spiegel* and chairman of the German-Croatian Society, throws light not only on the background and early stages of the Demjanjuk trial (the trial was still underway when the book appeared), but also goes into the historical context, in particular the tension-laden relations between Jews and Ukrainians; several times the author expresses doubts as to the correctness of the official version of Treblinka. On the other hand, the Israeli attorney Y. Sheftel, Demjanjuk's defense counsel, by his own admission an ardent Zionist, accepts this version without reservation and insists merely on the personal innocence of his client, who has been the victim of a conspiracy. Thanks to the committed efforts of Sheftel, the death sentence was

⁴⁹⁷ *Ibid.*, p. 186.

⁴⁹⁸ Yoram Sheftel, *Defending "Ivan the Terrible." The Conspiracy to Convict John Demjanjuk*, Regnery Publishing, Washington 1996.

quashed by the Israeli Appeals Court, and Demjanjuk was able to return to the USA after seven years of innocent imprisonment.

In the following account of the Demjanjuk case, we are relying for the most part on Rullmann's documentation for events before 1987, the year his book was published; for the following period, we rely upon the Sheftel book.

Ivan Demjanjuk, born in 1920 in the Ukraine, fell into German hands as a soldier of the Red Army in 1942. He was at first employed in the repair of railroad tracks, and then was sent to the prisoner of war camp of Chełm in eastern Poland, where he was held until the beginning of 1944. In order to escape the hunger in the camp, he put himself at the disposal of the Germans as an auxiliary volunteer and was assigned to a Ukrainian National Guard unit under General Shandruk, which fought side by side with the Wehrmacht against the Soviets. In 1945, Demjanjuk escaped the fate of many of his countrymen, who were delivered by the British to the Bolsheviks, then shipped off to the camps of the Gulag Archipelago. After living for a few years in Germany, where he married a Ukrainian woman, he emigrated to the U.S. in 1952, and made a life for himself there as an auto worker, receiving citizenship in 1958.

The fact that Demjanjuk was active in the Ukrainian community in his new residence of Cleveland, Ohio, spelled disaster for him. A certain Michael Hanusiak, staff member of the Communist newspaper *Ukrainian News*, published one article after another, in which the anti-Communist Ukrainian exiles supporting the independence of their homeland were smeared as 'Nazi collaborators.' According to Hanusiak, seventy of these sinister figures were living in Cleveland. In 1975, Demjanjuk came into the crosshairs of the *Ukrainian News*. Hanusiak claims that he had found the testimony of a certain Danilchenko in a Soviet archive, according to which the latter had gotten to know an Ivan Demjanjuk in Sobibór in March 1943. There – according to Danilchenko – that Demjanjuk had driven Jewish prisoners into the gas chambers as an executioner's assistant of the Germans; in the spring of the same year, he was allegedly sent, together with Danilchenko, to the Flossenbürg concentration camp, where he again was employed as a guard.

Now the battue against the autoworker could begin. The Cleveland newspaper *Plain Dealer* identified him as 'Ivan the Terrible,' and starting in 1976, U.S. immigration authorities sought information against him. They requested the Jewish World Congress to find former Sobibór inmates who could incriminate the suspect. There were no prosecution witnesses, and the mysterious Danilchenko himself had vanished without a trace. In a search for witnesses, a U.S. investigative group traveled to Israel, where seven former Treblinka prisoners 'recognized' Demjanjuk as the evil Ivan of Treblinka on the basis of a photograph. These statements of course contradicted Danilchenko's information, according to which the Ukrainian had not been in Treblinka but in Sobibór and Flossenbürg, but the ball was already rolling.

Next the Moscow-directed *Ukrainian News* published an incriminating ‘document’ in facsimile; once again the Soviet information was clearly not reconcilable with the testimony of the seven Israeli witnesses. The document was allegedly Demjanjuk’s service ID card from the training camp Trawniki, where many Ukrainians had been trained as concentration camp guards during the war. According to this ID card, Demjanjuk had been detailed to Sobibór on March 27, 1943; Treblinka was not mentioned on it. The document was an obvious and clumsy forgery, for it displayed neither a date of issue nor an expiration date. (In mid-1987 it was subjected to a chemical analysis by the McCrone Institute in the USA, which proved that titanium oxide was a component of the photographic paper – a chemical used in black-and-white photography only since the end of the sixties.⁴⁹⁹) The ‘original document’ was made available to the Israeli justice administration by the Soviets at the end of 1986, ten months after Demjanjuk’s extradition.

Up to that point US immigration authorities had only the facsimile of the ID card as evidence, which in any case offered no evidence of Demjanjuk’s presence in Treblinka; yet the document was accepted as conclusive. Demjanjuk was deprived of his U.S. citizenship and in February 1986, under breach of constitutional principles, was extradited to Israel, a nation, which did not even exist at the time of the alleged mass murders in Treblinka. A substantial role in this scandalous violation of law was played by the ‘Nazi-hunting’ OSI, established under President Jimmy Carter and for many years led by a Jewish lawyer, Neil Sher,⁵⁰⁰ which specialized – using perjured testimony and forged documents – in stripping innocent old men of German or eastern European descent of their U.S. citizenship and deporting or extraditing them to prosecuting nations.⁵⁰¹

One year after this, the Jerusalem trial began, and five former Jewish Treblinka prisoners who claimed that they saw the accused in that camp in 1942/1943 recited their unspeakable tales of horror to the best of their ability. An obviously embarrassing detail was that one of these witnesses, Eliyahu Rosenberg, had in 1947 in Vienna stated the following:⁵⁰²

⁴⁹⁹ Cf. also the analysis by Dieter Lehner, *Du sollst nicht falsch Zeugnis geben*, Berg, n.d. [1988].

⁵⁰⁰ In 2003, the District of Columbia Court of Appeals ordered Sher disbarred from the Bar Association of the District of Columbia for misappropriating funds earmarked for Holocaust survivors; cf. *Forward*, September 5, 2003; editor’s remark.

⁵⁰¹ Through the example of one case (the prosecution of Martin Bartesch), Andrew Allen documents the murky machinations of the OSI in “Die US-Nazijäger vom OSI und der Holocaust-Mythos”, *Vierteljahreshfte für freie Geschichtsforschung*, 5(4) (2001), pp. 428-430; English online: *idem*, “The Office of Special Investigations and the Holocaust Myth,” <https://codoh.com/library/document/the-office-of-special-investigations-and-the/>.

⁵⁰² This explanation of Rosenberg has been reproduced in full by H. P. Rullmann, *op. cit.* (note 187), on pp. 133f.

“The second of August 1943 was set as the day of the revolt. [...] About three-thirty in the afternoon everything was prepared for the revolt. [...] Then one of the water-carriers right then dashed into the barracks and yelled: ‘Revolution in Berlin.’ This was the signal. Thereupon some people rushed into the barracks of the Ukrainian guard detachment, where among others also the Ukrainian Ivan was sleeping, and killed the Ukrainians with shovels.”

During the trial, however, Rosenberg offered the excuse that he was only repeating what he had heard and had not actually witnessed the death of Ivan.

In April 1988, as everyone had expected, the Jerusalem Court passed the death sentence but it was not carried out. By then all too many embarrassing mistakes had occurred, and defense counsel Sheftel (who had acid sprayed in his face by a criminal at the end of 1988, a few days after a second Demjanjuk attorney, Dov Eitan, had fallen to his death from a high-rise building) thoroughly exploited these errors in his appeal. Finally, Sheftel pointed to one Ivan Marchenko – missing without a trace – as the actual Ivan the Terrible.

This name had first been mentioned by a former prostitute living in the hamlet of Treblinka, who had numbered among her clientele several Ukrainian guards from the camp during the war, among them Marchenko, but Sheftel soon found more evidence of him in the USSR. According to Soviet court documents, a Ukrainian by the name of Nikolai Shelaiev, who had been condemned to death and shot in 1952 due to alleged crimes in Treblinka, had identified this Ivan Marchenko as operator of the gas chambers of Treblinka. Shelaiev’s testimony was confirmed by several other former Treblinka guards, and a personal ID card of Marchenko from Trawniki also came to light.

The Israeli judiciary now had to grit its teeth and concede that Demjanjuk, despite all the oaths of the five eyewitnesses, had not been ‘Ivan the Terrible’, but first undertook yet another weak attempt to charge him with crimes, this time in Sobibór and Flossenbürg. But there were no witnesses to such crimes, and according to the Israeli-American extradition treaty Demjanjuk could not be tried for offenses in these two camps, since his extradition had been predicated solely on his alleged atrocities in Treblinka. Thus he was finally able to return to the United States in September of 1993. To date this innocent man has not received a single dollar of compensation for the shameful injustice done to him. On the contrary: his persecution began anew in February 2002, this time for his alleged service in the camps Sobibór, Majdanek, and Flossenbürg.⁵⁰³

⁵⁰³ In that month, Demjanjuk was once more deprived of American citizenship on the initiative of the U.S. government; cf. “In Kürze”, *Vierteljahreshefte für freie Geschichtsforschung*, 6(2) (2002), p. 239.

As do so many legends, that of ‘Ivan the Terrible’ may contain a kernel of truth: presumably a brutal Ukrainian guard feared by the prisoners, who was called Ivan or the like, did serve in Treblinka. All else is pure fantasy.

The Demjanjuk trial, in which all five Jewish ‘eyewitnesses’ proved to be perjured liars and swindlers, dealt a frightful blow to the credibility of such witnesses. In fact, since that trial no more ‘gas chamber witnesses’ have dared to testify in court.

Part 2:
The Function of Treblinka:
An Alternative Interpretation

Chapter VI: National Socialist Policy of Jewish Emigration

1. Emigration

From the time Adolf Hitler assumed power, the National Socialist policy toward the Jews aimed consistently at their ‘removal’ from Germany.⁵⁰⁴

On August 28, 1933, the Reich Economics Ministry concluded the so-called ‘Haavara Agreement’ with the Jewish Agency for Palestine, an economic accord that was intended to lay the basis for the emigration of approximately 52,000 German Jews to Palestine by the year 1942.⁵⁰⁵ Until the outbreak of the Second World War and indeed even for some time afterward – as long as circumstances permitted – the emigration of Jews to all nations prepared to accept them was the leitmotif of the National Socialist policy. This is confirmed by a report of the Foreign Ministry of January 25, 1939, which bore the title: “*Die Judenfrage als Faktor der Außenpolitik im Jahre 1938*” (The Jewish question as a factor of foreign policy in 1938):⁵⁰⁶

“The final goal of German policy regarding the Jews is the emigration of all Jews living in the territory of the Reich.”

On the previous day, the 24th of January 1939, Hermann Göring had issued a decree, which approved the establishment of a ‘Reich Central Office for Jewish Emigration.’ Reinhardt Heydrich was put in charge of it. In the first line, Göring summarized the basic principle of the NS policy vis-à-vis the Jews:

“The emigration of the Jews out of Germany is to be promoted by all means.”

The Reich Central Office had the mission of “effecting all measures for the preparation of an intensified emigration of the Jews,” of promoting preferen-

⁵⁰⁴ Hitler had already expressed this intention in the first written document of his political career, a letter to his friend Gemlich on September 16, 1919 (a), and later in his speech “Warum sind wir Antisemiten?” (b).

a) E. Deuerlein, “Hitlers Eintritt in die Politik und die Reichswehr”, in: *Vierteljahrshefte für Zeitgeschichte*, 1959, p. 204.

b) R. H. Phelps, “Hitler’s ‘grundlegende’ Rede über den Antisemitismus” in: *Vierteljahrshefte für Zeitgeschichte*, 1968, p. 417.

⁵⁰⁵ R. Vogel, *Ein Stempel hat gefehlt. Dokumente zur Emigration deutscher Juden*, Droemer Knaur, Munich/Zürich 1977, pp. 46 and 107-109.

⁵⁰⁶ PS-3358.

tial emigration of poor Jews and, lastly, of facilitating bureaucratic procedure for individuals.⁵⁰⁷

On June 24, 1940, Heydrich asked Foreign Minister Joachim Ribbentrop to inform him of possible ministerial meetings regarding the ‘final solution of the Jewish question.’ The German wording of this phrase, upon which so much print has been expended and about which so much disinformation has been propagated, is “*Endlösung der Judenfrage.*” Heydrich gave these reasons for his request:⁵⁰⁸

“The Herr General Field Marshall, in his capacity as delegate for the Four Year Plan, charged me in the year 1939 with the execution of Jewish emigration from the entire territory of the Reich. In the period that followed we have managed, despite great difficulties even during the war, in successfully continuing the Jewish emigration.

Since my administrative office assumed the task on January 1, 1939, more than 200,000 Jews have emigrated from the territory of the Reich. The whole problem – there are already approximately 3¼ million Jews in the territories subject to German sovereignty today – can, however, no longer be solved by emigration.

A territorial final solution is thus becoming necessary.”

As a result of this letter, the Foreign Ministry devised the so-called Madagascar Plan. On July 3, 1940, Franz Rademacher, director of the Jewish Department in the Foreign Ministry, composed a report entitled “Die Judenfrage im Friedensvertrage” (The Jewish Question in the Peace Treaty), which begins with the following declaration:

“The approaching victory gives Germany the possibility and, in my opinion, also the duty of solving the Jewish problem in Europe. The most desirable solution of all is: all Jews out of Europe.”

Rademacher explained that by the peace treaty – regarded as imminent – with France, Germany would receive the island of Madagascar as a mandate, to which all European Jews would be deported and which would form an autonomous state under the control of Germany.⁵⁰⁹

“The island will be transferred to Germany as a mandate. [...] Other than that, the Jews receive self-government in this territory: their own mayors, their own police, their own post office and rail administration etc. The Jews will be liable as co-debtors for the value of the whole island.”

The project was approved by Ribbentrop and was referred to the *Reichssicherheitshauptamt*, which was to be responsible for the technical preparations for

⁵⁰⁷ NG-2586-A.

⁵⁰⁸ T-173.

⁵⁰⁹ NG-2586-B.

the resettlement of the Jews to the east African island and the supervision of the evacuated Jews.⁵¹⁰

This, then, was the “territorial final solution” of the Jewish question that Heydrich had in mind.

2. The Madagascar Plan⁵¹¹

On August 30, 1940, Rademacher prepared the note “*Madagaskar-Projekt*,” in which the section “*Finanzierung*” (Financing) begins with the following words:⁵¹²

“The execution of the proposed final solution requires substantial means.”

The ‘final solution of the Jewish question’ therefore meant nothing other than the resettlement of the European Jews to Madagascar. On July 12, 1940, Hans Frank, Governor General of Poland, gave a speech, in which he announced the decision⁵¹³

“to deport the entire Jewish tribe in the German Reich, in the General Gouvernement, and in the Protectorate within the shortest time imaginable after the conclusion of peace to an African or American colony. Madagascar, which is supposed to be ceded by France for this purpose, is under consideration.”

On July 25, Frank repeated that the Führer had decided to deport the Jews,⁵¹⁴

“as soon as the overseas traffic permits the possibility of the transportation of the Jews.”

In October 1940, Alfred Rosenberg wrote an article entitled “*Juden auf Madagaskar*” (Jews to Madagascar), in which he recalled that as early as the anti-Jewish Congress of Budapest in 1927

“[...] the question of a future forced evacuation of the Jews out of Europe [was] discussed, and there for the first time surfaced the proposal of promoting Madagascar as the future home of the Jews.”

Rosenberg took up the proposal and expressed his wish that “Jewish high-finance” of the USA and Great Britain might also contribute to the establishment of a ‘Jewish reservation’ on Madagascar, which in his opinion constituted “a world problem.”⁵¹⁵

⁵¹⁰ NG-2586-J.

⁵¹¹ A detailed complete study of this question is Magnus Brechtken’s “*Madagaskar für die Juden*”: *Antisemitische Idee und politische Praxis 1895-1945*, R. Oldenbourg Verlag, Munich 1998.

⁵¹² NG-2586-D.

⁵¹³ PS-2233. IMT, Vol. XXIX, p. 378.

⁵¹⁴ PS-2233. IMT, Vol. XXIX, p. 405.

⁵¹⁵ CDJC, CXLVI-51, pp. 4, 7, 9.

At the conference, the theme of which was “The Jewish Question as World Problem,” which took place on March 29, 1941, Rosenberg declared:

“For Germany, the Jewish issue will be solved only when the last Jew has departed the territory of greater Germany.”

He mentioned in this connection a “Jewish reservation,” which – even though Rosenberg did not expressly say it – was obviously supposed to be located on Madagascar.⁵¹⁶

According to the testimony of Moritz von Schirmeister, a former official in the Propaganda Ministry, Josef Goebbels spoke about the Madagascar Plan several times,⁵¹⁷ and Ribbentrop recalled the decision of the Führer to deport the European Jews to north Africa or Madagascar.⁵¹⁸ This was no idle pipe dream, but rather a very real and concrete project. Parallel to this, the authorities of the Reich kept promoting Jewish emigration, mainly out of Germany, by all means.

On May 20, 1941, in expectation of the implementation of the Madagascar Plan, which, so it was thought, was imminent, Heydrich prohibited Jewish emigration from France and Belgium “in view of the final solution of the Jewish problem, which is undoubtedly approaching.”⁵¹⁹ But Heydrich nevertheless repeated the central principle of the NS policy toward the Jews:⁵²⁰

“In accordance with a communication from the Reichsmarschall of the Greater German Reich [Göring], the emigration of the Jews from the territory of the Reich, including the Protectorate of Bohemia and Moravia, is to be carried out and even intensified during the war within the limits of the existing possibilities in compliance with the guidelines established for the emigration of the Jews.”

Heydrich then unambiguously explained the reasons for the prohibition of Jewish emigration from France and Belgium:⁵¹⁹

“Since there exist, for example, only insufficient travel possibilities for the Jews out of the Reich territory, chiefly across Spain and Portugal, an emigration of Jews from France and Belgium would mean a renewed decrease of the same.”

Two months after that, on July 31, Göring entrusted Heydrich with the mission to effect all necessary preparations for the ‘final solution,’ *i.e.* the emigration or evacuation of all Jews in the German sphere of influence, to Madagascar. In his letter we read:⁵²¹

⁵¹⁶ CDJC, CXLVI-23, pp. 6 and 82.

⁵¹⁷ IMT, Vol. XVII, pp. 250.

⁵¹⁸ IMT, Vol. X, p. 398.

⁵¹⁹ NG-3104.

⁵²⁰ NG-2586-E. PS-710.

⁵²¹ The legal emigration into other states or the deportation to the east (Poland: October 1939 to March 1940) or to the West (unoccupied France: October 1940).

“Supplementary to the task already delegated to you with the order of Jan. 14, '39, of bringing the Jewish problem to the most favorable solution consistent with the circumstances and in the form of the emigration or evacuation, I hereby charge you to effect all necessary organizational, practical, and material preparations for a total solution of the Jewish question within the German sphere of influence in Europe. Insofar as the responsibilities of other central authorities are involved in this, they are to participate.

I further charge you to present me shortly with a comprehensive plan for the organizational, practical, and material prerequisites for the execution of our goal, the final solution of the Jewish question.”

This document is in full conformity with the Madagascar Plan. The instructions from Göring issued as “[s]upplementary” to those already given to Heydrich in the order of January 14, 1939, in fact consisted exclusively in the accomplishment of the solution of the Jewish problem “in the form of emigration or evacuation”⁵²² of the Jews from the Reich, while at the same time a territorial ‘final solution’ for all Jews in the German-occupied European nations, by means of forced resettlement to Madagascar, was the aim. Precisely because it included all Jews of the occupied European nations, this solution was designated as the “*Gesamtlösung*” (complete solution).

By virtue of the fact that Heydrich wrote on November 6, 1941, that he had already been charged for years with the preparation for the ‘final solution’ in Europe,⁵²³ he himself was clearly referring to the task assigned to him by the order of January 14, 1939, and identified the ‘final solution’ with the “solution in form of an emigration or evacuation,” which Göring had specified as the goal in the letter of July 31, 1941. In the same context belongs an order, which was transmitted to the Foreign Office by Adolf Eichmann on August 28, 1941, and which prohibited “an emigration of Jews out of the territories occupied by us, in consideration of the final solution of the issue of European Jews, which is in preparation and is approaching.”⁵²⁴

3. From Madagascar Plan to Deportation to the East

In the following months, after the start of the Russian campaign, the prospect of large territorial gains became realistic so that new perspectives developed, which led to a significant change of course in the NS Jewish policy. In place of the ‘final solution’ by forced resettlement to Madagascar, a ‘territorial final solution’ emerged, by which the European Jews were to be deported to the eastern territories conquered by the Germans.

⁵²² PS-1624.

⁵²³ PA, Inland II A/B, AZ 83-85 Sdh. 4, Bd. 59/3.

⁵²⁴ CDJC, V-15.

This change in course was announced on August 22, 1941, by SS-Sturm-bannführer Carltheo Zeitschel, an advisor at the German embassy in Paris, who wrote a note to the attention of ambassador Otto Abetz.⁵²⁵

“The progressive conquest and occupation of the far eastern territories can presently bring the Jewish problem in all of Europe to a final satisfactory solution within a very short time. As is seen from the cries for assistance by all the Jews of Palestine in their press to the American Jews, over 6 million Jews reside in the territories occupied by us during the last weeks, especially Bessarabia – that is, one-third of World Jewry. During the new organization of the eastern lands, these 6 million Jews would have to be collected anyhow and a special territory presumably marked off for them. It shouldn’t be too big a problem, at this opportunity, if the Jews from all the other European countries are added to this and the Jews presently crammed into ghettos in Warsaw, Litzmannstadt, Lublin, etc. are also deported there.

Regarding the occupied territories, such as Holland, Belgium, Luxemburg, Norway, Yugoslavia, Greece, the Jews can simply be transported by military order in mass-transports into the new territory, and it can be suggested to the remaining states that they follow this example and get rid of their Jews by sending them to this territory. We could then have Europe free of Jews within a very short time.

The idea, which has recurred for years and which was aired once again by Admiral Darlan a few months ago, of transporting all the Jews of Europe to Madagascar, is, to be sure, not bad in itself, but would run up against insurmountable transportation difficulties directly after the war, since world tonnage, seriously decimated by the war, will surely be needed for other things more important than taking large numbers of Jews for a ride on the oceans of the world. Not to mention that transportation of nearly 10 million would require years, even if there were numerous ships available.

For this reason, I propose to present this question to the Reich Foreign Ministry at the next opportunity, and to ask to meet for discussion with the aforementioned future minister for the eastern territories, Reichsleiter Rosenberg, and with the Reichsführer-SS with such a regulation in mind and to examine the matter in the manner I have suggested. The problem of transporting the Jews to the eastern territories could even be dealt with during the war and would not encounter insurmountable difficulties after the war, especially since all the Jews in the General Gouvernement would be able to cover the distance into the newly delineated territory, of course, with their automobiles on country roads.”

After Zeitschel had alluded to the situation of French Jewry, he concluded:

⁵²⁵ PS-1017.

“Furthermore, I would propose suggesting this idea at the next opportunity to the Reichsmarschall as well; he is currently quite receptive to the Jewish problem and, given his present attitude and his experiences, could surely be an extraordinarily strong supporter in the execution of the idea developed above.”

The plan of deporting the Jews into the eastern territories had already been considered several times earlier. On April 2, 1941, even before the start of the eastern campaign, Reichsminister Rosenberg had toyed with the thought⁵²⁶

“of making use to a greater extent of Muscovite Russia as a disposal region for undesirable elements of the population.”

On July 17, 1941, General Governor Frank made the following entry in his work diary:⁵²⁷

“The Herr Governor General wants no further ghetto formation, since according to an express declaration of the Führer of June 19 of this year, the Jews would be removed from the General Gouvernement within a foreseeable time, and the General Gouvernement is supposed to be only a sort of transit camp.”

On August 20, 1941, after a visit to the headquarters of the Führer, Goebbels confided the following to his diary:⁵²⁸

“Beyond this, however, the Führer has promised me that I can deport the Jews out of Berlin into the east directly after the end of the eastern campaign. [...]”

On September 24, 1941, Goebbels had a conversation with Heydrich in the Führer’s headquarters; on the day after, he wrote in his diary that the Jews in the east

*“in the end are all supposed to be transported [...] into the camps built by the Bolsheviks.”*⁵²⁸

Likewise, on September 28, he wrote that the Führer held the view that one must push the Jews step by step out of all of Germany, and he expressed the following desire:⁵²⁸

“Berlin is first in line, and it is my hope that we succeed during the course of this year in transporting a substantial part of the Berlin Jews to the east.”

In a note of October 7, 1941, Werner Koeppen, a liaison of Rosenberg’s, wrote that on the previous day Hitler had declared the following on the Protectorate:⁵²⁸

“All Jews must be removed from the Protectorate, and indeed not just into the General Gouvernement, but farther on to the east. The great need for

⁵²⁶ Citation by Martin Broszat, “Hitler und die Genesis der “Endlösung.” Aus Anlaß der Thesen von David Irving”, in: *Vierteljahrshefte für Zeitgeschichte*, No. 25/4, 1977, pp. 748f.

⁵²⁷ *Ibid.*, p. 750.

⁵²⁸ *Ibid.*, p. 751.

means of transportation is the only reason why this cannot be executed at the moment. Along with the Protectorate Jews, all Jews should disappear from Berlin and Vienna at the same time."

On October 13, 1941, Frank and Rosenberg had a conversation, during which they discussed the deportation of the Jews from the General Gouvernement:⁵²⁹

"The Governor General then came to speak about the possibility of deporting the Jewish population of the General Gouvernement into the occupied territories of the east. Reichsminister Rosenberg remarked that similar requests were already being brought to him from the military administration in Paris.^[530] At the moment, however, he saw no possibility as yet for the carrying out of these kinds of resettlement plans. But he announced himself ready to promote the emigration of Jews to the east in the future, especially since the intention existed anyhow of sending off asocial elements within the territory of the Reich into the sparsely settled territories of the east."

Zeitschel's proposal was thus accepted some months later by Hitler himself, who resolved to temporarily shelve the Madagascar Plan and to deport all Jews living in the occupied territories to the east. This decision of the Führer was probably made in September 1941. On October 23, 1941, Himmler prohibited Jewish emigration, effective at once,⁵³¹ and on the following day the evacuation of 50,000 western Jews to the east was ordered. On October 24, Kurt Daluge, chief of the *Ordnungspolizei* (the regular police force responsible for keeping public order), issued a decree that dealt with "Evacuations of Jews from the Old Reich and the Protectorate":⁵³²

"In the period from November 1 to December 4, 1941, 50,000 Jews will be deported by the Sicherheitspolizei [Security Police] from the Old Reich, the Ostmark [Austria] and the Protectorate of Bohemia and Moravia to the east, into the region around Riga and Minsk. The evacuations will take place in transport trains of the Reichsbahn [German railway] for 1,000 persons at a time. The transport trains will assemble in Berlin, Hamburg, Hanover, Dortmund, Münster, Düsseldorf, Cologne, Frankfurt/M., Kassel, Stuttgart, Nuremberg, Munich, Vienna, Breslau, Prague, and Brünn [Brno]."

On October 25, 1941, Franz Rademacher, legation counselor at the Foreign Office, composed a note, in which, after recording the shooting of 8,000 male Jews in Serbia, he added the following:⁵³³

⁵²⁹ *Faschismus – Getto – Massenmord*, op. cit. (note 289), p. 252.

⁵³⁰ A clear allusion to the proposal of *SS-Sturmbannführer* Carltheo Zeitschel.

⁵³¹ T-394: "The Reichsführer-SS and Chief of the German Police has ordered that the emigration of Jews is to be prohibited effective immediately."

⁵³² PS-3921.

⁵³³ Robert Kempner, *Eichmann und Komplizen*, Europe Verlag, Zürich-Stuttgart-Vienna 1961, p. 293.

“The rest of the approximately 20,000 Jews (women, children, and old people) and about 1,500 Gypsies, whose men were likewise also shot,^[534] were to be collected into the so-called Gypsy Quarter of the city of Belgrade as a ghetto. Food for the winter could be secured in scanty amounts. [...]

As soon as the technical possibility exists within the scope of the total solution of the Jewish question, the Jews will be deported by sea to the reception camps in the east.”

If, according to this, a portion of these Serbian Jews (the adult males) were shot and the rest were subject to the “total solution to the Jewish problem,” it is clear that the physical destruction of the Jews could not have been meant by the latter phrase, but merely the deportation into “reception camps in the east,” which served to accept Jews incapable of working.

The new course of the NS policy toward the Jews was officially announced to the senior party ranks at the Wannsee Conference, called expressly for this purpose. The conference, originally planned for December 9, 1941,⁵³⁵ but then postponed, took place on January 20, 1942, at Großer Wannsee 56/58 in Berlin. The speaker was Reinhardt Heydrich. The conference protocol begins with a broad retrospective on the National Socialist Jewish policy up to that point.⁵³⁶

“At the beginning of the discussion Chief of the Security Police and of the SD [Sicherheitsdienst = Security Service], SS-Obergruppenführer Heydrich, reported that the Reichsmarschall had appointed him delegate for the preparation of the final solution of the Jewish question in Europe and pointed out that this discussion had been called for the purpose of clarifying fundamental questions. The wish of the Reich Marshal to have a draft sent to him concerning organizational, practical and material interests in relation to the final solution of the Jewish question in Europe necessitates the initial joint action of all central offices immediately concerned with these questions in order to bring their general activities into line. The Reichsführer-SS and the Chief of the German Police (Chief of the Security

⁵³⁴ The male Jews were supposed to have been deported, since they had taken part in “numerous acts of sabotage and revolt.” At first it was intended to deport them “to the General Gouvernement or Russia,” but because “difficulties with transportation” intervened and the Germans rated these Jews as a direct security threat, they were shot. *ibid.*, pp. 288-292.

⁵³⁵ PS-709.

⁵³⁶ NG-2586-G. It should be pointed out that there is well-founded doubt as to the authenticity of the Wannsee Protocol, cf. Roland Bohlinger, Johannes P. Ney, *Zur Frage der Echtheit des Wannsee-Protokolls*, 2nd ed., Verlag für ganzheitliche Forschung und Kultur, Viöl 1994; Roland Bohlinger (ed.), *Die Stellungnahme der Leitung der Gedenkstätte Haus der Wannsee-Konferenz zu dem von Bohlinger und Ney verfaßten Gutachten zur Frage der Echtheit des sogenannten Wannsee-Protokolls und der dazugehörigen Schriftstücke*, Verlag für ganzheitliche Forschung, Viöl 1995; J. P. Ney, “Das Wannsee-Protokoll – Anatomie einer Fälschung”, in: E. Gauss (ed.), *op. cit.* (note 97), pp. 169-191.

Police and the SD) was entrusted with the official central handling of the final solution of the Jewish question without regard to geographic borders. The Chief of the Security Police and the SD then gave a short report of the struggle which has been carried on thus far against this enemy, the essential points being the following:

a/ the expulsion of the Jews from every sphere of life of the German people, b/ the expulsion of the Jews from the living space of the German people.

In carrying out these efforts, an increased and planned acceleration of the emigration of the Jews from Reich territory was started, as the only possible present solution.

By order of the Reich Marshal, a Reich Central Office for Jewish Emigration was set up in January 1939 and the Chief of the Security Police and SD was entrusted with its management. Its most important tasks were:

a/ to make all necessary arrangements for the preparation for an increased emigration of the Jews,

b/ to direct the flow of emigration,

c/ to speed the procedure of emigration in each individual case.

The aim of all this was to cleanse German living space of Jews in a legal manner.”

Heydrich emphasized that as a result of this policy and despite various difficulties, up to October 31, 1941, approximately 537,000 Jews had emigrated:

- approximately 360,000 from the Old Reich, borders of January 30, 1933.
- approximately 147,000 from the Ostmark, borders of March 15, 1938.
- approximately 30,000 from the Protectorate of Bohemia and Moravia, borders of March 15, 1939.

The protocol continues:

“In the meantime the Reichsführer-SS and Chief of the German Police had prohibited emigration of Jews due to the dangers of an emigration in wartime and due to the possibilities of the east.

Another possible solution of the problem has now taken the place of emigration, i.e. the evacuation of the Jews to the East, provided that the Führer gives the appropriate approval in advance.

These actions are, however, only to be considered provisional, but practical experience is already being collected, which is of the greatest importance in relation to the future final solution of the Jewish question.”

Thus, on Hitler’s order, the deportation of Jews into the occupied territories of the east replaced the emigration or expulsion of all European Jews to Madagascar, though merely as a “provisional” solution pending a ‘final solution’ of this issue after the war’s end.

In August 1940, Hitler announced his intention to evacuate all the Jews of Europe after the war.⁵³⁷ According to a note of the Reich Chancellery from

⁵³⁷ Memorandum of Luther for Rademacher of August 15, 1940, in: *Documents on German*

March or April 1942, he had repeatedly informed Lammers, the chief of this Chancellery, “that he wanted to defer the solution of the Jewish problem until after the war.”⁵³⁸ On July 24, 1942, the Führer confirmed this intention with pithy words:⁵³⁹

“After finishing the war he will take the rigorous position that he will crush city after city, if the Jews would not come out and migrate to Madagascar or some other Jewish national state.”

The intention of the National Socialists to deal with the solution of the Jewish problem after the war is also apparent from the so-called ‘Brown Portfolio,’ which was outlined by Rosenberg on June 20, 1941, and integrated into the ‘Green Portfolio’ of September 1942. There, the section “*Richtlinien für die Behandlung der Judenfrage*” (Guidelines for the handling of the Jewish question) begins with the following words:⁵⁴⁰

“All measures for the Jewish problem in the occupied eastern territories must be executed from the perspective that the Jewish problem will be solved for all of Europe in general after the war. For this reason they are to be applied as preparatory partial measures and must be in harmony with the decisions otherwise affecting this area. On the other hand, the experiences gained in the handling of the Jewish question in the occupied eastern territories can point the way to the solution of the whole problem, since the Jews in these regions, together with the Jews of the General Gouvernement, comprise the strongest contingent of European Jewry. Measures, which are of a purely harassing nature, are to be refrained from under any circumstances as being unworthy of a German.”

In a copy of these “Guidelines for the Handling of the Jewish Problem,” which bears no date but which nevertheless certainly comes from this period, an additional sentence was inserted after the sentence ending with “decisions otherwise affecting this area”:⁵⁴¹

“This applies with particular urgency to the creation of at least temporary possibilities for the reception of Jews from the Reich territory.”

In connection with Jews of Spanish nationality residing in occupied France, a note by Luther of October 17, 1941, likewise mentions

*“measures to be taken after the war’s end for the fundamental solution of the Jewish question.”*⁵⁴²

Foreign Policy 1918-1945, Her Majesty’s Stationery Office, Series D, Vol. X, London 1957, p. 484.

⁵³⁸ PS-4025.

⁵³⁹ Henry Picker, *Hitler’s Tischgespräche im Führerhauptquartier*, Wilhelm Goldmann Verlag, Munich 1981, p. 456.

⁵⁴⁰ “Richtlinien für die Führung der Wirtschaft in den besetzten Ostgebieten” (Grüne Mappe), Berlin, September 1942. EC-347. IMT, Vol. XXXVI, p. 348.

⁵⁴¹ PS-212. IMT, Vol. XXV, p. 302.

⁵⁴² PA, Politische Abteilung III 245, AZ Po 36, Bd. I.

Therefore, the Wannsee Conference had been called for the sole purpose of announcing to the authorities concerned the shelving of the emigration policy and the Madagascar Plan as well as the start of a policy of extensive deportation of Jews to the east and the discussion of the problems thereby generated. The Madagascar Plan was officially abandoned on February 10, 1942. A letter from Rademacher to Bielfeld, a diplomat in the Foreign Ministry, dated February 10, 1942, explains why:⁵⁴³

“In August 1940, I passed on to you for your files the plan devised by my department for the final solution of the Jewish question, for which the island of Madagascar was supposed to be demanded from France in the peace treaty, but the practical execution of the task was to be handed over to the Reichssicherheitshauptamt. In accordance with this plan, Gruppenführer Heydrich was put charged by the Führer with carrying out the solution to the Jewish problem in Europe.

In the meantime, the war against the Soviet Union has provided the possibility of making other territories available for the final solution. The Führer has consequently decided that the Jews will not be deported to Madagascar, but to the east instead. Thus, Madagascar no longer needs to be designated for the final solution.”

The ‘final solution’ was therefore of a territorial nature and consisted of the deportation of the Jews from territories governed by Germany to the east. This is fully consistent with another important document, the Luther Memorandum of August 1942. In it Luther above all summarized the essential points of the NS policy with respect to the Jews:⁵⁴⁴

“The basis of the German Jewish policy after the [first world] war, after the assumption of power, consisted of promoting Jewish emigration by every means. For this purpose a Reich Central Office for Jewish Emigration was created in the year 1939 by General Field Marshall Göring in his capacity as delegate for the Four Year Plan, and the administration was handed over to Gruppenführer Heydrich as Chief of the Security Police.”

After he had explained the genesis and development of the Madagascar Plan, which in the meantime had been overtaken by events, Luther stressed that Göring’s letter of July 31, 1941, resulted from Heydrich’s letter of June 24, 1940, according to which the Jewish question was no longer to be solved by emigration, but required “a territorial final solution.” Luther continues:

“After this realization, Reich Marshal Göring charged Gruppenführer Heydrich on July 31, 1941, to make all necessary preparations for a complete solution of the Jewish question in the German sphere of influence in Europe with the participation of the German central authorities involved in the issue. [...] On the basis of this directive, Gruppenführer Heydrich ar-

⁵⁴³ NG-5770.

⁵⁴⁴ NG-2586-J.

ranged a meeting on January 20, 1942, of all participating German administrative departments, which the secretaries of state of the remaining ministries and I myself, from the Foreign Office, had attended. At the meeting, Gruppenführer Heydrich explained that the Reich Marshal had ordered him by the directive of the Führer, and that the Führer had now approved the evacuation of the Jews to the east instead of emigration.”

On the basis of this order, Luther added, the evacuation of the Jews from Germany had been implemented. Their destination was the eastern territories, to which they would be deported via the General Gouvernement:

“The transportation to the General Gouvernement is a temporary measure. The Jews will be transported onward to the eastern territories as soon as the technical prerequisites for this are in place.”

A circular of October 9, 1942, entitled “Rumors concerning the situation of the Jews in the east,” intended for party functionaries, explains the measures taken against the Jews as follows:⁵⁴⁵

“In the course of the work on the final solution of the Jewish question, discussions concerning ‘very harsh measures’ taken against the Jews, particularly in the eastern territories, are currently arising amongst the population in various parts of the Reich territory. It has been determined that such accounts – mostly in distorted and exaggerated form – are being passed on by those on leave from various units employed in the east, who themselves have had occasion to observe such measures.

It is conceivable that not all fellow countrymen are able to muster adequate understanding for the necessity of such measures, especially not that part of the populace, which has had no opportunity to form its own opinion of the Bolshevik atrocities.

In order to be able to counter any creation of rumors in this connection, which frequently bears an intentionally tendentious character, the exposition set out below is given for instruction about the present situation:

For approximately 2,000 years, a struggle has been fought against Jewry, which has so far been in vain. It is only since 1933 have we started to seek ways and means, which permit a complete separation of Jewry from the body of the German people. The work toward the solution accomplished to date can basically be subdivided as follows:

- 1. Expulsion of the Jews from various areas of life of the German people. Here, the laws enacted by the legislators should form a foundation, which also offers the guarantee of protecting future generations from a possible new inundation by the enemy.*
- 2. The aim of completely expelling the enemy from the territory of the Reich. Considering the highly limited living-space available to the German*

⁵⁴⁵ PS-3244.

people, it was hoped that this problem would be essentially solved through acceleration of emigration of the Jews.

Since the beginning of the war in 1939, these possibilities for emigration have become increasingly reduced; on the other hand, the economic domain of the German people steadily increased in comparison with its living-space, so that today, considering the large number of the Jews residing in these territories, a complete expulsion by means of emigration is no longer possible. Since our next generation will no longer see this problem as realistically and, on the basis of past experiences, will no longer see it clearly enough, and because the matter, once it has started rolling, makes a settlement urgent, the whole problem must be solved by the present generation.

For that reason, the complete expulsion or separation of the millions of Jews residing in the European economic domain is a compelling commandment in the struggle to secure the existence of the German people.

Beginning with the territory of the Reich and leading to the rest of the European nations included in the final solution, the Jews will be continuously transported to the east into large camps, some existing, some still to be constructed, from whence they will either be put to work or be taken still farther to the east. The old Jews, as well as the Jews with high war decorations (Iron Cross, First Class; Golden Medal for Bravery etc.) will continue to be resettled in the city of Theresienstadt located in the Protectorate of Bohemia and Moravia.

It lies in the nature of things that these in part very difficult problems can be solved only with ruthless severity in the interests of the ultimate security of our people."

In a report entitled "Financing the Measures for the Solution of the Jewish Problem" of December 14, 1942, Ministerial Counselor Maedel summed up the National Socialist policy toward the Jews as follows:⁵⁴⁶

"The Reich Marshal charged the Reichsführer-SS and Chief of the German Police a long time ago with preparing the measures, which will serve the final solution of the European Jewish question. The Reichsführer-SS has entrusted the execution of these tasks to the Chief of the Security Police and of the SD. Initially, the latter promoted the legal emigration of the Jews overseas by special measures. When, on the outbreak of the war, the emigration overseas was no longer possible, he initiated the gradual clearing of the Reich territory of Jews by their deportation to the east. Moreover, in more recent times old peoples' homes (old peoples' ghettos) have been established within Reich territory for the admission of Jews, e.g. in Theresienstadt. Indications as to the particulars are found in the note of

⁵⁴⁶ NG-4583.

August 21, 1942. The establishment of additional old peoples' homes in the eastern territories is imminent."

4. Results of the NS Policy of Promoting Jewish Emigration

The National Socialist policy for the promotion of Jewish emigration conformed to a concrete goal of the Reich leadership and was accordingly carried out earnestly and successfully. In April of 1943, Richard Korherr, Inspector for Statistics at the office of the Reichsführer SS, wrote a report entitled "The Final Solution to the European Jewish Question,"⁵⁴⁷ in which the following figures are given:

Region	Start of Period ending Dec. 31, 1942	Emigration	Mortality Surplus
Altreich (Germany proper, with Sudetenland)	January 31, 1933 (Sept. 29, 1938)	-382,534	-61,193
Ostmark (Austria)	March 13, 1938	-149,124	-14,509
Bohemia and Moravia	March 16, 1939	-25,699	-7,074
Eastern Territories (with Białystok)	September 1939 (June 1940)	-334,673	
General Gouvernement (Po- land, with Lemberg)	September 1939 (June 1940)	-427,920	
Combined Total		-1,402,726	

Thus, 557,357 Jews emigrated from the Altreich (Germany proper), Austria, and Bohemia and Moravia, to which more than half of the 762,593 Jews from the General Gouvernement and the eastern territories can be added,⁵⁴⁸ a figure from the categories "Emigration" and "Mortality Surplus" combined by Korherr for those two areas. Consequently, the NS government stimulated the emigration of approximately one million Jews out of the territories controlled by it from 1933 to 1942.

⁵⁴⁷ NO-5193.

⁵⁴⁸ Approximately 300,000 Jews emigrated from Poland alone in 1939-1941. G. Reitlinger, *op. cit.* (note 180), p. 542.

5. The Start of Deportation of Jews to the East

The policy of deportation of Jews to the east, which was decided upon by Hitler himself in September 1941, received its official blessing in a letter, which Himmler wrote to Gauleiter Arthur Greiser on September 18, 1941:⁵⁴⁹

“The Führer desires that the Altreich [Germany proper] and the Protectorate be emptied and freed of Jews as soon as possible, from the west to the east. It is therefore my intention, if possible this year, to initially transport the Jews from the Altreich and the Protectorate into the eastern territories newly incorporated into the Reich two years ago, as a first stage, in order to deport them still farther to the east next spring.

I am planning to bring about 60,000 Jews of the Altreich and the Protectorate into the Litzmannstadt Ghetto for the winter, which, as I understand, has space to accept them. In the interests of the Reich as a whole, I am asking you not only to understand, but to exert all your powers in supporting this measure, which surely will cause difficulties for your district.

SS-Gruppenführer Heydrich, who has the task of carrying out this migration of Jews, will be turning to you in due course, directly or through SS-Gruppenführer Koppe.”

At a meeting held in Prague on October 10, 1941, in which Heydrich also took part, the solution of the Jewish problem in the Protectorate as well as the partial solution of the Jewish problem in the Altreich was discussed. The start of the deportations was fixed for October 15, and it was decided to deport 50,000 Jews to Minsk and Riga:⁵⁵⁰

“It was planned to begin with it on October 15, 1941, in order to get the transports started gradually until November 15, up to an amount of about 5,000 Jews – from Prague only. For the time being, much consideration must still be shown to the Litzmannstadt authorities. Minsk and Riga are supposed to get 50,000.”

In regard to the accommodation of the future deportees, we read:

“SS-Brif. [Brigadeführer] Nebe and Rasch can take Jews into the camps for Communist prisoners in the zone of operations.”

As already mentioned, the deportation order was issued on October 24, 1941. The eastern territories were the destination of these deportations. At that time, the eastern territories under civilian administration were the *Reichskommissariat Ostland* and the *Reichskommissariat Ukraine*, both subject to the authority of Alfred Rosenberg, the Reichsminister for the occupied territo-

⁵⁴⁹ Himmler letter to Greiser of 18 September 1941, Bundesarchiv Koblenz, NS 19/2655, p. 3. Reproduction of the document in Peter Witte, “Zwei Entscheidungen in der ‘Endlösung der Judenfrage’: Deportationen nach Lodz und Vernichtung in Chelmno” in: *Theresienstädter Studien und Dokumente*, Verlag Academia, Prague 1995, p. 50.

⁵⁵⁰ T-37/299.

ries of the east. The *Reichskommissariat Ostland*, administered by *Reichskommissar* Hinrich Lohse, was subdivided into the four general districts or *Generalkommissariate* of Estonia, Latvia, Lithuania, and White Russia, while the *Reichskommissariat* Ukraine was governed by *Reichskommissar* Erich Koch.

The first orders with respect to the Jews in the eastern territories were harsh, but in no way aimed at extermination. The paragraph “Guidelines for the handling of the Jewish question” in the ‘Brown Portfolio’ dating from June 20, 1941, intended the isolation of the local Jews from the rest of the population and their exclusion from economic, social, and cultural life by means of ghettoization.⁵⁵¹

“Freedom of movement is immediately abolished for all Jews. A transfer to ghettos is intended, which is facilitated in White Russia and in the Ukraine by the presence of numerous more or less closed Jewish settlements. A Jewish self-government with Jewish police can be given to these ghettos under supervision.”

The “Temporary guidelines for the treatment of the Jews in the territory of the Reichskommissariat Ostland”, which were presented to Rosenberg on August 13, 1941, also planned strict measures for the exclusion of Jews from public life and their concentration in ghettos:⁵⁵²

“The Jews are to be concentrated as far as is practicable in cities or sections of cities, which already have a predominantly Jewish populace. Ghettos are to be established there. The Jews are to be prohibited from leaving the ghettos. In the ghettos, they are to be allowed to have as much food as the rest of the populace can do without, but not more than necessary for a scanty nutrition of the occupants. The same applies to supplying them with essential goods.”

After a reference to the self-government in the ghettos, the “Guidelines” deal with deployment of the Jews for labor:

“The Jews who are capable of working are to be conscripted for forced labor according to the need for labor. The economic interests of residents who are worthy of advancement, are not to be permitted to be injured by the Jewish forced labor. The forced labor can be performed in work parties outside of the ghettos, inside the ghetto, or, where ghettos have not yet been established, also individually outside of the ghettos (e.g. in the workshops of the Jews).”

These orders went into effect in the general district of Latvia on September 1, 1941.⁵⁵³

⁵⁵¹ “Richtlinien für die Führung der Wirtschaft in den neubesetzten Ostgebieten” (Grüne Mappe), Berlin, September 1942. EC-347. IMT, Vol. XXXVI, p. 349.

⁵⁵² PS-1138.

⁵⁵³ “Orders for the treatment of Jews in the region of the former Free State of Latvia,” issued by the Generalkommissar in Riga on August 30, 1941. GARF, 7445-2-145, pp. 29f.

On September 12 of that year, Wilhelm Keitel, commander of the General Headquarters of the Wehrmacht, issued a directive dealing with the subject “Jews in the newly occupied territories of the east,” which begins as follows:⁵⁵⁴

“The struggle against Bolshevism demands ruthless and energetic measures above all also against the Jews, the main sponsors of Bolshevism.”

This struggle did not mean, however, the extermination of the Jews, but merely the prohibition of collaboration with the Jewish populace as well as of the entry of individual Jews into the auxiliary services of the Wehrmacht. The employment of Jews was permitted exclusively “in specially collected labor crews” under German supervision.

On October 1, 1941, *SS-Sturmbannführer* Ehrlinger, with permission of his superior Franz Stahlecker, head of *Einsatzgruppe A*, composed a note on the subject “Establishment of a Concentration Camp in Latvia.” It proposed the formation of a camp in the vicinity of Riga for approximately 3,000 prisoners in jails and for approximately 23,000 Jews living in the ghetto of Riga. The prisoners were supposed to be employed at the cutting of peat and the production of tiles. As to the Jews, it said:⁵⁵⁵

“It can now be said that the intended space offers many possibilities of this sort, which can enable all Jews still in Riga and in Latvia in general to be collected there. In doing so, the Jews must be separated from the Jewesses from the start, in order to prevent further reproduction. Children under 14 years of age must remain with the women.”

The proposal was approved by Reichsminister Rosenberg. On December 4, 1941, he wrote a letter to *Reichskommissar* Lohse on the subject of “Solution of the Jewish Question,” in which he reported the following:⁵⁵⁶

“The suggestions of Herr Generalkommissar in Riga with regard to the transportation of Jews from the Altreich to Riga and the establishment of Jewish camps have been passed on to me. As SS-Obergruppenführer Heydrich reported at a meeting a few days ago, the Jewish camp whose construction was planned at Riga is supposed to go into the Plaskau region.”

6. Direct Transports of Jews to the Eastern Territories

The deportation of 50,000 Jews from the Protectorate and the Altreich to Minsk and Riga, decided upon during the meeting of October 10, 1941, began a month later. However, it represented only the first step of the deportations, since the deportees were supposed to be taken even farther east. One of the

⁵⁵⁴ GARF, 7445-2-145, p. 34.

⁵⁵⁵ RGVA, 504-2-8, pp. 148-150.

⁵⁵⁶ GARF, 7445-2-145, p. 64.

first reports concerning the deportations into the *Ostland* is a telegram of November 9, 1941, directed to Rosenberg by Lohse, which reads as follows:⁵⁵⁷

“Security Police reports implementation of the transport of 50,000 Jews into the Ostland. Arrival of the 1st transport at Minsk, November 10, in Riga, November 19. Urgently request to prevent transports, since Jewish camps must be shifted considerably farther to the east.”

On the same day, Dr. Leibbrand, head of the office at the Rosenberg Ministry, sent the following telegram to Lohse:⁵⁵⁸

“Regarding transports of Jews into the Ostland.

Precise message on its way. Jews are coming farther east. Camps in Riga and Minsk only temporary measures, no objections on that account here.”

The local authorities were anything but delighted about the influx of these western Jews and lodged protests against it several times. On November 20, 1941, the Wehrmacht commander of the *Ostland* wrote a letter to Lohse on the subject “Transportation of Jews from Germany to White Russia,” in which he explained:⁵⁵⁹

“According to a report of the 707th Division, 25,000 Jews are supposed to be transported out of Germany to White Russia, of which 3,000 are allegedly intended for Minsk and 1,500 have already arrived from Hamburg. The immigration of German Jews, who are far superior in intelligence to the masses of the White Russian population, means a great danger to the pacification of White Russia.”

The Jewish population of White Russia, the letter continued, was “Bolshevist and capable of every attitude hostile to Germany” as well as active in the resistance. Therefore, the German-Jewish new arrivals would make contact with Communist organizations. For this reason as well as because the deportations would hinder the transports for the Wehrmacht, the Wehrmacht commander asked that

“arrangements be made that no Jews come from Germany to White Russia.”

But the protests faded away unheard. On November 20, 1941, Stahlecker reported to Lohse:⁵⁶⁰

“The transports of Jews are at present arriving in Minsk as planned.

Of the 25 transports which originally were destined for Riga, the first 5 were diverted to Kauen^[561].”

A note of January 13, 1942, from Lohse’s office reiterated:⁵⁶²

⁵⁵⁷ GARF, 7445-2-145, p. 52.

⁵⁵⁸ GARF, 7445-2-145, p. 54 and p. 51 (transcription of the telegram).

⁵⁵⁹ GARF, 7445-2-145, pp. 60f.

⁵⁶⁰ GARF, 7445-2-145, p. 62.

⁵⁶¹ German name for Kaunas.

⁵⁶² GARF, 7445-2-145, p. 67.

“Presented to Herr Reichskommissar [Lohse] with the request that he take note of the report of the City Commissioner in Minsk concerning the evacuation of reportedly 50,000 Jews from Germany to Minsk.

If not ordered otherwise by Herr Reichskommissar, the order of November 28 remains in force, according to which no objections are to be raised against any kind of transports from the Reich.”

On January 5, 1942, the City Commissioner of Minsk, Janetzke, who opposed the deportations into this city, turned directly to Rosenberg. He wrote the latter a letter in re “Evacuation of Jews from Germany to Minsk,” in which he explained that he had heard that the central authorities had the intention

“of bringing approximately 50,000 more Jews from Germany to Minsk in the next weeks and months.”

About 100,000 civilians lived in that city, which literally lay in ruins, and also “about 7,000 Jews from Germany” as well as “roughly from 15,000 to 18,000 Russian Jews” as prisoners. Thus, no possibility existed of accommodating any more people. To these difficulties, “the very serious problem of feeding the population (including the Jews)” was added. For these reasons, Janetzke asked for the cessation of the Jewish transports to Minsk.⁵⁶³

District Court Judge Wetzel responded on behalf of Rosenberg in a letter dated January 16, 1942, which was directed to Reich Commissioner Lohse:⁵⁶⁴

“Re: Evacuation of Jews from Germany to Minsk.

The letter of January 5, 1942, from the Herr City Commissioner of Minsk, copy enclosed, of which I ask you to take note, was sent to me.

According to a communication of the Reich Security Headquarters imparted to me, it was planned to send 25,000 Jews from the Reich to Minsk, who were supposed to be accommodated in the ghetto there. Of these, 7-8,000 Jews have reached Minsk. The rest who remained behind cannot be transferred to Minsk at this time due to transportation difficulties. As soon as these difficulties are removed, however, the arrival of these Jews in Minsk must be reckoned with. I ask to instruct the City Commissioner of Minsk in this regard and I further request him to contact the Senior Police Chief in charge with regard to the question of accommodating and feeding the Jews. I ask to suggest to him further that he adhere to the chain of command in future.”

However, on February 6, 1942, in a letter to Lohse, the Generalkommissar for White Russia, William Kube, supported Janetzke’s request. He pointed out how impossible it was in a city like Minsk, 80 percent of which lay in ruins, to

⁵⁶³ GARF, 7445-2-145, pp. 65f.

⁵⁶⁴ GARF, 7445-2-145, p. 68.

accommodate yet an additional 25,000 Jews.⁵⁶⁵ On June 26, 1942, the Chief of the Security Police and of the SD reported:⁵⁶⁶

“Also in White Russia, the measures taken by the Security Police and the SD have to cause fundamental changes in the area of the Jewish question. In order first to bring the Jews under effective supervision, independent of later measures yet to be taken, Jewish Councils of Elders were employed, which are responsible to the Security Police and the SD for the attitude of their racial comrades. Above and beyond this, the registration of the Jews and their consolidation in ghettos has been started. Lastly, the Jews have been made recognizable by a yellow badge to be worn on the chest and back, after the manner of the Jewish star introduced in the Reich territory. In order to evaluate the labor potential of the Jews, they are generally being taken into the private labor assignments and employed in cleaning up. With these measures, the foundations for the later intended final solution of the European Jewish question have been created for the White Russian territory as well.”

The measures were nothing other than the concrete implementation of the policy as laid out in the ‘Brown Portfolio,’ which intended a future solution of the Jewish problem “for all of Europe after the war.”

7. Numerical Data on Direct Transports to the Eastern Territories

The existing railway documents⁵⁶⁷ make it possible for us to draw only a part of the entire picture of the transports of Jews directly into the eastern territories. The transports arriving from the territory of the Reich were organized by the German *Reichsbahn* (Reichsbahndirektion in Königsberg), whose duty was to inform all departments involved. The transports received the abbreviation ‘Da’⁵⁶⁸ and were numbered consecutively. The empty trains, designated by ‘Lp,’ were assigned numbers above 1,000.

The following transports are known:⁵⁶⁹

⁵⁶⁵ GARF, 7445-2-145, pp. 72f.

⁵⁶⁶ “Meldungen aus den besetzten Ostgebieten Nr. 9”, Berlin, June 26, 1942, RGVA, 500-1-755, p. 190.

⁵⁶⁷ Some documents concerning the transports to Minsk are found in the National Archive of the Republic of White Russia (Natsionalni Archiv Republiki Belarus, NARB) under the inventory number 378-1-784.

⁵⁶⁸ According to many authors this stands for David.

⁵⁶⁹ Raul Hilberg, *op. cit.* (note 268). Heiner Lichtenstein, *Mit der Reichsbahn in den Tod*, Bund-Verlag, Düsseldorf 1985. Raisa A. Chernoglazova, *Judenfrei! Svobodno ot Evreev! Istoria Minskogo Getto v dokumentach*, Minsk 1999, pp. 223f. Christian Gerlach, *op. cit.* (note 418), pp. 758f. Wolfgang Benz, *Dimension des Völkermords*, *op. cit.* (note 79), pp. 46f and

Train #	Departure Date	Departure	Destination	Deportees
?	November 4, 1941	Berlin	Riga	?
?	November 8, 1941	Hamburg	Minsk	990
?	November 10, 1941	Düsseldorf	Minsk	993
?	November 11, 1941	Frankfurt/M.	Minsk	1042
?	November 14, 1941	Berlin	Minsk	1,030
?	November 15, 1941	Munich	Riga	?
?	November 16, 1941	Brünn	Minsk	1,000
?	November 17, 1941	Berlin	Kaunas	?
?	November 18, 1941	Hamburg	Minsk	398 ⁵⁷⁰
?	November 22, 1941	Frankfurt/M.	Riga	?
?	November 23, 1941	Vienna	Kaunas	995
?	November 27, 1941	Berlin	Riga	?
?	November 27, 1941	Munich	Riga	?
?	November 29, 1941	Nuremberg	Riga	820
?	December 1, 1941	Stuttgart	Riga	980
?	December 3, 1941	Vienna	Riga	995
?	December 6, 1941	Hamburg	Riga	765
?	December 6, 1941	Cologne	Riga	1,000
?	December 9, 1941	Kassel	Riga	991
?	December 11, 1941	Düsseldorf	Riga	1,020
?	December 15, 1941	Hanover	Riga	1,000
?	January 9, 1942	Theresienstadt	Riga	1,000
?	January 11, 1942	Vienna	Riga	1,000
?	January 13, 1942	Berlin	Riga	?
?	January 15, 1942	Theresienstadt	Riga	1,000
?	January 19, 1942	Berlin	Riga	?
?	January 21, 1942	Leipzig	Riga	1,000
?	January 25, 1942	Riga	Riga	1,350
?	January 25, 1942	Berlin	Riga	?
?	January 25, 1942	Vienna	Riga	1,196
?	February 6, 1942	Vienna	Riga	997
Da-201	May 6, 1942	Vienna	Minsk	1,000
Da-202	May 12, 1942	Vienna	Minsk	1,000
Da-203	May 20, 1942	Vienna	Minsk	1,016
?	May 26, 1942 ⁵⁷¹	Germany	Minsk	998
Da-204	May 27, 1942	Vienna	Minsk	998
Da-205	June 2, 1942	Vienna	Minsk	1,000
Da-206	June 9, 1942	Vienna	Minsk	1,006
Da-207	June 16, 1942	Vienna	Minsk	1,000
Da-208	June 23, 1942	Vienna	Minsk	1,000
Da-40	June 24, 1942	Königsberg	Minsk	770

78. Miroslav Kárný, *Terezinská paměti kniha*. Terezinská Iniciativa, Melantrich 1995, Vol. I, 63-67; Robert Kempner, *Eichmann und Komplizen*, *op. cit.* (note 533), p. 116.

⁵⁷⁰ Deportation list 3. Transport. NARB, 738-1-784.

⁵⁷¹ Arrival date.

Train #	Departure Date	Departure	Destination	Deportees
Da-209	June 30, 1942	Vienna	Minsk	1,000
Da-210	July 7, 1942	Vienna	Minsk	1,000
Da-211	July 14, 1942	Vienna	Minsk	1,000
Da-220	July 14, 1942	Theresienstadt	M. Trostinec	1,000
Da-212	July 21, 1942	Vienna	Minsk	1,000
Da-219	July 22, 1942	Cologne	Minsk	?
Da-213	July 28, 1942	Vienna	Minsk	1,000
Da-221	July 28, 1942	Theresienstadt	Baranovici	1,000
Da-214	August 4, 1942	Vienna	Minsk	1,000
Da-222	August 4, 1942	Theresienstadt	M. Trostinec	1,000
Da-215	August 11, 1942	Vienna	Minsk	1,000
Da-223	August 17, 1942	Vienna	Minsk	1,003
Da-216	August 18, 1942	Vienna	Minsk	1,000
?	August 20, 1942	Theresienstadt	Riga	1,000
Da-217	August 25, 1942	Vienna	Minsk	1,000
Da-224	August 25, 1942	Theresienstadt	M. Trostinec	1,000
?	August 31, 1942	Vienna	Minsk	967
Da-218	September 1, 1942	Vienna	Minsk	1,000
?	September 1, 1942	Theresienstadt	Raasiku	1,000
Da-226	September 8, 1942	Theresienstadt	M. Trostinec	1,000
?	September 14, 1942	Vienna	Minsk	992
Da-228	September 22, 1942	Theresienstadt	M. Trostinec	1,000
Da-229	September 30, 1942	Vienna	Minsk	1,000
Da-230	October 7, 1942	Vienna	Minsk	1,000
?	November 18, 1942	Hamburg	Minsk	908
?	November 28, 1942	Vienna	Minsk	999
			Total:	56,221

The four transports that left Berlin for Riga on November 4, 1941, and on January 13, 19, and 25, 1942, included approximately 5,000 persons.⁵⁷² In the period from November 17, 1941,⁵⁷³ to February 6, 1942, a total of 25,103 Jews in 25 transports were brought to Riga,⁵⁷⁴ but only 15,114 are on the list. Thus, the total number of deportees increases to (5,000 + 56,221 + [25,103-15,114] =) 71,210. The Korherr Report helps us to close the gaps in documentation and to draw a more complete picture of the transports of Jews to the east in the year 1942. We shall address this question in Chapter VIII.

⁵⁷² W. Benz, *Dimension des Völkermords*, op. cit. (note 79).

⁵⁷³ This transport arrived in Riga on November 19.

⁵⁷⁴ Enclosure with the "Meldungen aus den besetzten Ostgebieten" No. 10 from July 3, 1942. RGVA, 500-1-775, p. 233.

Chapter VII: The Role of the *Einsatzgruppen* in the Occupied Eastern Territories

1. Initial Situation

Since, according to orthodox historians, the Germans in the occupied Soviet territories are supposed to have pursued a policy of systematic extermination of Jews, we must deal with the objection that at the end of the day it does not matter whether the Jews were gassed in Poland in extermination camps or, after their deportation to the east, were shot there. For this reason we will now turn to the question of whether this systematic extermination of Jews in the eastern territories actually occurred. In clarifying this question, the examination of the *Einsatzgruppen* and their missions will play a central role.

Soon after the German invasion into the USSR, four *Einsatzgruppen* altogether numbering 3,000 men – including non-combat troops such as drivers, interpreters, and radiomen⁵⁷⁵ – became operational in the conquered regions. One of their missions indisputably consisted of securing the rear, *i.e.*, fighting against partisans. According to the official historiography, however, other, more sinister tasks were assigned to the *Einsatzgruppen*. By referring to a postwar affidavit by Otto Ohlendorf,⁵⁷⁶ leader of *Einsatzgruppe D*, Raul Hilberg summarizes as follows:⁵⁷⁷

⁵⁷⁵ Raul Hilberg, *op. cit.* (note 17), p. 289. From October 15, 1941, to February 1, 1942, the strength of *Einsatzgruppe A* sank from 990 to 909 men; the percentage of combat troops fell from 725 men (= 73.2% of the total strength) to 588 (64.7%). *Ibid.* (Oct. 15, 1941), and RVA, 500-4-92, p. 183, “Total Strength of *Einsatzgruppe A* on 1 February 1942.”

⁵⁷⁶ PS-3710. – However, Alfred Streim, Director of the Ludwigsburg Central Office for the Resolution of NS Crimes, wrote regarding this:

“Ohlendorf’s testimony and submissions concerning the inauguration of the ‘Führer Order’ [...] are false. In the Einsatzgruppen Trial the former Head of Einsatzgruppe D was able to get his co-defendants to submit to a line of defense put forward by him with the suggestion that if one had, from the very beginning, carried out the extermination operations against the Jews on ‘order of the Führer,’ one could count upon a more lenient sentence.”

(A. Streim, “Zur Eröffnung des allgemeinen Judenvernichtungsbefehls gegenüber den *Einsatzgruppen*”, in: E. Jäckel, J. Rohwer, *op. cit.* (note 275), p. 303.)

⁵⁷⁷ Raul Hilberg, *op. cit.* (note 17), p. 290.

“According to Ohlendorf, the commanders of the Einsatzgruppen were briefed by Himmler personally. They were informed that an important part of their task was the elimination (Beseitigung) of Jews – women, men, and children – and of Communist functionaries.”

According to Hilberg, the *Einsatzgruppen* killed over 900,000 Soviet Jews, which corresponded to approximately “two-thirds” of the Jewish victims in the territories conquered by the Germans; the rest were killed by Wehrmacht, SS, police units, as well as by Romanians allied with the Germans, or died in camps and ghettos.⁵⁷⁸

As proof for the several hundred thousand murders committed by the *Einsatzgruppen*, first and foremost are cited the so-called “*Ereignismeldungen*” (event reports), which fall into the period from June 1941 to May 1942 and mention numerous massacres, with victims occasionally numbering in five digit figures. The documents are supposed to have been found by the Allies in the offices of the Berlin Reichssicherheitshauptamt. That the Germans let this sort of incriminating material fall into the hands of their enemies, although they could have easily burned the few stacks of papers in time, is strikingly odd. In fact, some revisionist researchers have expressed doubt as to the authenticity of the event reports and are of the opinion that at least in part we are dealing with manipulated documents. The main argument for this thesis lies in the absence of evidence for mass killings of the scope claimed; we shall return to this question. Further grounds are advanced by Arthur Butz:⁵⁷⁹

“They [the documents] were mimeographed, and signatures are most rare and, when they occur, appear on non-incriminating pages. Document NO-3159, for example, has a signature of a R. R. Strauch, but only on a covering page giving the locations of various units of the Einsatzgruppen. There is also NO-1128, allegedly from Himmler to Hitler reporting, among other things, the execution of 363,211 Russian Jews in August-November 1942. This claim occurs on page 4 of NO-1128, while initials said to be Himmler’s occur on the irrelevant page 1. Moreover, Himmler’s initials were easy to forge: three vertical lines with a horizontal line drawn through them.”

Udo Walendy adds:⁵⁸⁰

“As the American military court in the OKW Trial [Oberkommando der Wehrmacht, General Headquarters] already stated, even this court was surprised at how conspicuously vague the existing ‘USSR Event Reports’ were with respect to location, point in time, units, and other details such as troop strength, armaments, auxiliary forces, logistics etc. Merely the num-

⁵⁷⁸ *Ibid.*, p. 390.

⁵⁷⁹ Arthur Butz, *op. cit.* (note 108), p. 260.

⁵⁸⁰ Udo Walendy, “Einsatzgruppen im Verband des Heeres. 1. Teil”, in: *Historische Tatsachen* No. 16, Vlotho 1983, p. 5. The second part of this study appeared in No. 17 of the same journal (1983).

ber on a piece of paper, which was written or is supposed to have been written in Berlin, is too little proof for an historian, even if the report itself is possibly authentic and only the number legible today on this piece of paper may have been manipulated, which at a closer examination of the documents seems to be the case."

An even stronger argument is that a policy of mass extermination in the occupied Soviet territories would have stood in glaring contrast not only to the National Socialist policy of resettlement of the Jews to the east (cf. Chapters VI and VIII), but also to several reports of the *Einsatzgruppen* themselves. We have already determined that the "Reports from the Occupied Eastern Territories" No. 9 of June 26, 1942, following a description of the ghettoization measures taken by the Security Police and the steps toward exploitation of the work force of the Ruthenian Jews, conclude as follows:⁵⁸¹

"With these measures, the foundations for the later intended final solution of the European Jewish question have been created for the White Russian territory as well."

Event Report No. 52, of August 14, 1941, proposed employing the great mass of the Jews in the following project:⁵⁸²

"Cultivation of the Pripyet marshes and the marshes on the northern Dnieper as well as the Volga."

In the following, we refrain from taking any position regarding the authenticity of the event reports, and merely examine the question of whether the content of the documents, independent of their authenticity, reflects historical facts.

It can hardly be seriously contested that the *Einsatzgruppen* committed numerous mass shootings. For our subject, however, there are only two issues of decisive significance:

Were the *Einsatzgruppen* assigned the task of systematically exterminating the Soviet Jews?

Were the western Jews, which had been deported into the eastern territories, treated like the Soviet Jews?

2. Reasons for Mass Shootings

With regard to the first of the two questions we have raised, it can be validly affirmed that the policy of the shooting of Jews was not directed against all eastern Jews and was not generally directed against Jews as such. In a memorandum written on April 29, 1941, Alfred Rosenberg had specified:⁵⁸³

⁵⁸¹ See Chapter VI, Section 6.

⁵⁸² See Chapter VIII, Section 5.

⁵⁸³ PS-1024.

“The Jewish problem demands a general treatment, the interim solution of which must be determined (compulsory labor of the Jews, ghettoization, etc.).”

On May 7, 1941, Rosenberg established in his “Instructions for a Reichskommissar in the Ukraine”:⁵⁸⁴

“After the removal of the Jews from all public positions, which will occur as a matter of course, the Jewish problem will experience a crucial solution through the establishment of ghettos or labor gangs. Compulsory labor is to be introduced.”

The ‘Brown Portfolio,’ in the paragraph “Social stratum,” distinguished two categories of eastern Jews:⁵⁸⁵

“In the individual Reich Kommissariats and within these in the General Kommissariats, Jewry comprises a variously large portion of the general population. For example, in White Russia and in the Ukraine there are millions of Jews who have been resident here for generations. In the central territories of the USSR, on the other hand, a far greater portion of the Jews has moved there only during the Bolshevik era. A special group is formed by Soviet Jews who have intruded into eastern Poland, western Ukraine, western White Ruthenia, the Baltic countries, Bessarabia, and Bukovina in the train of the Red Army in 1939 and 1940. To some extent varied manners of handling these different groups are in place.

First and foremost, the Jews who have moved into the territories newly occupied by the Soviets in the past two years, insofar as they have not fled, are to be removed with severe measures. Since these groups have made themselves hated to a great degree due to their terrorizing of the populace, their elimination has already been taken care of for the most part by the populace itself at the appearance of German troops. These sorts of retaliatory measures are not to be opposed. The rest of the resident Jewish population is first of all to be registered by the introduction of the obligation to report. All Jews are being marked by visible symbols (yellow Jewish stars).”

The “Soviet Jews” were shot, while the great majority of the remaining resident Jewish population was ghettoized. But many other eastern Jews were killed as well: on account of sabotage, anti-German activities, as carriers of diseases, and above all in retaliatory measures for partisan attacks.

This emerges clearly from the first reports of the *Einsatzgruppen*. Here is an excerpt from one of these reports:⁵⁸⁶

⁵⁸⁴ PS-1028.

⁵⁸⁵ In: *Grüne Mappe*, *op. cit.* (note 540), pp. 348f.

⁵⁸⁶ Activity and Situation Report No. 6 of the *Einsatzgruppen* of the Security Police and the SD in the USSR (period of report from October 1 to 31, 1941). RGVA, 500-1-25/1, pp. 221f.

“[White Russia.] In Gorodnia, 165 Jewish terrorists and in Chernigov 19 Jewish Communists were liquidated; another 8 Jewish Communists were shot in Beresna.

It was frequently found that Jewish women displayed especially rebellious behavior. For this reason, 28 Jewesses in Krugloye and 337 Jewesses in Mogilev had to be shot.

In Borissov 331 Jewish saboteurs and 118 Jewish looters were executed.

In Bobruisk 380 Jews who had been conducting, right up to the end, defamatory and atrocity propaganda against the German occupation troops were shot.

In Tatarsk the Jews had arbitrarily left the ghetto and returned to their old quarter, where they were attempting to drive out the Russians billeted there in the meantime. All male Jews and 3 Jewesses were shot. On the establishment of a ghetto in Sandrudubs the Jews in part resisted, so that 272 Jews had to be shot. Among them was a political commissar.

The Jews in Mogilev also tried to sabotage their resettlement into the ghetto. 113 Jews were liquidated.

In addition 4 Jews were shot for refusal to work, and 2 Jews because they mistreated wounded German soldiers and had not put on the prescribed symbol.

222 Jews were shot in Talka on account of anti-German propaganda, and 996 Jews in Marina Gorka because they were sabotaging orders issued by the German occupation authorities.

Another 627 Jews were shot at Shklov because they took part in acts of sabotage.

Due to extreme danger of infection, the liquidation of Jews lodged in the ghetto in Vitebsk was begun. There were approximately 3,000 Jews.”

As we shall see in the following section, there are good reasons to doubt the preceding figures. But the text does prove that the *Einsatzgruppen* were not given the mission of the complete extermination of the Jews, since otherwise the distinction between the Jews executed for specific reasons and the rest of the Jews would of course have been totally superfluous.

The most logical argument for the mass shootings actually carried out by the *Einsatzgruppen* might therefore be that, which the Jewish historian Arno Mayer summarizes as follows:⁵⁸⁷

“Even so, and notwithstanding the unparalleled magnitude of the Jewish suffering, the extermination of eastern Jewry never became the chief objective of Barbarossa. The fight for Lebensraum and against bolshevism was neither a pretext nor an expedient for the killing of Jews. Nor was it a mere smoke screen to disguise the Jewish massacres as reprisals against parti-

⁵⁸⁷ Arno Mayer, *Why Did the Heavens Not Darken? The “Final Solution” in History*, Pantheon Books, New York 1988, p. 270.

sans. The assault on the Jews was unquestionably intertwined with the assault on bolshevism from the very outset. But this is not to say that it was the dominant strand in the hybrid 'Judeobolshevism' that Barbarossa targeted for destruction. In fact, the war against the Jews was a graft onto or a parasite upon the eastern campaign, which always remained its host, even or especially once it became mired deep in Russia.

When they set forth on their mission, Einsatzgruppen and the RSHA were not given the extermination of Jews as their principal, let alone their only, assignment."

According to Mayer, the massacres of the eastern Jews were not part of a comprehensive plan of extermination, but occurred as the result of the inexorable radicalization of the war in the east and because the eastern Jews were classified by the SS as carriers of Bolshevism.

3. The Scale of the Shootings

The shootings carried out by the SS were in no way as extensive as claimed by the orthodox historians, for the numbers mentioned in the relevant reports cannot be confirmed objectively and in many cases are demonstrably wrong. We now cite some examples:

a. The Number of Jews Killed in Latvia

In a long general report concerning the activity of *Einsatzgruppe A* the following data were given:⁵⁸⁸

"The total number of Jews in Latvia in the year 1935 was: 93,479 or 4.7% of the whole population. [...]

At the entry of German troops there were still 70,000 Jews in Latvia. The rest had fled with the Bolsheviks. [...]

Up until October 1941, about 30,000 Jews were executed by this Sonderkommando. The remaining Jews, still indispensable due to economic importance, were collected in ghettos. In the course of dealing with criminal cases involving not wearing the Jewish star, black marketing, theft, fraud, but also on account of preventing danger of epidemics in the ghettos, further executions were carried out afterwards. Thus, on November 9, 1941, 11,034 were executed in Dünaburg, 27,800 in Riga at the beginning of December 1941 by an operation ordered and carried out by the Senior SS- and Police Chief, and 2,350 in Libau in mid-December 1941. At this time there are Latvian Jews in the ghettos (aside from the Jews from the Reich) in:

⁵⁸⁸ "Einsatzgruppe A, Gesamtbericht vom 16 Oktober 1941 bis 31 Januar 1942", RGVA, 500-4-92, pp. 57-59.

<i>Riga</i>	<i>approximately</i>	2,500
<i>Dünaburg</i>	"	950
<i>Libau</i>	"	3,000."

Let us summarize:

– Jews present at the entry of German troops:	70,000
– Jews shot up to October 1941:	30,000
– Ghetto Jews shot (11,034+27,800+2,350=):	41,184
– Ghetto Jews still living (2,500+950+300=):	3,750

But if we add together the numbers of those shot (30,000 + 41,184 =) 71,184 and those still living in the ghettos (3,750), we get 74,934 Jews, a number which is higher than the number allegedly present at the entry of the Germans into Latvia. In a table that summarizes the report and bears the title "Number of executions carried out by Einsatzgruppe A up to February 1, 1942," the number of those shot is stated as 35,238, to which are added 5,500 Jews killed "by pogroms," but "from December 1, 1941";⁵⁸⁹ we therefore have 40,738 Jewish victims. Although this figure includes an additional 5,500 Jews killed in pogroms not mentioned in the report, the total number of those shot is far lower: 40,738 as opposed to 71,184.

b. The Number of Jews Killed in Lithuania

No less strange are the corresponding figures for Lithuania:⁵⁹⁰

"According to one census, up until the entry of the Bolshevists 153,743 Jews were living in Lithuania in the year 1929, which thus constituted 7.58% of the entire population. [...]"

In many single actions a total of 136,421 Jews were liquidated. [...]"

Jews in the ghettos:

<i>Kaunas</i>	<i>approximately</i>	15,000 Jews
<i>Vilnius</i>	"	15,000 Jews
<i>Šiauliai</i>	"	4,500 Jews."

In adding the numbers of those shot (136,421) and those still living in the ghettos (34,500), we arrive at a figure, which is once again higher than the initial number (153,743). If, however, one assumes that, as in the case of Latvia, approximately 25% of the Jewish population had fled with the Bolshevists, then the number of Jews still present in Lithuania at the entry of the Germans would have been far lower: approximately 115,000.

c. Lithuanian Jews in Territories Annexed by the Reich

Gerald Reitlinger writes that up to the point in time when Franz Stahlecker, head of *Einsatzgruppe* A, composed his report, 50,000 Jews had been living in

⁵⁸⁹ *Ibid.*, p. 184.

⁵⁹⁰ *Ibid.*, pp. 59-61.

Latvia and Lithuania (as opposed to the 38,250 mentioned by Stahlecker), but that the number of surviving Jews was significantly higher because some Lithuanian areas – Memelland and the region around Suwałki and Grodno – had been incorporated into the *Reich*. Approximately 40,000 Jews lived in the two ghettos of Grodno, and 18,435 Jews were still living in the Königsberg district, to which Memel and Suwałki belonged, at the end of 1942, consisting almost exclusively of “Soviet Russian Jews,”⁵⁹¹ according to the Korherr Report.

d. Simferopol and the Manstein Trial

General Field Marshall Erich von Manstein was commander of the Eleventh Army, fighting on the Black Sea and in the Crimea. In 1949, he was tried by a British military court in Hamburg on charges of complicity in the massacres committed by *Einsatzgruppe D*. His defense counsel was the Englishman Reginald T. Paget, who wrote a book – translated into German the year after – about the trial in 1951.⁵⁹² In it, he reports the following concerning the activities of *Einsatzgruppe D* in the Crimea:⁵⁹³

“It seemed to me that the S.D. claims were quite impossible. Single companies of about 100 with about 8 vehicles were reporting the killing of up to 10,000 and 12,000 Jews in two or three days. They could not have got more than about 20 or 30 Jews who, be it remembered, thought they were being resettled and had their traps with them, into a single truck. Loading, travelling at least 10 kilometres, unloading and returning trucks would have taken nearer two hours than one. The Russian winter day is short and there was no travelling by night. Killing 10,000 Jews would have taken at least three weeks.

In one instance we were able to check their figures. The S.D. claimed that they had killed 10,000 in Simferopol during November and in December they reported Simferopol clear of Jews. By a series of cross checks we were able to establish that the execution of the Jews in Simferopol had taken place on a single day, 16th November. Only one company of S.D. were in Simferopol. The place of execution was 15 kilometres from the town. The numbers involved could not have been more than about 300. These 300 were probably not exclusively Jews but a miscellaneous collection of people who were being held on suspicion of resistance activity. The Simferopol incident received a good deal of publicity because it was spoken of by the prosecution’s only witness, an Austrian corporal called Gaffa who said

⁵⁹¹ G. Reitlinger, *op. cit.* (note 180), p. 233f., as well as NO-5194.

⁵⁹² Von Manstein was acquitted of the charge of complicity in the massacre of Jews but was found guilty of not having protected the lives of the civilian population, and on December 19 was sentenced to 18 years in prison. The length of sentence was later decreased to 12 years and von Manstein was released in May 1953.

⁵⁹³ Reginald T. Paget, *Manstein. His Campaigns and his Trial*, Collins, London 1951, p. 170f.

that he heard anti-Jewish activities mentioned on an engineers' mess when he was orderly and had passed the scene of the Simferopol execution. As a result we received a large number of letters, and were able to call several witnesses who had been billeted with Jewish families and also spoke of the functioning of the local synagogue and of a Jewish market where they bought icons and similar bric-a-brac right up to the time that Manstein left the Crimea and after.

It was indeed clear that the Jewish community had continued to function quite openly in Simferopol and although several of our witnesses had heard rumours about an S.D. excess committed against Jews in Simferopol, it certainly appeared that this Jewish community was unaware of any special danger.

Ohlendorf had reported that not only Simferopol but the whole Crimea was cleared of Jews. He was clearly a man who was prepared to say anything that would please his employers. The Americans found him a perfect witness."

e. Babi Yar

In "Activity and Situation Report No. 6 of the Einsatzgruppen of the Security Police and the SD in the USSR," we read this concerning the time period from October 1 to 31, 1941:⁵⁹⁴

"In Kiev all the Jews were arrested and on September 29 and 30, a total of 33,771 Jews were executed."

This pertains to the (in)famous 'Massacre of Babi Yar.' However, as Udo Walendy and Herbert Tiedemann have proved, the massacre never happened, at least not remotely in the scope claimed.⁵⁹⁵ Presumably several hundred people were shot near Kiev, as at Simferopol. We will come back to the case of Babi Yar.

f. Jews in Lithuanian Ghettos and Camps Who Were Unfit for Work

The reports of the *Einsatzgruppen* are not only questionable as to the number of Jews shot, but also with respect to their classification.

In the "General Report from October 16 to January 31, 1942," the presence of (allegedly) 34,500 Jews in the ghettos of Kaunas, Vilnius, and Šiauliai is explained as follows:⁵⁹⁶

⁵⁹⁴ 102-R. IMT, Vol. XXXVIII, pp. 292f.

⁵⁹⁵ Udo Walendy, "Babi Jar – Die Schlucht 'mit 33,771 murdered Jews'?", in: *Historische Tatsachen* No. 51, Verlag für Volkstum und Zeitgeschichtsforschung, Vlotho 1992. Herbert Tiedemann, "Babi Jar: Critical Questions and Comments", in: Germar Rudolf (ed.), *op. cit.* (note 80), pp. 509-538.

⁵⁹⁶ *Einsatzgruppe A. General Report from October 16 to January 31, 1942*, RGVA, 500-4-92,

“Since the complete liquidation of the Jews was not to be carried out for reasons of work assignment, the ghettos were formed, which are presently filled as follows [the numbers cited above are given here]. These Jews are employed in work essential for defense purposes.”

According to this, only Jews still fit for work had been permitted to live in the three ghettos named; by this logic, those unfit for labor, especially the children, would have all had to be killed. But according to a census carried out at the end of May 1942, 14,545 Jews whose names (together with date of birth, occupation, and address) have been published by the Jewish Museum of Vilnius were living in Vilnius. It emerges from these documents that of these 14,545 Jews, no fewer than 3,693 were children of 15 years of age or less. The number of children per age group is shown in the following table:⁵⁹⁷

YEAR OF BIRTH	AGE	NUMBER OF CHILDREN
1927	15	567
1928	14	346
1929	13	265
1930	12	291
1931	11	279
1932	10	216
1933	9	226
1934	8	195
1935	7	227
1936	6	229
1937	5	182
1938	4	188
1939	3	181
1940	2	117
1941	1	172
1942	a few months	12
Total:		3,693

Furthermore, among the Jews registered by the census there were also 59 persons 65 years of age or older. The eldest was the 90-year-old Chana Stamleriene, born in 1852.

The children lived with their families in the ghetto. For example, the Michalowski family, which lived in Dysnos house 5-10, consisted of Nachman, born 1905, Fruma, born 1907, Pesia, born 1928, Niusia, born 1932, Sonia, born 1935, Mane, born 1904, Sonia, born 1903, Motel, born 1930 and Chana, born 1933.⁵⁹⁸ The Kacew family, residence at Ligonines house 11-8, included the following members: Chaim, born 1909, Chava, born 1921, and

pp. 60f.

⁵⁹⁷ *Vilnius Ghetto: List of Prisoners*, Vol. 1. Vilnius 1996, p. 212, No. 163. (Text in Lithuanian, Russian, and English.)

⁵⁹⁸ *Ibid.*, p. 85.

Sloma, born 1941.⁵⁹⁹ The Schimelevitsch family, living at Rudninku house 7-12, consisted of Abram, born 1896, Chawa, born 1909, Sora, born 1938, and Riva, born 1941.⁶⁰⁰ Finally, the Cukerman family, residence at Stasuno house 12, had the following members: Kosel, born 1916, Sima, born 1912, Kusia, born 1932, Malka, born 1934, Abram, born 1904, Syfra, born 1909, and Bluma, born 1930.⁶⁰¹

Since the 3,693 children were living with their families, it is clear that the number of those unfit for work and those not able to be employed (mothers who had to care for their children) was even higher.

If the *Einsatzgruppen* had to liquidate all Jews or at least all Jews unfit for labor, then how is it that these 3,693 children were not murdered at the (alleged) dissolution of Ghetto No. 2 in October 1942?

How little the threat of death was hovering over these children can be gathered from the following description of the school system in the ghetto of Vilnius, furnished by Abraham Foxman:⁶⁰²

“Some days after the establishment of the ghetto, in 1941, a group of teachers founded a ‘Farein,’ [Verein = association/club] which later organized the educational system of the ghetto. At the first enrollment for the school, 3,000 children were registered. In the beginning, participation in classes was voluntary. In April 1943, it then became obligatory:

‘Directive No. 3, issued by the ghetto deputies on April 28, 1943, announces the attendance at the ghetto schools to be obligatory. All children from five to thirteen must attend the ghetto schools, which are free of cost. [...] The block chief is responsible for seeing that all children of obligatory school age take part in classes.’

In the first year of the ghetto, more than twenty educational units were founded, which comprised over 80% of the school-age children of the ghetto. Schools as well as H.K.P. – work institutions – were also founded in Kauen. Gens^[603] received permission from the Germans to fence-in an area in the woods outside of the ghetto. The teachers walked with groups of 100 to 150 children into the woods four times a week. Due to the outbreak of a scarlet fever epidemic, there was a delay in opening the schools in 1942. In October they resumed operation, and 1,500 to 1,800 children took part in classes. Apparently there were 60 teachers who gave 42 hours each week. The remaining 18 hours were devoted to work in the kitchen, visiting students and parents in their home, the repair of books and notebooks, as well as the conducting of various assemblies.”

⁵⁹⁹ *Ibid.*, p. 150.

⁶⁰⁰ *Ibid.*, p. 213.

⁶⁰¹ *Ibid.*, p. 329.

⁶⁰² Abraham Foxman, “Vilna – Story of a Ghetto,” in: Jacob Glatstein, Israel Knox, Samuel Margoshes (eds.), *Anthology of Holocaust Literature*, Atheneum, New York 1968, pp. 90f.

⁶⁰³ Jacob Gens, Chief of the Jewish Council of Vilnius.

On May 12, 1944, ‘Russian bandits’ attacked several institutions in Lithuania and looted them, among them.⁶⁰⁴

“At the Bohumelischki Jewish camp – 1592 – approx. 300 women, men and children, 5 to 6 MPI, some rifles.”

g. Jews Unfit for Work in the Ghetto of Brest

There are also other cases of ghettos, in which only Jews fit for work are supposed to have been permitted to live, but where quite a high percentage of old people and children resided as well. In the ghetto of Brest, among the somewhat more than 9,000 Jews whose ages are known, there were 932 persons over 65 years of age in the following age groups:

YEAR OF BIRTH	AGE	NUMBER OF PERSONS
1872-1876	66-70 years	397
1867-1871	71-75 "	309
1862-1866	76-80 "	152
1857-1861	81-85 "	57
1852-1856	86-90 "	14
1850-1851	91-92 "	3
Total:		932

The ghetto also housed 380 children 15 years of age (birth year 1927), 128 of 14 years (1928), 4 of 13 years (1929), one of 12 years (1930), one of 10 years (1932), and two of nine years (1933).⁶⁰⁵

h. Jews Unfit for Work in the Ghetto of Minsk

In a list from 1943 (month not given) of 878 Jews from the ghetto of Minsk, there are no fewer than 227 children of the following age groups:

YEAR OF BIRTH	AGE	NUMBER OF CHILDREN
1928	15 years	45
1929	14 "	28
1930	13 "	28
1931	12 "	17
1932	11 "	23
1933	10 "	10
1934	9 "	4
1935	8 "	9
1936	7 "	11
1937	6 "	17

⁶⁰⁴ “Report of the Kauen Sipo” of May 12, 1944. RGVA, 504-1-7, p. 41.

⁶⁰⁵ Raissa A. Tschernoglasova, *Tragedja Evreev Belorussi v 1941-1944 godach*, Minsk 1997, pp. 274-378.

YEAR OF BIRTH	AGE	NUMBER OF CHILDREN
1938	5 "	12
1939	4 "	17
1940	3 "	4
1941	2 "	2
Total:		227

The list also contains about a dozen elderly persons, of whom the oldest was born in 1857 and thus was 86 years of age.⁶⁰⁶

i. Transfers of Baltic Jewish Children to Stutthof

In the summer of 1944, numerous transports of Jews traveled from the former ghetto of Kaunas (Lithuania) – transformed into a concentration camp in fall 1943 – and from the ghetto of Riga (Latvia) to Stutthof. From July 12 to October 14, ten transports with a total of 10,458 Jews from Kaunas and six transports with a total of 14,585 Jews from Riga⁶⁰⁷ arrived at the Stutthof camp, located east of Danzig (today called Gdansk). As has already been established, in these transports, whose lists of names are fragmentarily preserved, there was quite a number of Baltic Jews (but others as well) of 15 years of age and under, who were designated on the lists as boys or girls. In the transport of July 12, 1944, which included 3,098 deportees (510 of them are known by name), there were 80 children (fifteen years old or younger). On the list of July 19, there are 88 children among 1,097 deportees (all but two identified by name). The following table gives information about the number of children and their respective age groups.

AGE	TRANSPORT OF JULY 13, 1944	TRANSPORT OF JULY 19, 1944
15 years	3	-
14 years	7	4
13 years	4	28
12 years	8	13
11 years	2	6
10 years	4	9
9 years	10	2
8 years	4	6
7 years	5	7
6 years	9	8
5 years	7	-

⁶⁰⁶ R.A. Chernoglazova, *Judenfrei! Svobodno ot Evreev!*, op. cit. (note 569), pp. 289-310.

⁶⁰⁷ Cf. the transport lists in: Jürgen Graf, C. Mattogno, *Concentration Camp Stutthof and Its Function in National Socialist Jewish Policy*, Theses & Dissertations Press, Chicago, IL, 2003, p. 97.

AGE	TRANSPORT OF JULY 13, 1944	TRANSPORT OF JULY 19, 1944
4 years	8	3
3 years	8	2
2 years	1	-
Total:	80	88

On July 26, 1944, 1,983 prisoners, for the most part Lithuanian Jews, were transferred to Auschwitz from Stutthof. Among them were 546 girls and 546 boys as well as 801 “women who were the mothers of the children.”⁶⁰⁸ A considerable portion of the list of names of this transport has been preserved. Of 1,488 prisoners whose age is known, 850 were children of the following age groups.⁶⁰⁹

YEAR OF BIRTH	AGE	NUMBER OF CHILDREN
1929	15 years	31
1930	14 "	117
1931	13 "	146
1932	12 "	94
1933	11 "	36
1934	10 "	61
1935	9 "	26
1936	8 "	58
1937	7 "	44
1938	6 "	61
1939	5 "	54
1940	4 "	60
1941	3 "	52
1942	2 "	8
1943	1 year	2
	Total:	850

Twenty-four of the 80 children mentioned in the transport of July 13 are recorded, as well as 84 of the 88 children mentioned in the transport of July 19.

On the transport, which departed Stutthof for Auschwitz on September 10, whose list of names can be partially reconstructed on the basis of the registration book,⁶¹⁰ there were at least 345 predominantly Lithuanian Jewish children and youths between the ages of 12 and 17, whose age distribution was as follows:

⁶⁰⁸ Telephone conversation of the commandant of Stutthof, Paul Hoppe, with the commandant of Auschwitz on July 26, 1944. AMS, I-IIC4, p. 94. ‘Procedure for taking charge’ of the transport of July 26 and 27, 1944. AMS, I-IIC-3, p. 43.

⁶⁰⁹ AMS, I-IIC-3, list of names of the transport of July 26, 1944.

⁶¹⁰ AMS, transport list, microfilm 262.

YEAR OF BIRTH	AGE	NUMBER OF CHILDREN
1927	17 years ⁶¹¹	56
1928	16 "	136
1929	15 "	119
1930	14 "	26
1931	13 "	6
1932	12 "	2
Total:		345

Since the transport lists are incomplete, the number of the boys and girls transferred from Kaunas and Riga must actually have been significantly larger than the approximately 1,250 documented cases. That these children were still in Kaunas and Riga in the summer of 1944 categorically refutes the claim that the *Einsatzgruppen* had been conducting a total extermination of the Jews or at least of those Jews unfit for labor.

But there is a still more compelling objection to the claims of mass extermination: the lack of material traces.

4. Operation 1005

After the discovery of the mass graves of Katyn and Vinnitsa by the Germans, Soviet propaganda went on the counterattack, principally by using two ploys: it attempted to place the blame for atrocities committed by the Soviet secret service, the NKVD (predecessor of the KGB), on the Germans, and it claimed that mass graves of victims of the Germans had been discovered.

As is well known, on April 13, 1943, in the forest of Katyn, not far from Smolensk, the Germans, following directions from the local populace, found seven mass graves with a total of 4,143 bodies of Polish officers who had been shot. Between April and June 1943 these remains were examined by a commission, which included medical doctors from 12 European nations, and further by a commission of the Polish Red Cross and by American, British, and Canadian officers who were prisoners of war. The Germans published an extraordinarily well-documented official dossier afterwards, which contained all the forensic results of the investigation, 80 photographs, and the names of the victims identified.⁶¹²

The massacre of Vinnitsa (Ukraine) was uncovered by the Germans at the beginning of June 1943. At three different discovery sites, a total of 97 mass graves, they found the mortal remains of 9,432 Ukrainians who had been murdered by the Soviets. No fewer than 14 commissions, 6 foreign ones

⁶¹¹ The 17-year-olds were 14 years old when the *Einsatzgruppen* advanced into Lithuania.

⁶¹² Auswärtiges Amt (ed.), *Amtliches Material zum Massenmord von Katyn*, Berlin 1943.

among them, examined the graves in the period from June 24 to August 25. In this case, too, the Germans publicized the results of the examinations in a substantial documentary study of 282 pages with 151 illustrations, forensic expert opinions, and identifications of the victims by names.⁶¹³

After the Soviets had retaken the area around Smolensk, they exhumed the bodies of Katyn a second time and summoned an investigative commission consisting exclusively of Soviet citizens (the Burdenko Commission), which then charged the Germans with the massacre. On January 15, 1944, this commission also invited in a group of Western journalists.

This attempt, heavily freighted with propaganda, at falsifying history is also betrayed by 38 dossiers of documents dealing with the Katyn case, which can be found today in the archives of the Russian Federation in Moscow.⁶¹⁴ At the Nuremberg Trial, where the Soviets brazenly blamed the Germans for the crime, the subject of Katyn came up at several sessions,⁶¹⁵ while the mass murder of Vinnitsa was mentioned only a single time, and then only tangentially, by the Bulgarian court doctor Marko A. Markov, a member of the Katyn investigative commission called by the Germans three years before.⁶¹⁶

In order to consign the crimes of Katyn and Vinnitsa to oblivion, or at least to suppress them, the Soviets carried out a thorough investigation of all crimes, actual or invented, which the Germans had committed in the territory reconquered by the Red Army. For this purpose, an investigative commission was established at literally every small town. Since the Soviets had learned from Katyn the enormous propaganda effect of pictures, these commissions photographed all mass graves and bodies found. If, however, the bodies were too few, then the Soviets resorted to the trick of photographing them several times from different angles in order to create the impression that their number was greater.

The case of Osarichi is especially telling for this manipulative technique.

On March 12, 1944, the commander of the 35th Infantry Division of the Wehrmacht, Lieutenant General Richter, ordered the White Russian populace of that area to be interned in two camps not far from the village of Osarichi. There was no infrastructure in these camps and those confined there had to hold out under the open sky until March 18, the day of their liberation. The German historian Hans-Heinrich Nolte reports:⁶¹⁷

⁶¹³ Auswärtiges Amt (ed.), *Amtliches Material zum Massenmord von Winniza*, Berlin 1944.

⁶¹⁴ GARF, 7021-114-1/38.

⁶¹⁵ Cf. for example IMT, Vol. VII, p. 425-428 (Conclusions of the Soviet Investigative Commission), and Document USSR-54. Cf. also Robert Faurisson, "Katyn à Nuremberg," *Revue d'Histoire Révisionniste*, August-September-October 1990, pp. 138-144.

⁶¹⁶ IMT, Vol. XVII, p. 357. Markov was interrogated by the Soviet Chief State Counsel Smirnov and gave the desired testimony, which was supposed to weaken the results of the German investigative commission.

⁶¹⁷ *Geiseln der Wehrmacht. Osaritschi, das Todeslager. Dokumente und Beleg*, National Ar-

“The camps were snatched up by Soviet propaganda; several newspaper articles reported on them. The ‘Extraordinary State Commission for the Determination of the Crimes of the German Fascist Conquerors’ dispatched an investigative group.”

Military correspondents, who took numerous photographs after the liberation of the two camps,⁶¹⁸ belonged to this investigative group. The numbers of victims bruited about by diverse Soviet commissions diverge wildly and range from 8,000,⁶¹⁹ over 9,000⁶²⁰ and up to 20,800,⁶²¹ 30,000,⁶²² 37,526,⁶²³ and even 49,000.⁶²⁴

600 bodies were supposedly discovered lying on the ground;⁶²⁵ moreover, a mass grave 100 m long and 1.5 to 2 m wide, in which “a large number of bodies” was lying, is supposed to have been discovered in Camp 1,⁶²⁶ but in another report it says that the prisoners were forced by the Germans⁶²⁷

“to dig enormous trenches of 6 × 3 × 2 m, in which 14 bodies that had been shot had already been thrown.”

The committee for the planning of a memorial monument to Osarichi maintained that the bodies had either been left lying on the ground or had been heaped up in open pits:⁶²⁸

“The dead were not buried: those who still lived had no strength for it. At first the guards forced them to throw or to stack the bodies into pits especially excavated for that purpose near the fence. But with each day there were more and more bodies, and they remained lying among the living.”

Thus, the bodies were neither removed nor concealed, but could be seen by anyone. When the Army photographers arrived at the scene, they certainly found an awful horrible tableau, yet not quite awful enough. The heart-rending sight was that of a group of seven bodies – four children and three adults – who were lying a short distance from one another on the ground. This sad find was excellently suited for purposes of propaganda, but the number of bodies was too small. Therefore the photographers resorted to a trick: they photographed the bodies from nine different angles, so that photos gave the impression that one was looking at several dozen corpses.⁶²⁹ A single body, which

chives of the Republic of Belarus, Minsk 1999 (book in Russian and German), p. 272.

⁶¹⁸ *Ibid.*, p. 14.

⁶¹⁹ *Ibid.*, p. 36.

⁶²⁰ *Ibid.*, p. 34.

⁶²¹ *Ibid.*, p. 146. Here it says that of 52,000 internees, 40% were killed.

⁶²² *Ibid.*, p. 154.

⁶²³ *Ibid.*, p. 38. Here it says that of 70,960 internees, 33,434 survived.

⁶²⁴ *Ibid.*, pp. 148-150. Here it says that of 70,000 internees, 70% died.

⁶²⁵ *Ibid.*, p. 50.

⁶²⁶ *Ibid.*, p. 34.

⁶²⁷ *Ibid.*, p. 44.

⁶²⁸ *Ibid.*, p. 8.

⁶²⁹ *Ibid.*, photos 1-8 and 11, photo documents on unnumbered pages.

was lying somewhat off to the side of the rest, was photographed four times.⁶³⁰ In four other photos, an additional seven bodies not far distant from the rest can be recognized.⁶³¹ In all, the first 15 photographs, which surely constitute the most terrible scenes to be found in the camp, show 15 bodies. Another horrible view was that of a ditch, only one end of which can be seen in the photo; it is essentially empty in the rear, and in the foreground are 7 or 8 bodies. The picture is a good fit for the 6 m × 3 m × 2 m pit previously described and shows 15 bodies.⁶³² A further 14 photos show a total of 16 bodies.⁶³³

Doubtless this photographic documentation is rather too meager to confirm the deaths of between 8,000 and 49,000 human beings or – in flat contradiction to those numbers – the presence of even 600 bodies on the camp property!

A no less typical case is Babi Yar. As we have already emphasized, an *Einsatzgruppen* report speaks of 33,771 Jews shot there. According to the *Encyclopedia of the Holocaust*, the bodies were exhumed and burned by a 327-man ‘Sonderkommando’ between August 18 and September 19, 1943.⁶³⁴

On November 9, 1944, Major Lavrenko, of the Commission for the Investigation of German Crimes in Kiev, questioned the Jewish witness Vladimir K. Davidov. The latter stated that on August 18, 1943, he, along with 99 other prisoners, for the most part also Jewish, had been selected from the Siretzki concentration camp 5 km from Kiev. The 100 prisoners were taken to Babi Yar and forced to dig up the bodies of the Jews shot in 1941. According to him, 70,000 bodies had been in the mass graves of Babi Yar. The prisoners had exhumed these and afterwards burned them on ‘ovens,’ which consisted of granite blocks – procured from the Jewish cemetery of Kiev – with train rails laid upon them. On these a layer of wood was piled and on top of this the bodies, so that an enormous stack of bodies 10 to 12 m high resulted! In the beginning there was merely a single ‘oven,’ but then 75 of them (literally seventy-five) were built.

The bones did not completely burn; they were ground up and tossed into the trenches, from which the bodies had been taken. The witness reports:

“On September 25 and 26,^[635] when the work was nearly finished, the construction of another oven was ordered, upon which we ourselves were sup-

⁶³⁰ *Ibid.*, photos 8-11.

⁶³¹ *Ibid.*, photos 12-15.

⁶³² *Ibid.*, photo 22.

⁶³³ *Ibid.*, photos 16-21, 22-26, 28, 31f. In Photo 18, “Leiche eines unbekanntes Mädchens”, a body laid out on straw is recognizable; its face is in an advanced state of decomposition. In the background one sees the first two beams of a wooden barracks. This photograph has nothing to do with Osarichi: in the first place, a body does not decay within one week in the still cold White Russian March (nearly all photographs show snow), and in the second place there were no barracks in the two camps of Osarichi.

⁶³⁴ *Encyclopedia of the Holocaust*, *op. cit.* (note 18), Vol. I, p. 134f.

⁶³⁵ The word “August” appears in the text, which however is an obvious error. Four lines later

posed to be cremated. We deduced this from the fact that there were no more corpses in Babi Yar, but we had built an oven nevertheless.”

In order to escape their own murder, Davidov and a number of his comrades (35 to 40) escaped during the night of September 29, in which attempt at least ten of them were killed.⁶³⁶

The *Black Book* of Ilya Ehrenburg and Vassili Grossman summarizes this witness testimony, but alters a few numbers.⁶³⁷ The statements made in the *Encyclopedia of the Holocaust* quite obviously have their origin in this source.

This Vladimir K. Davidov is apparently the only witness who claims to have participated in the cremation of bodies of Babi Yar. His tale is wholly unbelievable. The number of bodies – 70,000 – is more than double the number shot according to the event report, which in itself is already hugely excessive. The tale of the 10 to 12 m tall mountain of bodies is technically absurd, as we pointed out in the fourth chapter. The claim that 75 ‘ovens’ of the kind first described by the witness are supposed to have been built stands in contradiction to the number of victims given by him, since in that case there would have been (75 × 3,000 =) 225,000 bodies to be burned!

As for the date, the witness maintains that the cremation of the bodies was finished on September 25 or 26. On this day, the prisoners had built the last ‘oven’ for themselves. On September 26, the *Luftwaffe* took an aerial photograph of the area, in which Babi Yar was located. John Ball has published it with the following commentary:⁶³⁸

“Photo 2 – September 26th, 1943:

This photo was taken one week after the end of the supposed mass cremations in the ravine.^[639] If 33,000 people were exhumed and burned evidence of vehicles and foot traffic to supply the fuel should be evident in the area where the Jewish cemetery meets Babi Yar ravine, however there is no evidence of traffic either on the end of the narrow road that proceeds to the

September is mentioned in connection with the escape of the prisoners.

⁶³⁶ GARF, 7021-65-6.

⁶³⁷ I. Ehrenburg, V. Grossman, *Le Livre Noir*, *op. cit.* (note 24), pp. 80f. According to the *Black Book*, not 100 but 300 prisoners were employed in excavating the bodies; the ‘ovens’ held 2,000 bodies instead of 3,000; not 10 but 280 escapees were killed.

⁶³⁸ John Ball, *Air Photo Evidence*, *op. cit.* (note 101), p. 107. In G. Rudolf, *Air-Photo Evidence*, *ibid.* (p. 154), the photo has been replaced with one of higher resolution. The text now reads:

“This photo was taken when the supposed mass excavations with subsequent cremations in the ravine, which are said to have started around August 20, 1943, were just coming to an end. If 33,771 corpses were exhumed and burned on huge pyres (or even more, if more people were executed after September 1941, as is claimed), evidence of still smoking pyres, of massive soil movements, of vehicle and foot traffic to supply fuel should be evident in the area where the mass graves are said to have been located: in the ravine branches west of the Christian and Jewish cemeteries.”*

The asteriks points to a footnote referring the reader to Mattogno’s book on *The Einsatzgruppen* (Castle Hill Publishers, Uckfield 2018).

⁶³⁹ “Yar” is Russian for ravine.

ravine from the end of Melnik Street, or on the grass and shrubbery within or on the sides of the cemetery.”

Regarding an enlarged section of the same photograph, Ball writes:⁶⁴⁰

“Photo 3 – September 26th, 1943:

An enlargement reveals no evidence that 325 people were working in the ravine finishing the cremation of 33,000 bodies just one week earlier, for many truckloads of fuel would have had to be brought in, and there are no scars from vehicle traffic either on the grass and shrubs at the side of the Jewish cemetery or in the ravine where the bodies were supposedly burned.”

Ball deduces from this:⁶⁴⁰

“1943 air photos of Babi Yar ravine and the adjoining Jewish cemetery in Kiev reveal that neither the soil nor the vegetation is disturbed as would be expected if materials and fuel had been transported one week earlier to hundreds of workers who had dug up and burned tens of thousands of bodies in one month.”

These findings are all the more valuable since, according to the sole witness, the cremation of the bodies in Babi Yar is supposed to have been completed on September 25 or 26, corresponding to the same day or the day before the air photos were taken. The *Black Book* mentions an even later date:⁶⁴¹

“On September 28, when the work was just completed, the Germans ordered the prisoners to light the fire.”

According to the data specified in the fourth chapter, the cremation of 33,771 bodies would have required approximately 4,500 tons of firewood and approximately 430 tons of wood ashes and about 190 tons of human ashes would have been generated by the process. Moreover, several dozen tons of granite (gravestones and monuments) would have had to have been transported from the Jewish cemetery to Babi Yar and back again in order to construct the sup-

⁶⁴⁰ John Ball, *Air Photo Evidence, op. cit.* (note 101), p. 108. In G. Rudolf, *ibid.* (Photo 4, p. 156), the section enlargement has been replaced with one showing the area where, according to current orthodox consensus, the actions is said to have been. The text now reads:

“Orthodox historiography currently assumes that the first batch of 33,771 Jews killed in September 1941 were buried and later exhumed and cremated in the ravine section encircled with a dotted ellipse. Later on, several more batches of up to almost 100,000 more victims are said to have been driven into the ravine following a path indicated by the white arrows, leading to their mass burial and later exhumation and cremation in that area of the ravine (cf. Kruglov).”

And as a conclusion (*ibid.*):

“1943 air photos of Babi Yar Ravine reveal that neither the soil nor the vegetation is disturbed as would be expected on a massive scale, if mass graves for 33,771 or even up to – and more than – 100,000 victims had recently been excavated and pyres were burning up to that date, and if materials and many thousands of metric tons of fuel wood had been transported to the site.”

⁶⁴¹ I. Ehrenburg, V. Grossman, *Le Livre Noir, op. cit.* (note 24), p. 81.

ports for the 75 ‘ovens.’ If the claims put forward about Babi Yar were true, all of this would have had to leave behind unmistakable traces on the air photo of September 26, 1943.

After the Soviets had reconquered Kiev, an investigative commission made its way to Babi Yar and took some photographs, which were immortalized in an album. Three of the photos supposedly show a first and a second “zone where the bodies were burned.”⁶⁴² In another, the “remnants of the ovens and the grotto, into which the prisoners who had cremated the bodies had escaped” are allegedly shown.⁶⁴² The captions to these pictures are absurd; the only actual, clearly recognizable objects are a few rotted shoes and some rags, which were painstakingly photographed by the Soviets and described as follows:⁶⁴²

“Remnants of shoes and pieces of clothing from Soviet citizens shot by the Germans.”

Thus, the most important material evidence for the shooting of 33,771 (or 70,000) Jews, and the later excavation and cremation of their bodies, to be discovered by the Soviets at the scene of the crime consisted of a few shoes and some rags! If, however, the Soviets took such great pains to document things, which had no connection with the charges, what a propaganda circus would they have put on if they had really discovered mass graves with a total of far more than a million murdered Jews (as well as countless non-Jews)? Yet such a propaganda circus failed to occur, since the Soviets found nothing comparable to the discoveries made by the Germans in Katyn and Vinnitsa! The objection that they had not been in the position to locate the murder sites would be wholly untenable. Finally, the Germans, with the assistance of the civilian populace, had discovered 97 mass graves of murdered Ukrainians. As we saw in the third chapter, the Soviets pinpointed three mass graves and 13 individual graves in the area around Treblinka I, and the Poles found 41 mass graves of victims of an epidemic.

If, therefore – to take the number given by Raul Hilberg – the bodies of the barely one-and-a-half million Soviet Jews – killed chiefly by the *Einsatzgruppen*, but also by Wehrmacht, SS, police units, and Romanians – as well as of the countless non-Jewish victims were not able to be found, they must have been eliminated, *i.e.* cremated. For that reason, the legal system and historiography needed the ‘*Aktion 1005*’ (Operation 1005) or ‘*Sonderaktion 1005*’ (Special Operation 1005), about which we have written briefly in the fourth chapter. This is implicitly conceded even by the official historiography:⁶⁴³

“Although burning the bodies from the mass graves did not efface the Nazi crimes, it did cause difficulties in determining the facts of the crimes and in drawing up statistics on the numbers of victims. In many cases, the commissions investigating Nazi crimes in the USSR and in Poland found no

⁶⁴² GARF, 128-132. Photo album without pagination.

⁶⁴³ *Encyclopedia of the Holocaust*, *op. cit.* (note 18), p. 14.

trace of the mass graves, and they encountered difficulty in reaching estimates.”

In other words: material evidence for the mass murder of an enormous number of people, the ‘*corpus delicti*,’ was not found, but this is a mere ‘detail’!

If traces of mass graves are discovered after prolonged searches, no efforts are usually made to determine how many victims they contain, who the victims are and how they died. Here is an example. According to a report of December 1, 1941, of the Commander of the Security Police and the SD *Einsatzkommando* 3, the following persons were shot in Mariampole (Lithuanian: Mariyampol) on September 1, 1941:⁶⁴⁴

“1,763 Jews, 1,812 Jewesses, 1,404 Jewish children, 109 mentally ill, 1 German female national who had married a Jew, 1 Russian female.”

When a local initiative was launched in 1996 to build a memorial on site for these presumably murdered Jews, the responsible authorities wanted to find out first where exactly the victims had been buried. Excavations in places identified by witnesses were initially unsuccessful,⁶⁴⁵ but when the search was widened, this eventually resulted in a discovery of human remains which were assumed to be the victims. Further investigations were not conducted, however. The reason for this was explained by the archaeologist in charge, Dr. Algimantas Merkevičius:⁶⁴⁶

“The purpose was to find exact place of the graves. The supposed burial place was empty and I found the mass graves about 100 m outside of this supposed territory. People were killed and buried in a big ditch. But after finding the exact place, my work was over. I don’t know how [many] people were killed and how big the mass grave territory [is].”

This is a deplorable indifference on the part of those responsible who are not interested to determine the number and identity of the victims, their probable cause and time of death as well as their potential murderers, for this is all self-evident anyway.

Every time the Soviets discovered bodies of victims of the Germans, they photographed them, even in little-known places like the camp Siretzki in the Ukraine.⁶⁴⁷ In Auschwitz-Birkenau they found 536 bodies, which were all au-

⁶⁴⁴ RGVA, 500-1-25/1, p. 151.

⁶⁴⁵ *Lietuvos Rytas* (Litauen), 21.8.1996.

⁶⁴⁶ In einem Brief an Roberto Muehlenkamp vom 17.6.2003; http://holocaustcontroversies.blogspot.com/2006/04/thats-why-it-is-denial-not-revisionism_06.html (Zugriff am 13.4.2017).

⁶⁴⁷ GARF, 128-132, photo album without pagination. Three of the photographs show a few dozen bodies spread out on the ground, another permits a “ditch partly filled with bodies” to be recognized.

topsied.⁶⁴⁸ The dead were solemnly interred in the presence of numerous people. Photos were taken of this and many scenes were filmed.⁶⁴⁹

Let us now turn to the question of what the official historiography tells us about the alleged 'Operation 1005' and upon what sources this is based. An article in the *Encyclopedia of the Holocaust* states:⁶⁵⁰

"Operation 1005, code name for a large-scale activity that aimed to obliterate the traces of the murder of millions of human beings by the Nazis in occupied Europe."

The decision to begin this operation is supposed to have been made in Berlin at the beginning of 1942. A letter of February 20, 1942, from the chief of the Gestapo, Heinrich Müller, to Martin Luther of the Foreign Office,⁶⁵¹ in which the subject of the unsatisfactory burial of corpses is raised and which is supposed to have been written after Müller "had received an anonymous letter complaining about the corpses flooding the WARTHEGAU area," is cited as proof.⁶⁵² This letter bears the file designation "IV B 4 43/42 gRs (1005),"⁶⁵² and the alleged 'Operation 1005' is supposed to have gotten its name from this document!

But Alfred Streim, who cites the relevant letter based on first-hand knowledge, writes:

"On November 20, 1942, Himmler ordered SS-Gruppenführer Müller, Chief of Department IV in the RSHA, in writing (Zst. Dok. Slg. Ordner 3, Bl. 583): '...You must give me a guarantee that the bodies of these deceased Jews will either be burned or buried in every location, and that nowhere can anything else of any kind happen with these bodies...'"

He does not say that this letter bore the heading "IV B 4 43/42 gRs (1005)," does not assign to it the designation '1005,' and confines himself to the following comment:⁶⁵³

"The undertaking received – in accord with a nomenclature procedure of the RSHA – the designation '1005.'"

Thus, the letter in question dates from November 20, 1942, and not from February 20. This would mean that the designation '1005' for the operation would have been assigned a full five months after its start! On the other hand, in the letter the Jews are referred to as "dead," not 'shot' or 'killed.' Moreover, the

⁶⁴⁸ GARF, 7021-108-21. Collection of individual autopsy reports.

⁶⁴⁹ Cf. for this the photos in *KL Auschwitz*, *op. cit.* (note 470), pp. 228f.

⁶⁵⁰ *Encyclopedia of the Holocaust*, *op. cit.* (note 18), article "Aktion 1005," Vol. I, p. 11.

⁶⁵¹ According to C. Gerlach, this letter was written by Himmler to Müller! (*op. cit.* (note 418), p. 773.)

⁶⁵² Thomas Sandkühler, *Endlösung in Galizien. Der Judenmord in Ostpolen und die Rettungsinitiativen von Berthold Beitz 1941-1944*, Verlag H. J. V. Dietz Nachfolger, Bonn 1996, p. 277.

⁶⁵³ A. Streim, "Die Verbrechen der Einsatzgruppen in der Sowjetunion", in: A. Rückerl (ed.), *NS-Prozesse*, *op. cit.* (note 250), p. 78.

disposal of the bodies could take place by cremation *or burial*, which means that the Himmler letter need have no connection with the excavation and cremation of corpses of Jews who had been shot, and that what we are dealing with here is a primitive hoax.

According to official historiography,⁶⁵⁰ *SS-Standartenführer* Paul Blobel took charge of ‘Operation 1005’ and “The operation commenced in June 1942 with attempts to burn the corpses in the CHELMNO extermination camp.”⁶⁵⁰ In the initial phase, the bodies in the alleged eastern extermination camps are supposed to have been exhumed and cremated. We have dealt with this issue in detail in Chapter IV, in the prototypical case of Treblinka.

The second phase is supposed to have lasted from the beginning of June 1943 until the end of July 1944. During its course, the mass graves on Soviet and Polish territory are supposed to have been emptied and the traces of the massacres eradicated.

The *Encyclopedia of the Holocaust* shows a map with the most important locations, at which these activities are supposed to have transpired. It is a huge area, which extends from north to south across approximately 1,500 km (from the North Sea to the Black Sea) and from west to east across about 1,300 km (from west Poland to the German-Soviet front).⁶⁵⁴ Beginning with the camp Janowska at Lemberg, each region is supposed to have been assigned its own ‘*Sonderkommando* 1005,’ which consisted of officers of the *Sicherheitsdienst* (Security Service) and from the *Sicherheitspolizei* (SIPO, Security Police), of men from the *Ordnungspolizei* (regular police) and of dozens or hundreds of – mostly Jewish – prisoners, whose task was the hands-on accomplishment of the work. ‘*Sonderkommando* 1005-A’ and ‘*Sonderkommando* 1005-B’ are supposed to have been active in Kiev. Both, so it is said, were then transferred. ‘*Sonderkommando* 1005-Mitte’ supposedly began its work in Minsk. Other ‘*Sonderkommandos* 1005’ were allegedly deployed in Lithuania, in Estonia, in the Białystok district, in the General Gouvernement and in Yugoslavia.⁶⁵⁵

Now, if one considers that, according to the most comprehensive studies on this subject that exist, the *Einsatzgruppen* alone are supposed to have shot 2,200,000 people (Jews and non-Jews),⁶⁵⁶ that Wehrmacht, SS, and police units are also accused of hundreds of thousands of murders, and that – as already emphasized – neither the Soviets nor the Poles have found any mass graves with as many as a few thousand bodies, the ‘*Sonderkommandos* 1005’ must have exhumed and burned between one-and-a-half and three million bodies. This means that within a period of 13 months they had to have emp-

⁶⁵⁴ *Encyclopedia of the Holocaust*, *op. cit.* (note 18), article “Aktion 1005,” Vol. I, p. 12.

⁶⁵⁵ *Ibid.*, pp. 11-14.

⁶⁵⁶ H. Krausnick, Hans Heinrich Wilhelm, *Die Truppe des Weltanschauungskrieges*. Deutsche Verlags-Anstalt, Stuttgart 1981, p. 621.

tied thousands of graves at hundreds of locations, which were scattered over an enormous area – all of this without leaving behind any material or documentary traces!

Without thousands of maps, on which the graves were marked, it would quite obviously have been impossible to locate those thousands of mass graves in a territory of more than 1.2 million square kilometers, but no such maps are mentioned in even a single *Einsatzgruppe* report or any other document, or have any such maps ever been found among the German documents captured by the victors of World War II. And if – as the witnesses report – thousands of pyres were burning during the night despite blackout regulations, no Soviet reconnaissance plane discovered and photographed them – for otherwise the photographs would have been exploited at once for propaganda purposes.

Thomas Sandkühler plays this down:⁶⁵⁷

“Due to the extreme secrecy of the ‘Operation 1005,’ written sources on it are very rare.”

In other words, there are none! Sandkühler’s statement reflects the total embarrassment, which orthodox historians feel in the face of this outrage, while simultaneously serving up the customary stale explanation: the documents do not exist “due to the strict secrecy”! This *hypothesis* stands in glaring contrast to a *fact*, which Gerald Reitlinger describes:⁶⁵⁸

“The original series [of Einsatzgruppen reports] consisted of nearly two hundred reports with a circulation list of sixty to a hundred copies each. [...]

It is not easy to see why the murderers left such an abundant testimony behind them, [...]”

The Event Reports USSR comprise a total of “over 2,900 typewritten pages,”⁶⁵⁹ and each of them was distributed with a minimum circulation of 30 copies. The Germans are therefore supposed to have distributed tens of thousands of pages of documents concerning the mass shootings committed by the *Einsatzgruppen*, then quite suddenly have grasped the necessity of exhuming and burning the bodies, but have forgotten to destroy the incriminating documents!

In fact, the story of ‘Operation 1005’ is based upon several completely unreliable witness statements. The first of them were collected by Soviet commissions or journalists and printed in the *Black Book* edited by Ilya Ehrenburg and Wassili Grossman. This is a propagandistic collection of tales from alleged eyewitnesses. Aside from the Vladimir K. Davidov already mentioned, one finds here the (hearsay) testimony of Shimon Ariel and Zalma Edelman

⁶⁵⁷ T. Sandkühler, *op. cit.* (note 652), p. 278.

⁶⁵⁸ G. Reitlinger, *op. cit.* (note 180), p. 213.

⁶⁵⁹ H. Krausnick, H. H. Wilhelm, *op. cit.* (note 656), p. 333.

on Białystok,⁶⁶⁰ that of a few (according to their own statements) escapees from Kaunas,⁶⁶¹ and that of a Y. Farber on Ponari (Lithuania).⁶⁶² These witnesses know nothing to report about any ‘Operation 1005’ or a ‘Sonderkommando 1005.’

The designation ‘Sonderkommando 1005’ was invented by the Soviets. At the proceedings of February 9, 1946, at the Nuremberg Trial, Chief Counsel Smirnov read out excerpts from the protocol “of the interrogation of Gerhard Adametz (Exhibit USSR-80, Document Number USSR-80), taken by an American army lieutenant, Patrick McMahon,” in which there was talk of the activities of the “*Sonderkommando 1005-A*” and “*1005-B*.”⁶⁶³

In 1946, the work written by Leon Weliczker, *Brygada Śmierci* (The Death Brigade), the longest and most detailed witness report on the ‘Brigade 1005,’ appeared in Lodz, which Thomas Sandkühler, once again using polite understatement, evaluates as follows:⁶⁶⁴

“The horrifying notes of Weliczker have only insignificant evidentiary value.”

Or, to put it another way, they have none!

The *SS-Standartenführer* Paul Blobel was, however, unknown to this witness. He was connected to the ‘Operation 1005’ by an Erwin Schulz, who had been the leader of *Einsatzkommando V* of the *Einsatzgruppe C* of the *Sicherheitspolizei* from the beginning of the Russian campaign until September 1941 and served under *SS-Brigadeführer* Rasch. But Schulz did not know the name of the alleged huge operation for the excavation and cremation of the bodies, since this was first settled upon in 1947. On December 20, 1945, he stated:⁶⁶⁵

“About 1943 I learned during my activity as Chief of Department I of the RSHA that at this time the SS-Standartenführer Blobel had to render the mass graves of those who had been shot and liquidated in the territories to be evacuated by the Wehrmacht unrecognizable. If I recall correctly, the cover-name for these mass graves was ‘water sites.’”

Now all that remained was to put the individual parts together.

In November 1946, Rudolf Höss wrote in the Krakow prison:⁶⁶⁶

“Standartenführer Blobel had been authorized to seek out and obliterate all the mass graves in the whole of the eastern districts. His department was given the code number ‘1005.’”

⁶⁶⁰ I. Ehrenburg, V. Grossman, *Le Livre Noir*, *op. cit.* (note 24), pp. 434-439.

⁶⁶¹ *Ibid.*, pp. 634-636.

⁶⁶² *Ibid.*, pp. 827-851.

⁶⁶³ IMT, Vol. VII, pp. 593-596, Document USSR-80.

⁶⁶⁴ T. Sandkühler, *op. cit.* (note 652), p. 522.

⁶⁶⁵ NO-3841.

⁶⁶⁶ Rudolf Höss, *The Commandant of Auschwitz*, Phoenix Press, London 2000, p. 188. The relevant section was presented as Document NO-4498b in Nuremberg.

Finally, during the preliminary examinations of the trial against the *Einsatzgruppen*, which took place in Nuremberg from September 29, 1947, to February 12, 1948, Paul Blobel judged it expedient to ‘confess’ what had already become ‘facts determined by virtue of official authority’ for the prosecutors. In a ‘statutory declaration’ made at Nuremberg on June 6, 1947, he stated for the record:⁶⁶⁷

“In June 1941, I became Chief of Sonderkommando 4 A. This Sonderkommando was assigned to Einsatzgruppe C, the latter was under the command of Dr. Rasch. The special region assigned to me was located in the area of the 6th Army, which was commanded by Field Marshal von Reichenau. In January 1942, I was relieved as Chief of Sonderkommando 4 A and was transferred to Berlin for disciplinary reasons. I remained there for some time with no work. I was under the supervision of Department IV, under the former Gruppenführer Müller.

In the fall of 1942, I was given the mission as Müller’s deputy to drive into the occupied eastern territories and eradicate the traces of the mass graves which came about from the executions of the Einsatzgruppen. This was my mission up to the summer of 1944.”

The American inquisitors gave every appearance of being unsatisfied with this ‘confession’ and forced Blobel to give a further ‘statutory declaration.’ This time he expressed himself in more detail:⁶⁶⁸

“After I had been relieved from this assignment, I had to report in Berlin to SS Obergruppenführer Heydrich and Gruppenführer Müller and in June 1942 was entrusted by Gruppenführer Müller with the mission of eradicating the traces of executions of the Einsatzgruppen in the east. My orders were to report personally to the commander of the Sicherheitspolizei and SD and to orally pass on to them Müller’s order and to supervise its performance. This order was a secret Reich matter, and it was ordered by Müller that due to the strictest secrecy of this mission, no kind of written exchanges are to be permitted.”

This version, with the new date (“in June 1942” instead of “in the fall of 1942”) was elevated to the pivotal point of official historiography. That Blobel in neither of his two declarations spoke of an ‘Operation 1005’ or a ‘Sonderkommando 1005’ played no role, for these little gaps were naturally closed by the historians!

It should be well understood that we do not wish to claim by what has been said here that there was no opening of mass graves and cremation of bodies, any more than we are claiming that there were no shootings of Jews. But we very much question the enormous scale that the official historiography attributes to these occurrences.

⁶⁶⁷ NO-3842.

⁶⁶⁸ NO-3947.

5. The Fate of the Western Jews in the East

The western Jews deported into the occupied eastern territories did not share, at least in the beginning, the fate of the ‘Soviet Jews.’ Christopher R. Browning concedes:⁶⁶⁹

“By the very fact that Hitler decided to kill all Russian Jews,^[670] he broke through the vicious circle, which consisted of the fact that with every new military success a continually increasing number of Jews fell under German control. But the Jewish policy of the Nazis in the rest of Europe experienced thereby no direct alteration. They continued speaking of emigration, deportation, and plans for a future Jewish homeland.”

In the “General Report of October 16, 1941, to January 31, 1942,” already mentioned, there is a section on the topic “Jews from the Reich,” which notes:⁶⁷¹

“Since December 1940 [the correct year is 1941], transports of Jews have been arriving from the Reich at short intervals. Of these, 20,000 Jews were directed to Riga and 7,000 to Minsk. The first 10,000 Jews evacuated to Riga were accommodated partly in a provisional reception camp, partly in a newly established hut-camp in the vicinity of Riga. The remaining transports were at first sent into a detached section of the Riga ghetto.

The construction of the camp is being managed using all Jews fit for labor, so that in the spring all deported Jews who live through the winter can be sent to this camp.

Of the Jews from the Reich, only a small portion is fit for labor. Approximately 70-80% are women and children as well as old persons not able to work. The mortality figures are climbing all the time, with the unusually harsh winter also a factor.

The output of the few Jews from the Reich who are fit for work is satisfactory. As a work force they are more desirable than the Russian Jews on account of their German language and their relatively greater cleanliness. The adaptability is remarkable, with which the Jews attempt to shape their life to conform to their circumstances.

The present crowding together of the Jews into the minimum space in all ghettos naturally causes a greater danger of epidemics, which is most effectively countered by the employment of Jewish physicians. In special cases, Jews who have become contagiously ill have been isolated under the pretext of sending them to a Jewish old people’s home or hospital and then executed.”

⁶⁶⁹ Christopher R. Browning, “La décision concernant la solution finale,” in: *L’Allemagne nazie et le génocide juif*, op. cit. (note 252), p. 198.

⁶⁷⁰ As already stressed, there is no evidence of any kind for such a decision.

⁶⁷¹ RGVA, 500-4-92, p. 64.

In a letter of July 21, 1942, from *Reichskommissar* Lohse to the *Standartenführer* Siegert of the RSHA, it says regarding a “work training camp” in Latvia:⁶⁷²

“Of the Jews evacuated from the Reich there are at present still 400 in the camp and employed in transportation and excavation work. The rest of the Jews deported to Riga have been accommodated elsewhere.”

These western Jews were therefore by no means systematically killed, although the majority of them were unfit for labor. This is in striking contrast to the alleged mass liquidations described in the report on indigenous Jews in Latvia mentioned earlier.

No doubt, the natural mortality among these Jews was very high, and occasionally they also ran the danger of being killed, but a portion of them survived the war. On the fragmentary lists of names of the Jews deported from Kaunas and Riga to Stutthof in the summer of 1944, there are at least 959 German Jews. One of them, Berthold Neufeldt, was born on June 17, 1936;⁶⁷³ he therefore had been deported at the age of 5 or 6 and was still alive in the summer of 1944.

In addition, at least 102 survivors are known from the Jewish deportations from Theresienstadt to Riga of January 9, 1942, and 15 survivors of the deportation of January 15 of the same year, besides 40 from the deportation of September 1, 1942, to Estonian Raasiku. These Jews were liberated at the following locations:

Bergen-Belsen, Bratislava, Bromberg, Buchenwald, Burggraben, Bydhost, Dachau, Danzig, Gottendorf, Gottenhof, Hamburg, Jagala, Kaiserswald, Katowitz, Kaufering, Kieblasse, Kiel, Langenstein, Lauenburg, Libau, Magdeburg, Neuengamme, Neustadt, Raasiku, Raguhn, Riga, Sachsenhausen, Salaspis, Sophienwalde, Straßenhof, Stutthof, Terezin (Theresienstadt), Torun (Thorn). In addition, 7 survivors of the transport from Theresienstadt of November 16, 1941, to Minsk were liberated in Auschwitz, Bergen-Belsen, Dachau, Flossenbürg, and Theresienstadt.⁶⁷⁴ The transports had included not isolated individuals but entire groups who must have exhibited a certain strength, since for example in Magdeburg 5 Jews from the transport of January 15, 1942, and 5 from that of January 9 were liberated, as were 3 Jews from the transport of January 15 and 7 from that of January 9 in Buchenwald.

These people had also survived the catastrophic hygienic and sanitary conditions, which prevailed in the German camps in 1945. Thus, the number of those surviving in 1944 must have been significantly higher.

⁶⁷² RGVA, 504-2-8, p. 192.

⁶⁷³ AMS, I-IIB-10, p. 176.

⁶⁷⁴ These details are taken from the book already cited, M. Kárný, *Terezinská pametní kniha*, *op. cit.* (note 569), p. 569).

Chapter VIII: Indirect Transports of Jews to the Eastern Territories

1. The ‘Jewish Reservation’ of Lublin

In September of 1939, directly after the military collapse of Poland, a project was developed to create a reservation for Jews on conquered Polish territory, into which all Jews living under German control were supposed to be deported. The idea of establishing “a Jewish state near Krakow under German administration” was broached by Heydrich on September 22 in a conversation with Walter von Brauchitsch, the Supreme Commander of the Army, and then taken up by Alfred Rosenberg at a meeting on September 28 and 29 with the Gauleiters in the east. Rosenberg mentioned the plan to settle “the whole of Jewry” together with all undesirable elements “between Vistula and Bug.”

In an official speech on September 29, Heydrich spoke of the establishment of a “*Reichsghetto*” in the region east of Warsaw and Lublin.⁶⁷⁵ The Jewish reservation was to be set up in the zone south of Lublin, lying between the Vistula and the Bug. One of the most important railway junctions in that region was Nisko, and for that reason it was referred to as the Nisko Plan or Nisko Operation. The Jewish transports into that region began in October 1939 and went on until March 1940. On March 23, 1940, Göring ordered the cessation of all deportations into the General Gouvernement.

A total of approximately 34,520 Jews were deported from the Reich to the incorporated Polish territories,⁶⁷⁶ and 6,615 Viennese Jews were deported into the ‘Reservation.’⁶⁷⁷ Mainly because of its competition with the Madagascar Plan, upon which all hopes of the Reich for the solution of the Jewish problem were focused at that time, the project came to a standstill soon after it began. Nevertheless, further Polish Jews were resettled in the Lublin ‘Reservation’: 9,451 from the Radom district from August 14 to September 25, 1940,⁶⁷⁸

⁶⁷⁵ Seev Goshen, “Eichmann und die Nisko-Aktion im Oktober 1939”, in: *Viertelsjahrshefte für Zeitgeschichte*, 1981, pp. 78f.

⁶⁷⁶ Janina Kielboń, “Deportacja Żydów do dystryktu lubelskiego (1939-1943),” in: *Zeszyty Majdanka*, XIV, 1992, p. 73.

⁶⁷⁷ W. Benz (ed.), *op. cit.* (note 79), p. 76.

⁶⁷⁸ J. Kielboń, *op. cit.* (note 676), pp. 68f.

3,436 from the Krakow ghetto from November 29, 1940, to April 2, 1941.⁶⁷⁹ In addition, in 1940, 1,200 Jews were deported into that area from Stettin, 5,570 from prison camps, 5,250 from the Warsaw district, and 1,020 from Krakow. In 1941, 6,280 Jews were sent into the ‘Reservation’ from the incorporated Polish territories, 1,530 Jews from prison camps, 2,200 from the Warsaw district, and 2,520 from Krakow.⁶⁸⁰ Therefore, from 1939 to 1941, a total of approximately 79,600 Jews arrived in that zone. The transportation of western Jews into the Lublin district started again in March 1942, but this time within the framework of a new policy.

2. Transports of Jews into the Lublin District in 1942

At the beginning of 1942, the Germans began to concentrate the Polish Jews in the district of Lublin and then subsequently to deport them farther to the east in order to make room for the Jews from the *Altreich*, from the *Ostmark*, from Slovenia, and from the Protectorate. These evacuations were arranged by an office of the government of the General Gouvernement, the “*Hauptabteilung innere Verwaltung Abteilung Bevölkerungswesen und Fürsorge*” (Main Department of Internal Administration, Department of Population and Welfare), to which the sub-departmental manager Richard Türk as well as the local authorities delivered the corresponding reports.

One of the first of these reports dates from January 6, 1942, and concerns the “Evacuation of 2,000 Jews from Mielec.” There it says:⁶⁸¹

“1,000 Jews are coming to the administrative district of Hrubieszow, their final destination Hrubieszow station. 1,000 Jews are coming to the administrative district of Cholm; the destination of 400 of them is the Włodawa station, Parczew station is the final destination of 600. Date after which these places will be ready to accept them is January 15, 1942.”

The next report dealing with this transfer warned the authorities:⁶⁸²

“I am asking you to absolutely see to it that the Jews are received at the station of their destination and are properly directed to locations as determined by you; so that it does not happen, as it has in other cases, that the Jews arrive at their station of destination without supervision and are now dispersed all across the country.”

On January 21, 1942, the number of Jews being evacuated from Mielec was increased to 4,500.⁶⁸³ The evacuation began on March 11, 1942. The 4,500 Jews were distributed as follows:⁶⁸⁴

⁶⁷⁹ *Ibid.*, pp. 71f.

⁶⁸⁰ *Ibid.*, p. 73.

⁶⁸¹ Józef Kermisz, *Dokumenty i Materiały do dziejów okupacji niemieckiej w Polsce, Tom II, “Akce” i “Wysiedlenia,”* Warsaw-Lodz-Krakow 1946, p. 10.

⁶⁸² *Ibid.*, p. 11.

“1,500 to admin. dist. of Cholm, with the stations of destination being Włodawa and Parczew .

1,000 to admin. distr. Radzyn with station of destination Międzyrzec.

500 to the admin. dist. Zamość with destination station Susiec.

1,500 to the admin. dist. of Hrubieszow.”

The direct train to Parczew arrived there on March 13, 1942; 800 Jews were accommodated in Włodawa, 200 in Sosnowiec (or Sosnowica, a hamlet 35 km west of Włodawa). The evacuation of Jews from Mielec ended on March 16. The rest of the Jews were “accommodated in the Krakow district.”⁶⁸⁵

On February 9, 1942, the “resettlement of 1,500 Jews with the destination station Włodawa (900 Jews) and Parczew (600 Jews)” was announced. The directives of the government office charged with the resettlement, which were forwarded to the local authorities as supplements by *Oberlandesverwaltungsrat* (Senior provincial administrative counselor) Weirauch, prescribe the following:⁶⁸⁶

“The office of the District of Lublin, Department of Internal Administration and Department of Population and Welfare, remains responsible to me for seeing to it that the Jews, who are to settle in, get assigned sufficient lodging according to what is possible. The resettling Jews are to be allowed to take along their bedding. With respect to other baggage and household effects, 25 kg per person is allowed to be taken along. The Jews are to be medically monitored after their arrival in their new areas of settlement for 3 weeks. Every case, in which there is a suspicion of illness or typhus, is to be reported to the district physician without delay.”

On March 22, 1942, there was a resettlement of Jews from Bilgoraj to Tarnograd, a village 20 km south of that city. The report that deals with this it reads:⁶⁸⁷

“On March 22, 1942, an evacuation from Bilgoraj to Tarnograd of 57 Jewish families with a total of 221 persons took place. Each family received a vehicle in order to take along the necessary pieces of furniture and beds. The Polish police and the special services unit took care of control and supervision. The operation went as planned without mishaps. The evacuees were accommodated in Tarnograd on the same day.”

On March 17, 1942, Fritz Reuter, an employee of the Department of Population and Welfare of the Office of the General Gouvernement of the district of Lublin, wrote a note, in which he referred to a talk conducted on the previous

⁶⁸³ *Ibid.*, p. 14.

⁶⁸⁴ *Ibid.*, p. 27.

⁶⁸⁵ *Ibid.*, p. 28.

⁶⁸⁶ *Ibid.*, p. 15.

⁶⁸⁷ *Ibid.*, p. 46.

day with *SS-Hauptsturmführer* Hermann Höfle, the delegate for the resettlement of Jews in the Lublin district:⁶⁸⁸

"I arranged for a talk with Hstuf. Höfle for Monday, the 16th of March 1942, namely at 17:30 hours. In the course of the discussion the following was explained by Hstuf. Höfle:

It would be expedient to divide the transports of Jews to the Lublin district into employable and unemployable Jews at the station of origin. If it is not possible to make this distinction at the station of origin, it will be necessary for the division of the transport into unemployables and unemployables to be done at Lublin.

Unemployable Jews are all to come to Bezec [Bełżec], the outermost border station in the Zamosz district.

Hstuf. Höfle is thinking of building a large camp, in which the employable Jews can be registered in a file system according to their occupations and requested from there.

Piaski is being made Jew-free and will be the collection point for the Jews coming out of the Reich.

Trawnicki [Trawniki] for the present time is quartering no Jews.

H. asks where on the Dęblin-Trawnicki route 60,000 Jews can be unloaded. Informed about the Jewish transports now running as far as we are concerned, H. explained that of the 500 Jews arriving in Susiec, those who were unemployable could be sorted out and sent to Bezec. According to a teletype of the government of March 4, 1942, a Jewish transport, whose destination was the Trawnicki station, is rolling out of the Protectorate. These Jews are not unloaded in Trawnicki, but have been brought to Izbica. An inquiry of the Zamosz district, asking to be able to request 200 Jews from there for work, was answered in the affirmative by H.

In conclusion he stated that he could accept 4-5 transports daily, of 1,000 Jews with the destination station of Bezec. These Jews would go across the border and would never come back into the General Gouvernement."

This document is of capital significance for two reasons. First, Höfle was the deputy *Stabführer* (staff leader) of the SS and Police Chief for the Lublin district (Otto Globocnik). According to official historiography, he coordinated in this capacity "the construction of the extermination camp Belzec and the deportations to there from the Lublin district."⁶⁸⁹ Second, Bełżec is supposed to have started its homicidal activity subsequent to the talk reported, on March 17, 1942. According to official historiography, it was (like Treblinka, Sobibór, and Chełmno) a pure extermination camp, where there was no separation of those fit and those unfit for labor. Yet according to the cited document:

⁶⁸⁸ *Ibid.*, pp. 32f.

⁶⁸⁹ *Enzyklopädie des Holocaust, op. cit.* (note 100), Vol. 2, p. 619. Not included in the English edition *Encyclopedia of the Holocaust, op. cit.* (note 18).

A subdivision of the Jews into those able to work and those not able to work was planned. The Jews able to work should be used for labor assignments. Bełżec was supposed to become a camp, in which the Jews fit to work were “registered in a file system according to their occupation.” This does not conform in the least to a ‘pure extermination camp.’

The Jews unable to work were all supposed to go to Bełżec. The camp was supposed “to accept 4-5 transports daily, of 1,000 Jews with the destination station of Be[l]żec,” clearly Jews unable to work, who are deported “across the border” and are allowed never to return to the General Gouvernement. For that reason, Bełżec was designated as “the outermost border station in the Zamosz district.” This sentence makes sense only in connection with a resettlement beyond the border.

Piaski was supposed to become the “collection point for the Jews coming out of the Reich.” If one uses the road, it is another 24 km to Lublin, located to the northwest of Piaski, and 91 km to Bełżec. With the train, the distance to Bełżec is even greater (about 130 km). This contradicts the thesis, according to which Bełżec was a pure extermination camp, since in this case the collection point would have been the camp itself.

It was intended to unload 60,000 Jews at a point on the Dęblin-Trawniki route. The former locale is 76 km northwest of Lublin (in the direction of Warsaw); Trawniki is 13 km east of Piaski (which it serves as rail station) on the Lublin-Rejowiec-Chełm/Lublin-Bełżec railroad line (before the Rejowiec station, a junction of the rail line turns off south toward Bełżec). This project, too, fails to jibe with the claim that Bełżec is supposed to have been a pure extermination camp.

This fact is completely confirmed by a report of April 7, 1942. Its author is *SS-Hauptsturmführer* Richard Türk, director of the Department for Population and Welfare in the Office of the Governor of the Lublin district. The report refers to the month of March and contains a paragraph with the heading “Jewish Resettlement Operation of the SS and Police Chief,” in which Türk reports:

“The possibilities of accommodation were and are currently being discussed with the delegate of the SS and Police Chief, that is, restricted to those stretching along the Dęblin-Rejowiec-Belzec railway line. Alternative possibilities were determined.

Due to my proposal, there is a basic understanding that, to the same degree as Jews from the west are being settled here, local Jews are to be evacuated, if possible. The current situation of the settling movement is that approximately 6,000 were settled here from the Reich, approximately 7,500 have been evacuated from the district and 18,000 from the city of Lublin.

Individually, 3,400 have been evacuated from Piaski, Lublin district, and 2,000 Reich Jews have come in so far; 2,000 from Izbica, Krasnystaw dis-

trict, and 4,000 Reich Jews arriving in it; from Opole and Wawolbnica, Puławy district, 1,950 have been evacuated [...]”

The report later mentions the resettlement of Jews from Mielec and Bilgoraj, which has already been discussed, and makes clear that the majority of the evacuees were unfit for labor:⁶⁹⁰

“On March 13, ’42, the Cholm district received approximately 1,000 Jews, of whom 200 were accommodated in Sosnowica and 800 in Włodawa.

On March 14, 1942, Międzyrzec, Radzyn district, received 750 Jews. On March 16, ’42, the Hrubieszow district received 1,343 Jews, 843 of whom have been accommodated in Dubienka and 500 in Belz. The majority were women and children and only a minority of men fit for labor. On March 16, ’42, the Zamosz district received 500 Jews, all of whom have been lodged in Cieszanow.

On March 22, ’42, 57 Jewish families with 221 persons were shifted from Bilgoraj to Tarnograd.”

The influx of western Jews into the Lublin district began in the middle of March 1942. The first transports routed there departed from the Protectorate on March 11, 1942, from the *Altreich* on March 13, from Slovakia on March 27, from the *Ostmark* on April 9. The transports included numerous people unfit for labor, who were lodged in the villages of the district together with those able to work.

On April 12, 1942, the chairman of the Jewish Council in Lublin posted a letter to Jewish Social Self-Assistance in Krakow, in which the “numbers of those resettled in the individual towns” were given for Mielec:⁶⁹¹

<i>“Belz</i>	<i>460 persons</i>
<i>Cieszanów</i>	<i>465 persons</i>
<i>Dubienka</i>	<i>787 persons</i>
<i>Sosnowica</i>	<i>210 persons</i>
<i>Międzyrzec</i>	<i>740 persons</i>
<i>Włodawa</i>	<i>770 persons”</i>

The letter continues:

“In Izbica two transports arrived from the Protectorate with 1,000 persons.

In Izbica 1,871 arrived from the Rhineland.

In Piaski, Lu., 1,008 persons arrived from the Protectorate.

Moreover, in the last few days further transports arrived, the number of which varies between 2,500 and 3,000 persons. Yesterday he^[692] received an unofficial – at any rate so far unconfirmed – piece of news that a passenger train of 19 cars, which allegedly was traveling to Izbica and con-

⁶⁹⁰ *Faschismus – Getto – Massenmord, op. cit.* (note 289), p. 271.

⁶⁹¹ *Ibid.*, pp. 275f.

⁶⁹² Dr. Marek Alter, Advisor for Jewish Affairs to the Governor of the Lublin District.

tained evacuees from Vienna, was supposed to go past Lublin. So far nothing has been able to be determined from official sources. With regard to Lublin itself, an insignificant number of Jews has remained in the city up to now, who are supposed to be resettled from the city into its environs according to unofficial information."

On April 16, 1942, *Landkommissar* (provincial commissioner) Lubartów sent the following letter to the District Chief of the Lublin district:⁶⁹³

"Yesterday afternoon at 18:00 hours, without any prior announcement, another transport of approximately 800 Jews arrived. About half were women and children under 14 years of age. There were no men at all in the transport. The Jews were from Slovakia as well. On Monday and Wednesday, altogether over 1,600 Jews arrived, among them hardly any fit for work. 200 Jews were transported onward to Kamionka, 300 to Ostrow, 80 to Firlej."

On May 9, 1942, the *Landkommissar* informed the District Chief:⁶⁹⁴

"Re: Evacuation of Jews from Slovakia. As I already reported by telephone, the governor of the district for population and welfare informed me last Wednesday that on Thursday 1,000 Jews would be arriving from Slovakia; they would be transported farther in about 14 days. On Thursday, the 7th of May, the transport arrived here in the late evening; there were 841 persons, older men and women with children; 199 men were kept behind in Lublin. This transport was better equipped with baggage and food than the earlier ones. The direction of the evacuation from Lublin was under the control of SS-Obstf. Pohl, who was also present on the occasion of the evacuation of the local Jews on April 9. The Jews are at first lodged in the former high school. Whether and when the transport onward is to take place is not yet clear."

In another letter from May 13, 1942, one reads:⁶⁹⁵

"Herr District Chief of Cholm was present here personally yesterday and requested that those of the next transport, who are fit for labor also be sent to him, since he is in urgent need of a work force. Furthermore, he complained about the fact that the food supplied for the transport trains is always taken off in Lublin. I am asking that the food be sent along to Cholm with the next transports."

A similar complaint was also heard from the delegation of Rejowiec:⁶⁹⁵

"The delegation informed me that on April 17, '42, 2 transports of evacuees from Slovakia and the Protectorate arrived. The baggage of the evacuees has remained in Lublin, and the delegation requests that the baggage, which for the most part contains bed linens, be released."

⁶⁹³ J. Kermisz, *op. cit.* (note 681), p. 48.

⁶⁹⁴ *Faschismus – Getto – Massenmord*, *op. cit.* (note 289), p. 276.

⁶⁹⁵ J. Kermisz, *op. cit.* (note 681), p. 49.

In order to create room for the new arrivals, Polish Jews residing in the Lublin district were gradually deported farther east. These evacuations were initiated by the SS and Police Chief of Lublin in collaboration with the “Sub-Department of Population and Welfare” of the governor of the district of Lublin, on the proposal of the local authorities. For example, a certain Lenk, a subordinate of the district chief of Janów-Lubelski, wrote to the SS and Police Chief of Lublin:⁶⁹⁶

“I ask you to evacuate Jews in the following locations:

<i>Radomysl</i>	<i>500</i>
<i>Zaklikow</i>	<i>1,500</i>
<i>Annopol</i>	<i>500</i>
<i>Ulanow I</i>	<i>500</i>
<i>Modliborzyce</i>	<i>1,000</i>
<i>Janów-Lubelski</i>	<i>400</i>
<i>Krasnik</i>	<i>1,000”</i>

Lenk added:

“Only old people, unfit for labor, women and children might be included by these evacuation operations, and such men who are not employed at German positions. Craftsmen, however, might still remain here for the time being.”

On May 13, 1942, the district chief in Puławy sent a letter to the governor of the district of Lublin, which stated under Point 5:⁶⁹⁷

“In Opole the ghetto consists of Jews from Slovakia who were sent here a short time ago. All Slovakian Jews who are fit to work have for the most part already been procured for the above named projects. Therefore, in the Opole ghetto there is merely a remnant of old and sick Jews who are not employable.”

On May 19, the district chief of Lublin reported to the Sub-Department for Population and Welfare:⁶⁹⁸

“On the questionnaire of the 12th of this month I recommended, when opportunity arises, that the following Jews, whose evacuation is required first, be deported:

<i>Lubartów</i>	<i>2,737</i>
<i>Ostrow-City</i>	<i>3,062</i>
<i>Piaski</i>	<i>6,166</i>
<i>Bełżyce</i>	<i>3,639</i>
<i>Bychawa</i>	<i>2,733</i>
<i>Chodel</i>	<i>1,398</i>
	<i>19,735.”</i>

⁶⁹⁶ *Ibid.*, p. 54.

⁶⁹⁷ *Faschismus – Getto – Massenmord*, *op. cit.* (note 289), p. 438.

⁶⁹⁸ J. Kermisz, *op. cit.* (note 681), p. 53.

In a letter of May 22, the district chief of Hrubieszow stated:⁶⁹⁹

“The number and place of residence of those Jews whose evacuation appears to be necessary first, is as follows:

- 1) in Hrubieszow 5,690 Jews
- 2) " Uchanie 2,025 Jews
- 3) " Grabowiec 2,026 Jews
- 4) " Dubienka 2,907 Jews
- 5) " Belz 1,540 Jews.”

There is no doubt at all that these transfers were serving the purpose of creating room for the western Jews deported into the Lublin district. Later, the latter would then also be evacuated again in stages. A report of October 5, 1942, of the district chief in Lublin to the governor of the Lublin district sets out the following information regarding this:⁷⁰⁰

“Reference: Dispositions of August 18, 1942, and September 28, 1942

With regard to the above dispositions I am reporting that since the first of January 1942, 8,009 Jews from the Reich have been resettled into my district. 3,692 of these have already been resettled again. Expenditures or outlays have not been incurred due to these evacuations, the Piaski community merely put 400 vehicles at their disposal without cost for the transportation of the sick, children, and baggage.”

The 8,009 Jews mentioned were accommodated in the following locales according to this report:

- 1,200 Jews from Germany in Bełżyce
- 5,466 Jews from Germany in Piaski
- 54 Jews from Germany in Luszawa
- 652 Jews from Germany in Kamionka
- 125 Jews from Slovakia in Firlej
- 512 Jews from Slovakia in Ostrow Lub.

The German policy of resettlement of the Jews was also echoed in the German press. On October 17, 1942, an article appeared in the *Lemberger Zeitung* with the headline “The first Jew-free city in the GG” (GG = General Gouvernement), in which the following appeared:⁷⁰¹

“Lublin is the first city in the General Gouvernement, which has become Jew-free, and the process now begins of liberating the territories of the individual administrative districts from Jews, who were bringing the economic life of this nation into considerable disorder. The first district, which no longer has Jews, is Biala Podlaska. The process is carried out as follows: the district people determine some location as the area of residence for the Jews of the entire administrative district. In clearing up [their dis-

⁶⁹⁹ *Ibid.*, p. 55.

⁷⁰⁰ *Faschismus – Getto – Massenmord*, op. cit. (note 289), p. 336.

⁷⁰¹ *Lemberger Zeitung*, No. 246, 17 October 1942, p. 5.

trict], *the two districts of Biala Podlaska and Radzin have jointly selected one city as a Jewish living area, namely Międzyrzec. Since this place lies in the territory of the administrative district of Radzin, however, Biala Podlaska no longer has any Jews. [...] In order to bring about order in the part of the country around Lubatow [Lubartów], the district chief of Lublin-Land decided upon the ghetto of Lubatow as the Jewish residential area for the Jews of the communities of Tysmieniec, Uscimov, Firlej, Kami-onka, Luszawa, Lucka, Samokleski, Tarlo, and Ostrow as a city including Niemce. All Jews of the communities named must leave the communities no longer than 24 hours after publication of this police order of the district chief and set out for the Jewish living area of the city. The Jews who are found outside of Lubatow after that period has elapsed are punished with death. The Jewish Council of the city of Lubatow is under obligation to accommodate, to register, and if necessary provide room and board for the Jews moving to Lubatow from the above cited communities.*"

It is clear from this article that if an area was declared to be 'Jew-free,' this in no way had to mean the extermination of the Jewish population concerned!

3. Numerical Analysis of the Transports into the Lublin District

In an article published in 1992, the Polish historian Janina Kielboń drew a nearly complete picture of the deportation of Jews to the district of Lublin between 1939 and 1942.⁷⁰² We reproduce the data for 1942 in table form:

Date	From	To	Deportees
Mar. 11, 1942	Theresienstadt	Izbica	1,001
Mar. 13, 1942	Altreich (Germany proper)	Izbica	1,003
Mar. 17, 1942	Theresienstadt	Izbica	1,000
Mar. 19, 1942	Altreich	Izbica	1,000
Mar. 25, 1942	Altreich	Izbica	426
Mar. 27, 1942	Slovakia	Lublin	1,000
Mar. 27, 1942	Altreich	Izbica	1,008
Mar. 28, 1942	Altreich	Trawniki	985
Mar. 30, 1942	Slovakia	Lublin	1,000
Mar. 31, 1942	Slovakia	Lublin	1,003
Apr. 1, 1942	Theresienstadt	Piaski	1,000
Apr. 5, 1942	Slovakia	Lublin	1,495
Apr. 9, 1942	Vienna	Izbica	998
Apr. 12, 1942	Slovakia	Lubartów	1,040
Apr. 14, 1942	Slovakia	Lubartów	1,038

⁷⁰² J. Kielboń, *op. cit.* (note 676), pp. 61-91.

Date	From	To	Deportees
Apr. 14, 1942	Altreich	Trawniki	659
Apr. 16, 1942	Slovakia	Rejowiec	1,040
Apr. 18, 1942	Theresienstadt	Rejowiec	1,000
Apr. 20, 1942	Slovakia	Rejowiec	1,030
Apr. 22, 1942	Slovakia	Nałęczów	1,001
Apr. 22, 1942	Altreich	Izbica	949
Apr. 23, 1942	Theresienstadt	Lublin	1,000
Apr. 23, 1942	Altreich	Kraśniczyn	12
Apr. 25, 1942	Altreich	Izbica	175
Apr. 25, 1942	Altreich	Izbica	963
Apr. 25, 1942	Altreich	Izbica	856
Apr. 27, 1942	Theresienstadt	Lublin	1,000
Apr. 27, 1942	Slovakia	Nałęczów	1,251
Apr. 27, 1942	Vienna	Włodawa	998
Apr. 28, 1942	Theresienstadt	Zamość	1,000
Apr. 30, 1942	Theresienstadt	Zamość	1,000
May 5, 1942	Slovakia	Lubartów	1,040
May 6, 1942	Slovakia	Łuków	1,038
May 7, 1942	Slovakia	Łuków	1,040
May 8, 1942	Slovakia	Międzyrzec Podl.	1,001
May 9, 1942	Theresienstadt	Sobibór/Osowa	1,000
May 11, 1942	Slovakia	Chełm	1,001
May 12, 1942	Slovakia	Chełm	1,002
May 12, 1942	Vienna	Izbica	1,001
May 12, 1942	Altreich	Bełżyce	1,000
Apr 13, 1942	Slovakia	Dęblin	1,040
May 14, 1942	Slovakia	Dęblin	1,040
May 14, 1942	Vienna	Izbica	1,006
May 17, 1942	Theresienstadt	Lublin	1,000
May 17, 1942	Slovakia	Puławy	1,028
May 18, 1942	Slovakia	Nałęczów	1,025
May 19, 1942	Slovakia	Nałęczów	1,005
May 20, 1942	Slovakia	Puławy	1,001
May 23, 1942	Slovakia	Rejowiec	1,630
May 24, 1942	Slovakia	Rejowiec	1,022
May 25, 1942	Theresienstadt	Lublin	1,000
May 25, 1942	Slovakia	Rejowiec	1,000
May 26, 1942	Slovakia	Rejowiec	1,000
May 29, 1942	Slovakia	Izbica	1,052
May 30, 1942	Slovakia	Izbica	1,000
June 1, 1942	Slovakia	Sobibór	1,000
June 2, 1942	Slovakia	Sobibór	1,014
June 5, 1942	Vienna	Izbica	1,001
June 5, 1942	Slovakia	Sobibór	1,000
June 6, 1942	Slovakia	Sobibór	1,001
June 8, 1942	Slovakia	Sobibór	1,000

Date	From	To	Deportees
June 9, 1942	Slovakia	Sobibór	1,010
June 10, 1942	Prague	Ujazdów	1,000
June 11, 1942	Slovakia	Sobibór	1,000
June 12, 1942	Theresienstadt	Trawniki	1,000
June 12, 1942	Slovakia	Sobibór	1,000
June 13, 1942	Theresienstadt	Majdanek	1,000
June 13, 1942	Slovakia	Sobibór	1,000
June 14, 1942	Slovakia	Sobibór	1,000
June 14, 1942	Vienna	Sobibór	996
June 15, 1942	Altreich	Izbica	145
July 15, 1942	Altreich 1942	Izbica	13
Total:			69,084

According to the Korherr Report, the following evacuations of Jews from the territory of the Reich were carried out up to January 1, 1943:

from the Altreich (Germany proper) and Sudetenland:	100,516
from the Ostmark (Austria):	47,555
from the Protectorate (Bohemia and Moravia):	69,677
Total:	217,748. ⁷⁰³

A total of 87,193 Jews, broken down as follows, arrived in the *Altersghetto* (old age ghetto) of Theresienstadt: 33,249 from the Altreich, 14,222 from the Ostmark and 39,722 from the Protectorate.⁷⁰⁴

9,431 Jews were deported into the ghetto of Litzmannstadt (Łódź) from the Altreich, 5,002 from the Ostmark, and 5,000 from the Protectorate (Prague), a total therefore of 19,433 between October 16 and November 4, 1941.⁷⁰⁵

9,194 Jews were sent into the Lublin district from the Altreich (March 13 to July 15, 1942), 6,000 from the Ostmark (April 9 to June 14, 1942), and 14,001 from the Protectorate (March 11 to June 13, 1942), thus a total of 29,195.

Finally, 6,615 Jews came to Nisko and other zones of the General Gouvernement from the Ostmark between October 20, 1939, and March 12, 1941.⁷⁰⁶

This results in the following picture:

⁷⁰³ NO-5194, p. 9.

⁷⁰⁴ NO-5194, p. 10.

⁷⁰⁵ List of the new settlers. APL, PSZ 19, p. 195.

⁷⁰⁶ W. Benz, *Dimension des Völkermords*, op. cit. (note 79), p. 76.

	EVACUATION	THERESIEN- STADT	LITZMANN- STADT	GENERAL GOUVERNE- MENT	EASTERN TERRITORIES
Altreich:	100,516	33,249	9,431	9,194	48,642
Ostmark:	47,555	14,222	5,002	12,615	15,716
Protectorate:	69,677	39,722	5,000	14,001	10,954
Totals:	217,748	87,193	19,433	35,810	75,312

Therefore, of the 217,748 Jews evacuated, 35,810 came to the Lublin district and 75,312 to the eastern territories. Nearly half of the total – 106,626 Jews – were lodged in the ghettos of Theresienstadt and Litzmannstadt.

Do the deportations into the eastern territories and the Lublin district constitute the prelude to a policy of extermination? The transport lists cited permit us to answer the question with an unequivocal *no*. Even after the opening of the so-called eastern extermination camps, most transports were sent into regions, in which there were Jewish residential settlements. For example, after the commencement of operations in Bełżec, approximately 30 transports arrived in such areas. Similarly, between the opening of Sobibór and the arrival of the first transports in that camp (June 1, 1942), many transports reached these areas, and a further six after that date. Furthermore, after the opening of Sobibór, at least 20 transports had as their destination locales situated farther to the east of it. And not only that: after Treblinka began operations on July 23, 1942, at least 15 transports were headed for zones located farther eastward. It is valid to suggest that the direct transports to Minsk arrived first in Warsaw and ran over the Siedlce-Czeremcha-Wolkowusk line, so that they were traveling past Treblinka at a distance of approximately 80 km (Siedlce railway station) and about 140 km from Sobibór.

What purpose could it really serve to let Jews destined for extermination travel for several hundred kilometers past two ‘extermination camps’? And if these camps actually possessed the incredible killing capacity, which the official version of history attributes to them, why in the world, then, did dozens and dozens of transports take doomed Jews and have them settled in the district of Lublin instead of taking them directly into this camp?

4. Beginning of the Transports of Jews to Auschwitz

The first transports of Jews to Auschwitz that can be documented are to be seen within the framework of an extended program for the exploitation of the Jewish work force. Those transports came from France and Slovakia.⁷⁰⁷

⁷⁰⁷ In this section the author (Carlo Mattogno) summarizes the pertinent results of his study *Special Treatment in Auschwitz*, 2nd ed., Castle Hill Publishers, Uckfield, 2016, pp. 29-36, and adds some new elements. – See also Enrique Aynat, *Estudios sobre el “Holocaustio,”*

On September 16, 1942, Martin Luther, director of the German Department in the Foreign Ministry, sent a telegram to the German embassy in Bratislava (Pressburg) stating that “in the process of taking the measures for the final solution of the European Jewish problem” the Reich government was prepared to immediately send “20,000 young strong Slovakian Jews” to the east, where there existed “need for deployment of labor.”⁷⁰⁸ The Slovakian government accepted the German proposal “with eagerness,”⁷⁰⁹ and the preparations for the deportations could begin. The program for deporting the Jews was decided upon on March 13, 1942, and provided for the dispatching of 10 trains each to Auschwitz and Lublin according to the following scheme:⁷¹⁰

NO.	TRAIN NO.	DEPARTING	FROM	ARRIVING	DESTINATION
1	Da 66	3/25/1942	Poprad	3/26/1942	Auschwitz
2	Da 67	3/27/1942	Žilina	3/27/1942	Lublin
3	Da 68	3/27/1942	Lamač (Patrónka)	3/28/1942	Auschwitz
4	Da 69	3/29/1942	Sered	30/3/1942	Lublin
5	Da 70	3/30/1942	Nováky	3/31/1942	Lublin
6	Da 71	4/1/1942	Lamač	4/2/1942	Auschwitz
7	Da 72	4/2/1942	Poprad	4/3/1942	Auschwitz
8	Da 73	4/5/1942	Žilina	4/5/1942	Lublin
9	Da 74	4/7/1942	Nováky	4/8/1942	Lublin
10	Da 75	4/7/1942	Poprad	4/8/1942	Auschwitz
11	Da 76	4/8/1942	Sered	4/9/1942	Lublin
12	Da 77	4/11/1942	Žilina	4/11/1942	Lublin
13	Da 78	4/11/1942	Lamač	4/12/1942	Auschwitz
14	Da 79	4/13/1942	Poprad	4/14/1942	Auschwitz
15	Da 80	4/14/1942	Sered	4/15/1942	Lublin
16	Da 81	4/16/1942	Nováky	4/17/1942	Lublin
17	Da 82	4/17/1942	Poprad	4/18/1942	Auschwitz
18	Da 83	4/18/1942	Lamač	4/19/1942	Auschwitz
19	Da 84	4/20/1942	Poprad	4/21/1942	Auschwitz
20	Da 85	4/21/1942	Nováky	4/22/1942	Lublin

Each transport was supposed to consist of 1,000 persons.⁷¹¹

Valencia 1994.

⁷⁰⁸ T-1078.

⁷⁰⁹ NG-2586-J, p. 6.

⁷¹⁰ *Riešenie židovskej otázky na Slovensku (1939-1945). Dokumenty*, Part 2, Edícia Judaica Slovaca, Bratislava 1994, pp. 59f. Engel, Štefan, Lev Haas, Bedřich Steiner, *Tragédia slovenských Židov: Fotografie a dokumenty*, Dokumentačná akcia pri ÚSZNO, Bratislava 1949, p. 91 (reproduction of the transport plan). Dezider Tóth *et al.* (eds.), *Tragédia slovenských Židov. Fotografie a dokumenty*, Datei, Banská Bystrica 1992, p. 161 (reproduction of the transport plan from March 26 to April 7, 1942).

⁷¹¹ *Riešenie...*, *op. cit.* (note 710), pp. 38f.

As we have seen in the preceding section, the Jews included in the direct deportations to Lublin were distributed throughout the surrounding towns.

On April 29, 1942, the German embassy in Bratislava (Pressburg) sent the Slovakian government a verbal note containing the following:

“The Jews who have been transported out and those yet to be transported out of the territory of Slovakia into Reich territory will be coming into the General Gouvernement and into the occupied eastern territories after preparation and retraining for work assignment. The accommodation, feeding, clothing, and retraining of the Jews, including their relatives, is incurring expenses, which cannot presently be covered from the initially small labor output of the Jews, because the retraining bears results only after some time and because only a portion of the Jews who have been and who are going to be transported is capable of working.”

In order to cover these expenses, the Reich government required a sum of 500 Reichsmark per person of the Slovakian government.⁷¹²

On May 11, 1942, *SS-Hauptsturmführer* Dieter Wisliceny, Eichmann’s deputy in Slovakia, informed the Slovakian Minister of the Interior that, according to information from the RSHA, there was a possibility of intensifying the transports of Slovakian Jews to Auschwitz, but he qualified this with:⁷¹³

“However, these transports are allowed to contain only Jews and Jewesses who are fit for labor, no children.”

The proposal was not adopted, and for this reason all 19 Jewish transports from Slovakia in May 1942 went into the Lublin district.

A total of 57,752 Jews in 57 transports were deported from Slovakia in the year 1942. Of these, 38 transports, or a total of 39,006 persons, were brought to the Lublin district,⁷¹⁴ the 19 remaining transports comprising 18,746 persons were sent to Auschwitz.

The first transports of Jews from France are also to be seen within the framework of this program for the exploitation of the Jewish work force, since the first transports comprised exclusively Jews able to work. In March 1942, *SS-Hauptsturmführer* Theodor Dannecker, representative for Jewish affairs in France, reported that preparatory talks “with regard to the expulsion of approx. 5,000 Jews to the east” could be conducted with the French authorities. Dannecker made clear that those involved would have to be “male Jews able to work, not over 55 years of age.”⁷¹⁵ The mass deportation of the Jews living in France, but also of those in Holland and Belgium, was decided in June of 1942. At that time, the Germans were conducting first and foremost a policy for the exploitation of the Jewish labor force in Auschwitz, so that the prob-

⁷¹² *Ibid.*, p. 105.

⁷¹³ *Ibid.*, pp. 108f.

⁷¹⁴ According to the transport lists cited in the preceding section, the 38 transports into the Lublin District comprised a total of 39,899 persons.

⁷¹⁵ RF-1216.

lem of those who were unfit for work was only a peripheral one. On June 15, 1942, Dannecker wrote a note, in which he summarized the results of a talk conducted on the 11th of that month in Department IV B 4 of the RSHA:⁷¹⁶

“For military reasons, an expulsion of Jews from Germany into the eastern deportation area can no longer take place during the summer.

RFSS [Reichsführer SS = Himmler] has therefore ordered that greater numbers of Jews will be transferred either from the southeastern (Romania) or from the western occupied regions to KL Auschwitz for the purpose of performing work.

The basic condition is that the Jews (of both sexes) are to be between 16 and 40 years of age. 10% of the Jews sent along can be unfit for labor.”

On June 22, 1942, Eichmann wrote a letter to the legation counselor Franz Rademacher on the topic “Labor assignment of Jews from France, Belgium, and the Netherlands,” in which he explained:⁷¹⁷

“For the time being, it is planned to initially deport to the Auschwitz Camp approximately 40,000 Jews from the occupied French regions, 40,000 Jews from the Netherlands, and 10,000 Jews from Belgium in special trains running daily with 1,000 persons each, from mid-July or the beginning of August of this year.”

The search for persons to deport, according to Eichmann’s instructions to Rademacher, should be restricted first of all “to Jews fit for labor.”

On June 26, 1942, *SS-Hauptsturmführer* Dannecker wrote a circular on “Guidelines for the Evacuation of Jews.” The deportations were supposed to be restricted to “Jews able to work of both sexes from 16 to 45 years of age.” Under point 21 the guidelines prescribe the following:⁷¹⁸

“The following must be taken along by each person:

a) 1 pair of sturdy work boots, 2 pairs of socks, 2 shirts, 2 pairs of underpants, 1 work suit, 2 wool blankets, 2 sets of bedding (pillow cases and sheets), 1 bowl, 1 drinking cup, 1 spoon and 1 sweater, and also the toilet articles necessary.

b) Each Jew has to take a food supply with him for a 3-day march. Only 1 piece of baggage is allowed to be taken along (1 suitcase or backpack).”

Under points 6 and 7 are the instructions:

“A food supply for a total of 14 days (bread, flour, barley, beans etc. in bags) is to be added to the transport in a special freight car. [...]

One Jew, who is responsible for keeping order during the trip and for the cleaning of the car at the end of the trip, is to be in charge of each car. This Jew is to also bring cleaning materials with him.”

⁷¹⁶ CDJC, XXVI-29.

⁷¹⁷ NG-183.

⁷¹⁸ RF-1221.

In July, discussions started about the problem of the deportation of children. On July 10, Dannecker inquired at the RSHA as to

*“whether the children of the Jews being deported can be included in the deportation starting with perhaps the 10th^[719] transport.”*⁷²⁰

On July 21, 1942, Dannecker wrote in a note in reference to a telephone discussion of the day before:⁷²¹

“The question of the deportation of children was discussed with SS-Sturm-bannführer Eichmann. He decided that, as soon as transportation into the General Gouvernement is again possible, transports of children can start rolling. SS-Obersturmführer Nowak promised to make about 6 transports possible to the General Gouvernement at the end of August/beginning of September, which can contain Jews of every kind (also Jews unfit for work and old Jews).”

These six transports could not have had Auschwitz as a destination, for first of all Auschwitz was not located within the General Gouvernement but in the territory of the Reich (from the German point of view at that time), and second because during that period deportations to Auschwitz ran along a mountain route. Therefore the sentence “as soon as transportation into the General Gouvernement is again possible” cannot have referred to Auschwitz.

On August 13, 1942, SS-Sturm-bannführer Günther sent a telegram to the SS authorities in charge in Paris on the subject of “Transportation of Jews to Auschwitz. Deportation there of the Jewish children,” in which he informed them that the Jewish children could “gradually be deported to Auschwitz in the planned transports.”⁷²² Transports purely of children, however, would not be permissible. (This was clearly to prevent the enemy from exploiting this in propaganda.)

On the day after this, in accordance with these orders, a transport with 1,000 persons departed from France for Auschwitz, “among them for the first time children.”⁷²³

In conformance with the instructions cited above, the first trains to Auschwitz carried only Jews fit to work, who were then normally included in the camp’s inmate registry. The following table summarizes the data relating to the first 18 transports:⁷²⁴

⁷¹⁹ The 10th transport departed on July 24, 1942.

⁷²⁰ T-441.

⁷²¹ RF-1233.

⁷²² CJC, XXVb-126. A reproduction of the document can be found in E. Aynat, *op. cit.* (note 707), p. 87.

⁷²³ T-444.

⁷²⁴ The transports allegedly taken completely into the gas before July 4, 1942, are a pure invention. Cf. C. Mattogno, *op. cit.* (note 707), pp. 34-36.

DATE	DEPORTEES	ORIGIN
March 26	999	Slovakia
March 28	798	Slovakia
March 30	1,112	Compiègne
April 2	965	Slovakia
April 3	997	Slovakia
April 13	1,077	Slovakia
April 17	1,000	Slovakia
April 19	1,000	Slovakia
April 23	1,000	Slovakia
April 24	1,000	Slovakia
April 29	723	Slovakia
May 22	1,000	Lublin KL
June 7	1,000	Compiègne
June 20	659	Slovakia
June 24	999	Drancy
June 27	1,000	Pithiviers
June 30	1,038	Beaune-La R.
June 30	400	Lublin KL
Total:	16,767	

5. Auschwitz as a Transit Camp for Western Jews

On September 5, 1942, *SS-Untersturmführer* Horst Ahnert, member of the SIPO and of the SD in Paris, wrote a note on the “Evacuation of Jews,” which begins as follows:⁷²⁵

“At the beginning of July 1942, the Reichssicherheitshauptamt ordered that, for the purpose of the final solution of the Jewish problem, the transportation of Jews out of the territories occupied by Germany for the goal of labor assignment should be begun on a greater scale.”

On September 12, there was a meeting between Reich Minister Albert Speer, *SS-Obergruppenführer* Oswald Pohl, the director of the *SS-WVHA*, and other functionaries. On the following day, Pohl handed a detailed report to Himmler. The discussion had concentrated on four points, the first of which was the “Enlargement of the barracks-camp of Auschwitz as a result of the eastern migration.”

Pohl wrote on this point:⁷²⁶

“In this manner, Reichsminister Prof. Speer wants to guarantee the deployment at short notice of approximately 50,000 Jews fit for work in closed companies with existing possibilities for lodging. We will skim off

⁷²⁵ CDJC, XXVI-61.

⁷²⁶ Pohl Report to Himmler of 16 September 1942 on the subject: a) Armament work. b) Bomb damage. BAK, NS 19/14, pp. 131-133.

the labor force necessary for this purpose from the migration to the east, chiefly at Auschwitz, so that our existing company facilities are not disturbed in their output and their structure. The Jews destined for migration to the east will therefore have to interrupt their journey and perform armament work."

By "migration to the east" was meant the deportation of the Jews to the eastern territories. In this context the last sentence clearly means that the Jews who were not fit to work did not interrupt their journey, thus did not stop in Auschwitz, but continued onward. Where at least a portion of these people was sent emerges from a report, which *SS-Untersturmführer* Ahnert wrote about a meeting held on August 28, 1942, at Department IV B 4 of the RSHA. This meeting had been called for the purpose of discussing the Jewish problem and in particular the evacuation of Jews in foreign occupied territories, as well as to address transportation problems. The evacuation of Jews to the east was supposed to take place via Auschwitz. In regard to the points discussed, the report noted under point c):⁷²⁷

"Inclusion of blankets, shoes, and eating utensils for the transport participants. It was demanded by the commandant of the internment camp Auschwitz that the necessary blankets, work shoes, and eating utensils are absolutely to be included in the transports. Insofar as this has not been done so far, they are immediately to be sent on to the camp."

Point e) related to the purchase of barracks:

"SS-Obersturmbannführer Eichmann requested that the purchase of the barracks ordered by the Commander of the Security Police Den Haag be undertaken immediately. The camp is supposed to be set up in Russia. The transporting of the barracks can be handled so that in every train transport 3-5 barracks are carried along."

In the draft of an agreement between the Jewish Council of Slovakia and the *SS-Sonderstab SS Führungshauptamt* (SS special staff, SS administrative main office) about the exchange of Jews for various goods, the following request of the Jewish Council is mentioned:⁷²⁸

"No further deportations from the General Gouvernement and Auschwitz, 15 days after the conclusion of the agreement."

What could the deportation from Auschwitz mean if not the continuation of the migration to the east?

In a letter dated March 24, 1943, Gisi Fleischmann, a leading Zionist in Slovakia, wrote:⁷²⁹

⁷²⁷ Report of the *SS-Untersturmführer* Horst Ahnert of 1 September 1942. CDJC, XXVI-59.

⁷²⁸ Dov Weissmandel, *Min-hammetsar*, Emunah, New York 1950, Document 8 (outside of the text). The title of the book (*In Distress*) is taken from Psalm 118: 5.

⁷²⁹ *Ibid.*, Document 23 (outside of the text).

“These days, however, brought us the schlichtim [Deported People] reports, which justified a little hope that small remnants can still be found there. We received approximately 200 letters from Dęblin-Irena and Końskowala, Lublin district, where in addition to our Jews also Belgian Jews reside, who arrived there during the last weeks.”

But all of the transports leaving from Belgium up to the end of March 1943 had been taken to Auschwitz,⁷³⁰ so that the Belgian Jews to be found in Dęblin-Irena⁷³¹ and Końskowala – a village 6 km from Puławy – must have reached there from Auschwitz, in fact within the framework of the migration east previously described.

Other Jews were deported to the ghetto of Grodno (White Russia). They, too, had to have arrived there via Auschwitz. In a report entitled *“Warunki materialne bytu Żydów”* (Material living conditions of the Jews), from the second half of the year 1942, one reads in regard to the ghetto of Lodz:⁷³²

“There is a factor, which is causing the number of Jews to increase. This factor consists of the evacuations from the regions occupied by the Germans. Information about such evacuations arrives in succession. It is known that 23,000 Jews from Berlin, Vienna, and Prague have been transferred to Lodz; similar instances are also known in Warsaw; recently, a certain number of Jews was transferred from Belgium to Grodno.”

The documents just cited prove that a considerable portion of the Jewish population of western Europe (namely of France, Belgium, and the Netherlands) was deported to the east from the second half of 1942 on, and, in fact, via Auschwitz, which served as a transit camp. The immediate destination of these Jews was the General Gouvernement or Riga, from which the transports traveled farther on to the east.

This policy was still in effect on May 5, 1943. On that day *SS-Gruppenführer* Wilhelm Harster, commander of the Security Police and SD in Holland, wrote a note, in which he summarized the orders from the RSHA for the following months:⁷³³

“1.) General lines:

The RFSS desires that as many Jews as humanly possible be deported to the east in this year.

2.) The next trains to the east:

Since a new synthetic rubber plant, which was destroyed in the west by air attacks, is supposed to be built in Auschwitz, above all a maximum number

⁷³⁰ Serge Klarsfeld and Maxime Steinberg, *Mémorial de la déportation des Juifs de Belgique*, The Beate Klarsfeld Foundation, New York 1994, pp. 42-45.

⁷³¹ Irena is a suburb of Dęblin.

⁷³² Maria Tyszkowa, “Eksterminacja Żydów w latach 1941-1943. Dokumenty Biura Informacji i Propagandy KG AK w zbiorach oddziału rękopisów BUW,” in: *Biuletyn Żydowskiego Instytutu Historycznego w Polsce*, No. 4 (1964), 1992, p. 49.

⁷³³ T-544.

of Jews from the west is needed in the months of May and June. It was agreed that at first the Jews made available for transportation will be shipped, if possible by the first half of the month, by means of combining several trains; the Westerbork Camp [in Holland] is therefore being emptied quickly. The figure of 8,000 is the goal for the month of May. Train arrangements are being taken care of by the BdS, Den Haag, with the RSHA.

3.) *The Hertogenbusch Camp:*

Since the RSHA requires a further 15,000 Jews in June, the point in time at which the inmates of the Hertogenbusch Camp [in Holland] can also be called upon must be reached as quickly as possible.”

A report produced at the beginning of 1944 and delivered to the Warsaw Delegation – that is, the representation of the government-in-exile residing in London – states with respect to the Jewish population of the General Gouvernement in December 1943:⁷³⁴

“According to information received, at the end of December there were approximately 150,000 Jews on Polish territory, in legal groupings, half of them foreign Jews.”

Who could these “foreign Jews” on Polish territory be, if not western Jews processed into the General Gouvernement via Auschwitz?

6. Final Destination of Jews Deported to the East

The deportations of Jews to the east therefore took place in two stages: the Jews were first temporarily settled or lodged in transit camps, and then deported farther east. In view of the paucity of existing documentation, we cannot determine with certainty what the final destination of this deportation was, but there exist various pieces of evidence, which make it possible for us to draw plausible conclusions.

In the “Guidelines for handling of the Jewish question,” which go back to the summer of 1941, the following paragraph appears:⁷³⁵

“The goal is a transfer into ghettos with simultaneous separation of the sexes. The existence of numerous more or less closed Jewish communities in White Russia and in the Ukraine facilitates this task. For the rest, locations are to be chosen, which, due to pending work projects, make possible the full utilization of the Jewish labor force.”

On August 14, 1942, SS-Brigadeführer Otto Rasch, Leader of *Einsatzgruppe C*, proposed to Berlin the following solution of the Jewish problem:⁷³⁶

⁷³⁴ *Faschismus – Getto – Massenmord, op. cit.* (note 289), p. 286.

⁷³⁵ PS-212. IMT, Vol. XXV, p. 304.

⁷³⁶ The Chief of the Sicherheitspolizei and of the SD. Event Report USSR No. 52 of August 14, 1941. NO-4540.

“The surplus Jewish masses can be expended and put to excellent use particularly in the cultivation of the great Pripjet marshes and the marshes on the northern Dnieper as well as on the Volga.”

As already mentioned,⁷³⁷ in a letter to Gauleiter Arthur Greiser on September 18, 1941, Himmler wrote that, in accord with the wishes of the Führer, the Jews were supposed to have been transported out of the Altreich and the Protectorate “into the eastern territories newly incorporated into the Reich two years ago,” but merely “as a first stage,” in expectation of a deportation “still farther to the east.”

A secret telegram of November 9, 1941, sent by Lohse to Rosenberg, reads with regard to Riga that the

*“Jewish camps must be shifted considerably farther to the east.”*⁷³⁸

On the same day, Dr. Leibbrandt reiterated in a telegram to the *Reichskommissar* for the *Ostland*, Hinrich Lohse, that “with regard to the transports of Jews into the *Ostland*”:⁷³⁸

“Jews are coming farther eastward. Camps in Riga and Minsk are only temporary measures.”

There is no reason whatsoever to doubt that the evidence for a program of renewed deportation of the Jews to the east corresponds to the truth. This is incidentally confirmed by an article of October 16, 1942, in the *Israelitisches Wochenblatt für die Schweiz* (Jewish Weekly for Switzerland). The paper reported:⁷³⁹

“For some time there has been a trend toward dissolution of the ghettos in Poland. That was the case with Lublin, then it was Warsaw’s turn. It is not known how far the plan has being carried out already. The former residents of the ghetto are going farther to the east into occupied Russian territory; Jews from Germany were brought into the ghetto partly to take their place. [...] an eyewitness who was in Riga a short time ago and was able to flee, reports that 32,000 Jews are still in the ghetto of Riga now. Since the occupation, thousands of Jews have been killed. In the morning, the Jews are said to have to line up outside the city for forced labor. They are said to not receive salaries but only permissions for food supply. Compared to the rest of the populace, they are said to receive only severely short rations: they are said to receive only 100 g of bread daily and 2 kg of potatoes per week. Recently, transports of Jews from Belgium and other nations of western Europe were noted in Riga, which, however, immediately traveled on again toward unknown destinations. In the ghetto of Riga, so it is said, there were pogroms on the 30th of November and the 8th of December, to which a great many Jews fell victim.”

⁷³⁷ See Chapter VI.

⁷³⁸ GARF, 7445-2-145, p. 52.

⁷³⁹ *Israelitisches Wochenblatt für die Schweiz*, No. 42, October 16, 1942, pp. 10f.

On May 23, 1942, Karol Sidor, representative of the Republic of Slovakia at the Holy See, handed a note to Secretary of State Luigi Maglione concerning the solution of the Jewish question. It was dated May 8th of the same year and was the answer to a letter of November 12, 1941, prepared by the Holy See to request information on this subject. After an explanation of the reasons for the delayed answer, the note continued:⁷⁴⁰

“But in this period of time^[741] there was a silence about the solution of the Jewish question. Long negotiations dealing with the solution to the Jewish problem in Europe took place between the Slovakian and German governments, and the view was offered that the emigration of the Slovakian Jews represents only one component of a much larger overall program. In the near future, half a million Jews from [western and central] Europe will be sent to eastern Europe. Slovakia will be the first state whose Jewish inhabitants are taken by Germany. At the same time, the emigration of Jews from France (the occupied part), Holland, Belgium, the Protectorate, and Reich territory is supposed to follow. Hungary has also expressed its desire to send off 800,000 Jews, as the head of government, Dr. Kállay, said in his speech on April 20 of this year.

The Slovakian Jews are being accommodated at various locations in the area of Lublin, where they will definitely remain. The Aryan population will be evacuated from these territories, and an exclusively Jewish district with its own administration will arise in its place, where the Jews can live as a community and can secure their existence by their own labor. The families will stay together.”

In a speech in Bad Tölz, before SS-Junkers⁷⁴² on November 23, 1942, Himmler said:⁷⁴³

“The Jewish question in Europe has also completely changed. In a Reichstag speech the Führer once said: Should Jewry instigate an international war to the extermination of the Aryan peoples, then it is not the Aryan peoples who will be exterminated but Jewry. The Jew is evacuated from Germany; today he lives in the east and works on our roads, railroads, and so on. This process has been carried out consistently, but without cruelty.”

On November 18, 1943, in a speech given in Krakow before SS leaders and officials of the General Gouvernement, Himmler spoke of:

⁷⁴⁰ *Actes et documents du Saint Siègre relatifs à la seconde guerre mondiale. Le Saint Siègre et les victimes de la guerre. Janvier 1941-Décembre 1942*, Libreria Editrice Vaticana, Vatican City 1975, Vol. 8, pp. 542f.

⁷⁴¹ From November 1941 to January 1942.

⁷⁴² The Junkers were members of the German squirearchy, young noblemen who partook of a long tradition of military service. Translator's note.

⁷⁴³ Bradley F. Smith and Agnes Peterson (eds.), *Heinrich Himmler. Geheimreden 1933 bis 1943*, Propyläen Verlag, Frankfurt am Main 1974, p. 200.

*"[...] these 16 million foreign peoples, whose numbers were once made even larger by an enormous number of Jews, who of course now have emigrated or been brought to the east. [...]"*⁷⁴⁴

On December 16, 1943, in a speech in Weimar given before the commanders of the *Kriegsmarine* (German navy), Himmler maintained that:⁷⁴⁵

"Such and so many Jews were brought to the east. Migrations of peoples that we have given great names to in history have taken place at this breakneck speed. [...]"

On July 29, 1942, the Papal Nuncio in France, Monsignore Valerio Valeri, wrote from Vichy to the Secretary of State, Cardinal Luigi Maglione:⁷⁴⁶

"Around the twentieth of this month the occupation authorities in Paris, using the French police, arrested approximately 12,000 Jews. These were then for the most part temporarily interned in Vélodrome^[747] d'Hiver. The majority of these are non-Aryans of foreign origin, above all Poles, Czechs, etc., who are designated for deportation into the Ukraine."

On September 7, 1942, the "Kommandeur No. 12" of the *Einsatzkommando* 12 of *Einsatzgruppe* D in Kislovodsk, Ukraine, issued the following order:⁷⁴⁸

"To all Jews. For the purpose of settlement in the less populated regions of the Ukraine, all Jews who live in the city of Kislovodsk and those Jews who have no fixed residence are obliged to report on Wednesday, the 9th of September 1942, at 5 o'clock in the morning, Berlin time (6 o'clock according to Moscow time) to the freight train station.

Each Jew is to take along a package of 20 kg or under of food for 2 days. Additional food will be secured at the stations by the German authorities. It is suggested that only the most necessary things be taken along: valuables, money, clothing, and blankets. Each family is to seal up its apartment, and on the key a slip of paper should be fastened, on which the first name, family name, the occupation, and the address of the family members are stated. This key with the slip of paper is to be handed over to the German detachment at the freight station. Due to the difficulties in transportation, bringing freight over 20 kg and furniture is impossible. For better preparation and transportation, each family is to pack up and seal its property, its linens etc. and in doing so declare the name of the owner. The Kommandantur [headquarters] No. 12 is responsible for maintaining the materials in undamaged condition.

Whoever makes an attack on the property of these Jews or attempts to force his way into a Jewish apartment will be shot immediately.

⁷⁴⁴ *Ibid.*, p. 201. Originals: notes: NARA, RG 242, T-175, Roll 91, Frames 3195-3198; audio recording: NARA, Tape 242-193 and Tape 242-218.

⁷⁴⁵ *Ibid.*, p. 201. Original notes: NARA, RG 242, T-175, Roll 91, Frames 3331-3335.

⁷⁴⁶ *Actes et Documents...*, *op. cit.* (note 740), Vol. 8, p. 610.

⁷⁴⁷ Bicycle racing stadium.

⁷⁴⁸ USSR 1A.

Baptized Jews are also subject to evacuation.

Those families, in which one of the parents is a Jew but the other is a Russian, a Ukrainian, or member of another nationality, are not subject to evacuation.

Furthermore, members of mixed blood are not subject to emigration. A voluntary emigration of the families of mixed blood, of half-breeds of groups I and II, is to be carried out at further opportunity.

At the station, all Jews are to form into lines of 45 to 50, in which individual families are to stay together.

The assembly should be completed about 5:45 (Berlin time), 6:45 o'clock (Moscow time). The Jewish committee is responsible for the execution of this order according to plan. Those Jews who impede the execution of this order will be severely punished."

This decree dovetails very well with a general plan for the resettlement of the Jews and for the deportation of western Jews into the Ukraine.⁷⁴⁹

According to Radio Moscow, several thousand French Jews were resettled in the Ukraine. In its issue number 71 of April 1944, the Jewish underground paper *Notre Voix* had the following news to report:⁷⁵⁰

"Thank you! A news item that will delight all Jews of France was broadcast by Radio Moscow. Which of us does not have a brother, a sister, or relatives among those deported from Paris? And who will not feel profound joy when he thinks about the fact that 8,000 Parisian Jews have been rescued from death by the glorious Red Army! One of them told Radio Moscow how he had been saved from death, and likewise 8,000 other Parisian Jews. They were all in the Ukraine when the last Soviet offensive began, and the SS bandits wanted to shoot them before they left the country.

⁷⁴⁹ R. Hilberg claims the Jews of Kislovodsk were not transferred, but were shot (*op. cit.* (note 17), Vol. 3, p. 1315). But in his footnote 38 he refers to an extremely dubious source, namely the *Black Book* of I. Ehrenburg and V. Grossman (*op. cit.* (note 24)). In this book, in which propaganda outweighs truth many times over, the alleged massacre is mentioned by a supposed eyewitness, the Jewish journalist Moissei Samoilowitsch Evenson, whose statements are supposed to have been jotted down by another journalist, Viktor Chklovski (I. Ehrenburg, V. Grossman, *Le Livre Noir*, *op. cit.* (note 24), pp. 460f.). The Soviet Commission for the Investigation of German Crimes in the Stavropol Region claimed that on September 9, 1942, 2,000 Jews left the Kislovodsk railway station, but the train halted at a nearby site and the Jews were shot in an anti-tank ditch. Later, thousands of Jews from Essentuki were shot in the same trench. On July 10, 1943, it claimed, 6,300 bodies were found there. (GARF, 7445-2-93, pp. 31f.) But this sensational discovery left behind no documentary traces, and the alleged mass murder is not mentioned in any of the *Einsatzgruppen* reports. In the standard work by Helmut Krausnick and Hans-Heinrich Wilhelm (*op. cit.*, note 656), the name of the city of Kislovodsk surfaces only one time (p. 202), and even there not in connection with a shooting of Jews.

⁷⁵⁰ Reproduced in: Union des juifs pour la résistance et l'entraide (ed.), *La presse antiraciste sous l'occupation hitlérienne*, self-published, Paris 1950, p. 179. We are indebted to Jean-Marie Boisdefeu for sending a photocopy of this page.

But since they knew what fate was in store for them and since they had learned that the Soviet troops were no longer far away, the deported Jews decided to escape. They were immediately welcomed by the Red Army and are presently all in the Soviet Union. The heroic Red Army has thus once again earned a claim on the gratitude of the Jewish community of France.”

After the evacuation of the Jewish Council of Mielec, health cost arrears in the amount of 2,260.80 zlotys resulted. On June 22, 1942, the State Sanatorium and Nursing facility of Koberzyn demanded this sum from the chief of the district of Lublin. Inquiries were made, and on September 4, the SS and Police Chief reported

“that the Jewish Council was evacuated from Mielec to Russia.”

The exact location, however, no one knew.⁷⁵¹

On May 13, 1942, the District Chief of Puławy sent a report to the Governor of the Lublin district, in which it was stated:⁷⁵²

“In the period between May 6 to May 12 inclusive, 16,822 Jews were expelled from the Puławy district across the Bug by the directive of the SS and Police Chief.”

According to official historiography, these Jews were deported to Sobibór and murdered there. The Sobibór Camp was located some kilometers from the River Bug, which forms the border between Poland and the Ukraine. One could cross the Bug by the Włodawa-Tamaszouka road (about 15 km north of the camp) as well as by rail (the Brest-Litovsk line). There is no valid reason why these Jews should not actually have been transported across the Bug, all the more so as Sobibór is not mentioned at all in this report. The destination of Sobibór was by no means a secret one, and it surfaces, for example, in the following report of August 4, 1942, from the chief of the Radom district:⁷⁵³

“I am hereby reporting that 69 Jews have been transported by a Sonderdienstkommando [Special Service Unit] from Rzczywol to the Sobibor Camp of the SS and Police Chief in the Lublin district.”

If one considers the small number of deportees (69 persons), their place of origin (a location which was less than 80 km from Warsaw), as well as the fact that they had been mustered by a Special Service Unit, then this leads to the conclusion that they were skilled workers who were supposed to be employed in Sobibór as camp personnel.

Incidentally, it is known that on July 5, 1943, Himmler personally gave the following order:⁷⁵⁴

⁷⁵¹ J. Kermisz, *op. cit.* (note 681), pp. 35 and 39.

⁷⁵² *Faschismus – Getto – Massenmord, op. cit.* (note 289), p. 438.

⁷⁵³ J. Kermisz, *op. cit.* (note 681), p. 438.

⁷⁵⁴ Reproduction of the document in: Thomas (Tovi) Blatt: *Sobibor. The Forgotten Revolt. A Survivor's Report*. H.E.P., Issaquah, 1998, documentation without pagination. Cf. also Pohl's letter to Himmler of July 15 and the reply of the Office of the *Reichsführer-SS* of July 24, 1943, both on the subject “Transit Camp Sobibór”.

“The transit camp Sobibór is to be converted into a concentration camp. In the concentration camp a plant for the repair of captured munitions is to be established.”

This instruction, directed to officials who could not have been unclear about the actual character of the Sobibór Camp, was a Reich secret: for what reason should Himmler have used the expression *Durchgangslager* (transit camp)? In order to pull the wool over the eyes of his underlings – who knew all about it for a long time?

Deportations of Dutch Jews to Sobibór took place around the time of Himmler’s order: on July 2, a transport with 2,397 persons arrived, on July 9 another with 2,417.⁷⁵⁵ That Sobibór had the function of a transit camp also emerges from the statements of several former Dutch-Jewish deportees:

Cato Polak, deported on March 10, 1943, remained in Sobibór one or two hours and was then transferred to Lublin with 30 women and 12 men. They returned home to Holland by way of Trawniki – Auschwitz – Bergen-Belsen – Theresienstadt.⁷⁵⁶

Bertha Jansen-Ensel and Judith Eliazar, who had arrived in Sobibór on March 10, 1943, were likewise transferred to Lublin. Both returned to their homeland via Auschwitz. Although they had alluded to gas chambers and cremations, they declared:⁷⁵⁷

“Sobibor was no camp, rather a transit camp.”

Jules Schelvis, deported to Sobibór on June 1, 1943, was transferred to Trawniki three hours after his arrival there and returned to Holland via Auschwitz.⁷⁵⁸

Mirjam Penha-Blitz gave a statement that was summarized as follows:⁷⁵⁹

“Deported by train from Westerbork on March 10, 1943. Arrival in Sobibor about March 13, 1943 (via Birkenau – without a stop – to Sobibor).”

Four or five hours after arrival at the camp, the witness was deported to Lublin. Her return home occurred via Birkenau.

Sientje and Jetje Vetterman, sent to Sobibór on April 6, 1943, were sorted out together with 28 other women for work and transferred to Trawniki with them. They returned to the Netherlands by way of Auschwitz-Birkenau.⁷⁶⁰

Elias Alex Cohen, deported to Sobibór on March 17, 1943, spent only a few hours in the camp and was sent to Lublin with 35 other Jews.⁷⁶¹ Sophie Verduin, deported on March 10, 1943, was transferred to Lublin after a few

⁷⁵⁵ Het Nederlandsche Roode Kruis. Afwikkelingsbureau Concentratiekampen. Sobibór. ROD, c[23.62.]09, p. 1

⁷⁵⁶ *Ibid.*, ’s-Gravenhage, Nov. 4, 1945, Verklaring 49, ROD, c[23.62.]09, p. 10.

⁷⁵⁷ *Ibid.*, Verklaring 134, pp. 13f.

⁷⁵⁸ *Ibid.*, Verklaring 177, p. 15.

⁷⁵⁹ *Ibid.*, Verklaring 178, p. 16.

⁷⁶⁰ *Ibid.*, Verklaring 180, p. 17.

⁷⁶¹ *Ibid.*, Verklaring 186, p. 18.

hours; her return home to Holland took place by way of Auschwitz-Birkenau.⁷⁶²

Jozef Wins de Heer, deported on May 11, 1943, went from Sobibór to Dorohucza. He returned home to the Netherlands by way of Lublin-Majdanek.⁷⁶³

In a well-documented book, which was published in Dutch in 1993 and was later translated into German, Jules Schelvis writes that “in Sobibor, after the arrival of transports, the fresh work forces for Dorohucza” were “selected.”⁷⁶⁴ At Dorohucza, 5 km from Trawniki, was a labor camp where peat was cut. According to Schelvis, at least 700 Dutch Jews were transferred there directly after their arrival in Sobibór, but he claims that only two of them are supposed to have survived the war.⁷⁶⁴ There is certain knowledge of 171 of these persons – 147 men and 24 women – since they sent postcards home from Dorohucza.⁷⁶⁵

Dorohucza was only one of many Jewish labor camps, which overlay the Lublin district like a dense network. Edward Dziadosz and Józef Marszałek count no fewer than 110 of them.⁷⁶⁶ As can be gathered from the statements of former deportees summarized above, other Dutch Jews were transferred from Sobibór to Lublin and then onward to these labor camps. Schelvis has documented a total of 89 postcards sent by Dutch Jews from Sobibór, 171 from Dorohucza, 52 from Lublin and 9 from Upper Silesia.⁷⁶⁷

It also happened that a portion of the Jews fit to work were sorted out from the rail cars before the train reached its final destination. This was the case for a transport that departed Vienna on June 14, 1942. After the train had arrived in Lublin, 51 Jews between 15 and 50 years of age had to get off; the remaining 949 continued their trip to the “labor camp” Sobibór, where it took an hour to unload the train. The original destination of the trip had been Izbica.⁷⁶⁸

It is characteristic that nearly all the Dutch Jews, who had been transferred from Sobibór to another camp, returned home by way of Auschwitz-Birkenau; instead of being liquidated as bearers of top-secret knowledge, they survived even this ‘extermination camp.’

From what has been established here, it emerges that a portion of the Jews deported to the Lublin district were deported across the Bug into the Ukraine. Dutch, French, and Czech Jews reached Minsk.⁷⁶⁹ The deportation of Polish

⁷⁶² *Ibid.*, Verklaring 188, p. 19.

⁷⁶³ *Ibid.*, Verklaring 192, p. 20.

⁷⁶⁴ Jules Schelvis, *Vernichtungslager Sobibor*, Metropol Verlag, Berlin 1998, p. 137.

⁷⁶⁵ *Ibid.*, p. 140.

⁷⁶⁶ Edward Dziadosz, Józef Marszałek, “Wiezienia i obozy w dystrykcie lubelskim w latach 1939-1944,” in: *Zeszyty Majdanka*, III, 1969, pp. 109-120.

⁷⁶⁷ J. Schelvis, *op. cit.* (note 764), p. 160.

⁷⁶⁸ “Erfahrungsbericht” of the transport leader Josef Frischmann; *ibid.*, pp. 70f.

⁷⁶⁹ C. Gerlach, *op. cit.* (note 418), p. 761.

Jews to White Russia was, according to C. Gerlach, “extremely extensive”⁷⁷⁰ and they were “taken to Minsk by railway”.⁷⁷¹

7. Transfers into the District of Galicia

A further portion of the Jews deported to the Lublin district was shunted on to Galicia.

Some former French prisoners of war who had been interned in the front line POW camp *Stalag 325* at Rava-Russka (17 km from Bełżec on the road to Lemberg/Lviv), were questioned by Belgian researcher Jean-Marie Boisdefeu. They claimed to have seen western, mainly French, Jews in that zone.⁷⁷² As Boisdefeu stresses, declarations made by other prisoners of war in the year 1945 confirm this. Thus, one Paul Roser testified at Nuremberg:⁷⁷³

“The Germans had transformed the area of Lemberg-Rawa Ruska into a giant ghetto.”

A Dr. Guérin wrote:⁷⁷⁴

“The province, situated in gloomiest Galicia, on the border of the Ukraine, had been transformed into a giant ghetto, in which Jews deported from the whole of occupied Europe were staying. They were guarded by brutal Ukrainians, who were in the pay of the Germans.”

There was also a ghetto in Rava-Russka, where 18,000 Jews were living in the summer of 1942. Of these, 14,000 were allegedly murdered between December 7, 1942, and January 10, 1943, and another 2,000 sent into the ‘death factory’ of Bełżec.⁷⁷⁵ It is not clear why this ghetto still existed several months after the opening of Bełżec, which was all of 17 km away from it, and why the alleged 14,000 victims were not sent directly into the ‘death factory.’ Not to mention the fact that on November 10, 1942, the Rava-Russka ghetto officially became one of the numerous ‘Jewish residential districts’ of Galicia.⁷⁷⁶

Jews from Belgium, Holland, Germany, the Protectorate of Bohemia and Moravia, and Slovakia arrived also in the camp of Janowski at Lemberg.⁷⁷⁷ I. Hertz and Naftali Nacht report:⁷⁷⁸

⁷⁷⁰ *Ibid.*, p. 762.

⁷⁷¹ *Ibid.*, p. 763.

⁷⁷² Jean-Marie Boisdefeu, *La controverse sur l’extermination des Juifs par les Allemands, Tome 2: Réalités de la “solution finale”*, Vrij Historisch Onderzoek, Antwerp 1996, pp. 65-71; Jean-Marie Boisdefeu, *La controverse sur l’extermination des Juifs par les Allemands. Corrigenda et addenda*, Vrij Historisch Onderzoek, Antwerp 1998, pp. 10-18.

⁷⁷³ IMT, Vol. VI, p. 291.

⁷⁷⁴ Dr. Guérin, *Rawa Ruska*, Editions Oris, Paris 1945, p. 13.

⁷⁷⁵ Protocol of the Soviet Investigative Commission for Rava-Russka of September 26-30, 1944. GARF, 7021-67-78, pp. 138f.

⁷⁷⁶ See lists in Notes 796f., pp. 266.

⁷⁷⁷ P. Friedman, *Roads to Extinction. Essays on the Holocaust*, The Jewish Publication Society

“All trains with Jews from Brussels, Paris, and Amsterdam go through Rava-Russkaya. Transports from Tarnopol, Kolomyya, Sambor, Brezany, and other cities in the West Ukraine came to them.”

On July 22, 1941, East Galicia was incorporated into the General Gouvernement; on August 1 of the same year, the district of Galicia was established.

The massacres of Jews committed by Ukrainians and SS men in July 1941 in Lemberg and other Galician towns were to a great extent retaliations for the mass murders of Ukrainians committed by the Soviets between June 22 and July 2, 1941, before the retreat of the Red Army. In fact, in the eyes of the SS and the civilian population, the ‘Soviet Jews’ were regarded as responsible for the Communist acts of violence or at least considered accomplices of the perpetrators. The reports of the *Einsatzgruppen* furnish detailed examples of this. Here are some typical instances:⁷⁷⁹

“In Tarnopol 5,000 Ukrainians kidnapped, 2,000 murdered. As counter measures arrest operation initiated against Jewish intellectuals, who shared responsibility for the murder and besides were informers for the NKVD. Number estimated at about 1,000. On July 5, approximately 70 Jews rounded up by Ukrainians and shot. Another 20 Jews killed on the road by military and Ukrainians, as response to the murder of three soldiers who were found chained in jail, with tongues cut out and eyes gouged out.”

After the discovery of Soviet torture chambers, other Jews were shot in retaliatory measures. For example, after the discovery of the torture chamber in the courthouse of Tarnopol, the Germans reacted as follows:⁷⁸⁰

“The troops marching through who had the opportunity to see these atrocities, above all the bodies of the murdered German soldiers, killed all of the approximately 600 Jews and set their houses on fire.”

Even the massacre of (allegedly!) 33,771 Jews in Babi Yar at Kiev was represented as an act of punishment:⁷⁸¹

“The animosity of the Ukrainian populace against the Jews is extraordinarily great, since they hold them guilty of the explosions in Kiev. Also, they are seen as the carriers and agents of the NKVD, who have brought terror down upon the Ukrainian people. In retaliation for the arsons in Kiev, all Jews were arrested, and on September 29 and 30, 33,771 Jews were executed in total.”

In the entire district of Galicia in July 1941, approximately 10,000 Jews are supposed to have been shot, and another 20,000 up to December, but these

of America, New York and Philadelphia 1980, p. 305.

⁷⁷⁸ I. Ehrenburg, V. Grossman, *Le Livre Noir*, *op. cit.* (note 24), p. 213.

⁷⁷⁹ Event Report USSR No. 14 of July 6, 1941, PGVA, 500-2-229, pp. 5f.

⁷⁸⁰ Event Report USSR No. 28 of July 20, 1942, PGVA, 500-2-229, pp. 113f.

⁷⁸¹ Activity and Situation Report No. 6 of the *Einsatzgruppen* of the Sicherheitspolizei and of the SD in the USSR (Report period from October 1-31, 1941). RGVA, 500-1-25/1, p. 151.

figures are highly dubious. The claimed mass killings contradict, in particular, the anti-Jewish measures of the civilian government of Galicia, which had replaced the military administration on August 1, 1941.

Barely two weeks after the convening of the civilian government on August 14, 1941, units of the security police in Lemberg, Tarnopol, and Stanisław received an order from Colonel Worm with respect to the “Jewish compulsory labor camps,” which began as follows:⁷⁸²

“In nearly all the larger towns of the district of Galicia, prisoner of war camps are supposed to have been prepared by the Russians. They are supposed to be equipped with all necessary stock and are especially well suited for the establishment of Jewish compulsory labor camps. All existing camps are to be investigated and reported immediately. At the same time, the holding capacity and condition are to be determined.”

On September 20, forced labor was introduced in the entire district for Jews “from the end of their 14th year to 60.”⁷⁸³ On November 6, 1941, procedures and deadlines were set for the establishment of a Jewish quarter in Lemberg, the administration of which was entrusted to a Jewish Council of Elders. This was obliged to establish, without delay, an office of nutrition, a security office, a system of justice, a health department, a welfare office, a burial system, a housing office, and a Jewish cemetery.⁷⁸⁴

The first two ghettos were formed in November and December of 1941 in Tarnopol (approx. 18,000 Jews) and Stanisław (about 30,000 Jews).⁷⁸⁵

In January 1942, the Medical Bureau of the Jewish community in Lemberg was established. The Jewish Council described it as follows:⁷⁸⁶

“The Medical Bureau of the Jewish community is the central administration and office of control for the entire hygiene system of the Jewish population of the city of Lemberg.

Today it supports general outpatient clinics for adults, 1 children’s outpatient clinic with an infant welfare and mothers’ consultation office, 1 lung clinic, 1 first aid post, 1 general hospital with outpatient clinics and 1 hospital for chronic diseases, both with 250 beds each. The department for hygiene control (Physikat), which has just established 8 sanitation posts in the Jewish quarter, has the mission of checking and examining the sanitary

⁷⁸² RGVA, 1323-2-292b, pp. 158-158a.

⁷⁸³ “Announcement. Re: Compulsory Labor for the Jewish Population in the District of Galicia.” Reproduction of the document in: *Faschismus – Getto – Massenmord, op. cit.* (note 289), p. 228.

⁷⁸⁴ “Besprechung über die Bildung eines jüdischen Wohnbezirk in der Stadt Lemberg, unter dem Vorsitz des Governors”. Lemberg, November 6, 1941, DAL, R 35-2-155, pp. 33-36.

⁷⁸⁵ Tatiana Berenstein, “Eksterminacja ludności żydowskiej w dystrykcie Galicja (1941-1943),” in: *Biuletyn Żydowskiego Instytutu Historycznego w Polsce*, No. 61, 1967, p. 17.

⁷⁸⁶ “Mitteilungen des Judenrats in Lemberg für die Jüdische Gemeinde, Nr. 1. Jänner 1942”, p. 6 DAL, R 35-12-5-, p. 5.

condition of the apartments, yards, public places, alleys in the Jewish residential quarter, to issue instructions and orders, and even to impose penalties in the case of non-compliance.

Two hospitals for infectious diseases are being organized and will open shortly. Throughout the rayon [a Russian administrative district—ed.], 60 Jewish physicians and Jewish sanitary personnel have been delegated for the fighting of epidemics, and further doctors will be following them successively. In Kleparow and Zniesienie, 2 outpatient clinics for adults and in addition further outpatient clinics for children and pulmonary cases are being established in the Jewish quarter.

Finally, sanitation crews and ‘block doctors’ are being organized for the control and supervision of the hygienic situation for every 250 apartments.

The General Jewish Hospital at Kuszewiczagasse 5, with its departments for internal, surgical, gynecological, and pediatric diseases, for urology, laryngology, dermatological diseases, neurology, and the outpatient clinics affiliated with them, receives patients throughout the entire day. [...]

The children’s outpatient clinic at Schleichergasse 5 and Bernsteingasse 5, with its consultation and welfare services for mothers and health clinic, receives sick children up to 14 years of age all through the day. Distribution of milk supplies for infants is done only at Schleichergasse 5.”

At the beginning of June 1942, a large delousing facility for 1,500 persons per day, in which there was a boiler room, a hot air chamber, and steam heating facilities, was put in operation in the Lemberg Jewish quarter. The facility was intended for the Jews. By means of it

*“[...] the Jews who are resettled within the city are processed through in the shortest time.”*⁷⁸⁷

According to the Polish-Jewish author Aleksander Krugłow, between March 19 and December 8, 1942, 251,000 Jews in 71 trains were brought to Bełżec,⁷⁸⁸ a figure which corresponds to nearly half of the alleged total number of victims of that camp. As is well known, Bełżec is supposed to have been an extermination camp established especially for the Jews in this area. In a report of June 30, 1943, *SS-Gruppenführer* Fritz Katzmann stated that the “evacuation from the district of Galicia” had been in operation “since April 1942” and explained:⁷⁸⁹

“When the Senior SS and Police Chief intervened once again with his police regulation of November 10, 1942, concerning the formation of Jewish

⁷⁸⁷ “Fleckfiebergefahr in Lemberg gebannt. Neue Entwesungsanstalt – Täglich werden 1500 Personen durchgeschleust”, in: *Lemberger Zeitung*, July 9, 1942, p. 5

⁷⁸⁸ Aleksander Krugłow, “Deportacja ludności żydowskiej z dystryktu Galicja do obozu zagłady w Bełżcu w 1943 r.,” in: *Biuletyn Żydowskiego Instytutu Historycznego w Polsce*, No. 3 (151), 1989, p. 107.

⁷⁸⁹ L-018. IMT, Vol. XXXVII, p. 398.

residential districts, 254,989 Jews had already been evacuated or resettled.”

A few pages later he adds:

“In the meantime, further evacuation was energetically pursued, so that effective of June 23, 1943, all Jewish quarters could be dissolved. The district of Galicia is, therefore, free of Jews, aside from the Jews who are in the camps under control of the SS and Police Chief. The occasional Jews who were picked up were specially treated by the respective Ordnungspolizei and Gendarmerie men. A total of 434,329 Jews had emigrated up to June 27, 1943.”

At that point in time, there were still 21,156 Jews in 21 Jewish camps.⁷⁹⁰

T. Sandkühler interprets the expression “*aus- bzw. umgesiedelt*” as code words for “gassed or shot,”⁷⁹¹ but this is completely untenable, because the designation used by Katzmann for those who were shot is “*sonderbehandelt*” (specially treated), just as in the section cited above, as well as in the two following:⁷⁹²

“[...] in the process, the whole bunch of Jewish shirkers and anti-social riff-raff was caught and specially treated. [...] These Jews, too, were dealt a special treatment.”

On October 31, 1942, the “government district north *Einsatzkommando* 5th Komp. Pol. Rgt. 24,” stationed at Rava-Russka, reported:

- “8 Jews handled according to orders” with the reason given “escaped from transport train;”
- 20 Jews “arrested” with the reason given “left resettlement district without permission and jumped off transport trains;”
- 5 Jews “handed over to the SS-Sonderkommando Bełżec;”
- 1 Jew “evacuated;”
- “1,023 Jews were evacuated in Kamionka-Strumilowa on October 28, 1942. Thus Kam.-Strum. is free of Jews”⁷⁹³

In all likelihood the expression “handled according to orders” is to be understood to mean shooting. With respect to the other formulations: “evacuated” is not the same as “resettled,” and the two designations do not have the same meaning as “handed over to the SS-Sonderkommando.” Nonetheless the 1,023 ‘resettled’ Jews are regarded by orthodox historians as ‘gassed in Bełżec.’⁷⁹⁴ Finally, there is an indication that there was a ‘resettlement quarter’ in Rava-

⁷⁹⁰ IMT, Vol. XXXVII, p. 401.

⁷⁹¹ T. Sandkühler, *op. cit.* (note 652), p. 460.

⁷⁹² L-018. IMT, Vol. XXXVII, pp. 393f.

⁷⁹³ RGVA, 1323-2-292b, p. 29.

⁷⁹⁴ A. Kruglow, *op. cit.* (note 788, p. 106), speaks of 2,500 deported to Bełżec on October 28, 1942, while Y. Arad contents himself with “hundreds,” *op. cit.* (note 71), p. 385.

Russka even before a ‘Jewish residential district’ was established in the local ghetto.

The guidelines of the Jewish policy in the entire General Gouvernement were made known to the authorities of Lemberg by *Brigadeführer* Katzmann on August 6, 1942:⁷⁹⁵

“Brigadeführer [Brigadier General] Katzmann announced that within half a year there will no longer be any Jews at large in the General Gouvernement. The people are in part being evacuated, in part are taken to camps. Isolated Jews living in the country are killed by the Einsatzkommandos. Jews concentrated in the cities are in part liquidated in large operations, partly evacuated, partly collected in labor camps.”

These orders make a clear distinction between “evacuated,” “taken to camps,” and “killed” in the one case as well as “liquidated,” “evacuated,” and “collected into labor camps” in the other case. In no instance would “evacuated” allow anyone to understand it as synonymous for “killed” or “liquidated”; the expression is therefore to be taken quite literally.

It is unknown by what criteria the classification of the Jews into these three groups was performed and how large their respective percentages were, but it should be permissible to assume that the ‘Soviet Jews’ (*i.e.*, Jews that moved to eastern Poland after its annexation by the Soviet Union in 1939) as well as those Jews who had committed anti-German acts or who were suspected of such, were supposed to be liquidated. On October 28, 1942, *SS-Obergruppenführer* Friedrich Wilhelm Krüger, in his capacity as Senior SS and Police Chief in the General Gouvernement and Secretary of State for the Security Services, issued a “Police regulation concerning the formation of Jewish living quarters in the districts of Warsaw and Lublin,” by which the establishment of 14 Jewish residential districts was prescribed.⁷⁹⁶ Also included was the Konskowola area, in which, according to the Slovakian Zionist Gisi Fleischmann, Belgian Jews were found in March 1943 (who obviously had arrived there via Auschwitz).

On November 10, 1942, Krüger also ordered the establishment of 41 Jewish quarters in the districts of Radom, Krakow, and Galicia.⁷⁹⁷

⁷⁹⁵ DAL, R-35-12-42, p. 70.

⁷⁹⁶ *Verordnungsblatt für das Generalgouvernement*. Issued at Krakow, November 1, 1942. No. 94, p. 665: a) in the District of Warsaw in: city of Warsaw (ghetto), Kaluszyn (*Kreishauptmannschaft* Minsk), Sobolew (Administrative District Garwolin), Kossów (Administrative District Sokolow), Rembertów (Administrative District Warsaw-Land), Siedlce (Administrative District Siedlce); b) in the District of Lublin in: Łuków Parczew and Międzyrzec (Administrative District Radzyn), Włodawa (Administrative District Chom), Konskowola (Administrative District Puławy), Piaski (Administrative District Lublin-Land), Zaklików (Administrative District Krasnik), Izbica (Administrative District Krasnystaw).

⁷⁹⁷ *Verordnungsblatt für das Generalgouvernement* Issued at Krakow, November 14, 1942, No. 98, pp. 683f.: a) in the Radom District in: Sandowmierz (Administrative District Opatow), Szydłowice (Administrative District Radom), Radomsko (Administrative District Radomsko-

These measures are not compatible with a policy of extermination. If, as official historiography has it, the establishment of these Jewish residential districts was aimed at concentrating the Jews in order to be able to liquidate them more easily, then why did the Bełżec Camp, allegedly founded for the purpose of just this liquidation, terminate its 'extermination activity' in December of 1942, although 161,514 Jews were still living in the district of Galicia on December 31, 1942?⁷⁹⁸

8. National Socialist Policy of Resettlement of Jews in the East According to Demographer Eugene M. Kulischer

Our expositions in the preceding chapters of the National Socialist policy of Jewish resettlement in the east find enormously important support in the demographic studies of Professor Eugene M. Kulischer, who was a member of the International Labour Office in Montreal, Canada, during the Second World War. His book bears the title *The Displacement of Population in Europe*⁷⁹⁹ and was published in 1943. In compiling his notes, the author made use of the assistance of 24 institutions that he lists painstakingly.⁸⁰⁰

ko), Ujazd (Administrative District Tomaszów); b) in the Kraków district in: Przemysł (Administrative District Przemysł), Reichshof (Administrative District Reichshof), Tarnów (Administrative District Tarnów), Bochnia (Administrative District Kraków-Land), Kraków City (ghetto); c) in the District of Galicia in: Lemberg-City (ghetto), Bóbrka (Administrative District Lemberg-Land), Jaryczów Nowy (Administrative District Lemberg-Land), Gródek (Administrative District Lemberg-Land), Rudki (Administrative District Lemberg-Land), Jaworów (Lemberg-Land), Złoczów (Administrative District Lemberg-Land), Przemysłany (Administrative District Złoczów), Brody (Administrative District Złoczów), Rawa-Ruska (ghetto), Administrative District Rawa-Ruska, Lubaczów (Administrative District Rawa-Ruska), Busk (Administrative District Kamionka-Strumilowa), Sokal (Administrative District Kamionka-Strumilowa), Brzezany (ghetto), Administrative District Brzezany, Bukaczowce (Administrative District Brzezany), Podhajce (Administrative District Brzezany), Rohatyn (Administrative District Brzezany), Tarnopol (Administrative District Tarnopol), Skalat (Administrative District Tarnopol), Trembóla (Administrative District Tarnopol), Zborów (Administrative District Tarnopol), Zbaraz (Administrative District Tarnopol), Czortków (ghetto) Administrative District Czortków, Buczacz (Administrative District Czortków), Borszczów (Administrative District Czortków), Kopyczyńce (Administrative District Czortków), Tluste-City (Administrative District Czortków), Stanisław City (ghetto) Administrative District Stanisław Stryj City (Administrative District Stryj), Drohobycz (ghetto) Administrative District Drohobycz, Boryslaw (ghetto) Administrative District Drohobycz, Sambor (ghetto) Administrative District Sambor.

⁷⁹⁸ NO-5194, p. 11.

⁷⁹⁹ Eugene M. Kulischer, *The Displacement of Population in Europe*, International Labour Office, Montreal 1943.

⁸⁰⁰ *Ibid.*, p. 5: The American Friends Service, Philadelphia, Pennsylvania; the American Na-

Each of these institutions had at its disposal a dense network of channels of information in the various European nations, so that Kulischer was able to base his work upon the best existing sources. In his book, he devotes a highly interesting section to the problem of the expulsion and evacuation of Jews by the German government, which is written with scientific exactitude and is undergirded by a copious documentation. For this reason, this book constitutes probably the most reliable information about what Germany's enemies knew in 1943, despite all of the treacherous atrocity propaganda concerning the NS Jewish policy. With rare precision, Kulischer explains above all the beginning phases of this policy:⁸⁰¹

“Until the outbreak of war, emigration was ostensibly encouraged; Chancellor Hitler said that he would willingly give a thousand mark note to every Jew who would leave. In practice, however, less humane and more effective methods of promoting Jewish emigration were adopted. Life in Germany was made impossible for Jews in order to induce them to leave, and when they left they had to abandon almost all their property. At the same time, a moral obligation to receive the Jews was imposed on other nations.

With the extension of German conquests, the aims of Germany's Jewish policy were widened to embrace the ‘liberation of all Europe from the Jewish yoke’. Not only the deportation and segregation of the Jews, but also their extermination was an openly proclaimed objective of German policy.^[802] But the main factor which changed the character of the anti-Jewish measures lay in the changed conditions themselves. With the progress of the war, emigration possibilities became more and more restricted. On the other hand, Germany was now able to send the Jews to non-German territories under German control, so that as stimulated emigration declined, deportation increased. The Jews were either expelled to ‘purge’ a given

tional Red Cross, Washington; the American Jewish Joint Distribution Committee, New York; the American Jewish Committee Research Institute on Peace and Post-War Problems, New York; the Belgian Information Center, New York; the Board of Economic Warfare, Washington; the Central and Eastern European Planning Board, New York; the Czechoslovak Information Service, New York; the United States Department of Commerce, Washington; the Finnish Legation, Washington; the French Information Center, New York; the French National Committee, Delegation to the United States, New York; the Greek Office of Information, Washington; the Hias-Ica Emigration Association (Hicem), New York; the International Red Cross, Washington; the Institute of Jewish Affairs, New York; the Latvian Legation, Washington; the Lithuanian Consulate-General, New York; the Office of Population Research, Princeton, New Jersey; the ORT Economic Research Committee, New York; the Polish Information Center, New York; the Turkish Embassy, Washington; the Young Men's Christian Association, New York; the Royal Yugoslav Government Information Center, New York.

⁸⁰¹ *Ibid.*, p. 95.

⁸⁰² Directly after this, Kulischer speaks of “economic extermination,” which proves that he does not mean physical liquidation but rather disempowerment when using the term “extermination”.

country or city of its Jewish element, or they were concentrated in specific regions, cities or parts of cities to ‘purge’ the rest of the locality.

It must be emphasised that the wholesale and recurrent removal of Jews is at the same time an effective method of securing their economic extermination. There is no regard for their prospects of earning livelihood; on the contrary, the transfer is carried out in such a way as to make it impossible for the Jew to reorganise his economic life.” (Emphasis added)

One of the methods for the realization of this economic extermination was the following:⁸⁰³

“First they [the Jews] are sent to the General Gouvernement. Then the town in which they were settled is ‘purged’. In their new place of residence a ghetto is established. But even the ghetto does not give the Jews the security of a permanent residence, and they are again removed further east.”

Kulischer then presents a little-known historical fact, which found its confirmation decades later:

“In many cases the immediate motive for expulsion or deportation was to make room for Germans. The first victims of expulsion on a grand scale were the Jews of the incorporated western Polish provinces, who were expelled along with the Polish inhabitants, in both cases to make room for the ‘repatriated’ Germans. Later, Jews were deported because, according to the official statements, they owned apartments suitable for refugees from cities subject to air-raids.”

In fact, Peter Witte has cited several examples of this German policy – approved by Hitler himself.⁸⁰⁴

Afterwards Kulischer dedicates much space to the “Countries and Territories of Expulsion and Deportation” and furnishes figures, some of which exceed, others of which are below, but all of which fall within the same order of magnitude as those of the Korherr Report. For example, for the period up until the end of December 1942, he assumes 120,000 Jewish deportees from the territory of the Reich⁸⁰⁵ (compared to 100,516 given in the Korherr Report); for Austria he speaks of 40,000⁸⁰⁵ (compared to Korherr’s 47,555), for the Protectorate of Bohemia and Moravia of 50,000 to 60,000⁸⁰⁵ (compared to 69,677 in Korherr) and of 62,444 for Slovakia⁸⁰⁶ (compared to Korherr’s figure of 56,691).

On France, Kulischer writes:⁸⁰⁷

⁸⁰³ *Ibid.*, p. 96.

⁸⁰⁴ Peter Witte, *op. cit.* (note 549), pp. 43-46.

⁸⁰⁵ Eugene Kulischer, *op. cit.* (note 799), p. 101.

⁸⁰⁶ *Ibid.*, p. 102.

⁸⁰⁷ *Ibid.* Kulischer overestimates the number of the Jews deported from France up to the summer of 1943: he speaks of 70,000, while the actual figure was approximately 54,000. (Serge Klarsfeld, *Mémorial de la Déportation des Juifs de France*, Paris 1978.)

“In midsummer 1942 a drive against foreign Jewish refugees in Paris marked the beginning of mass deportation from France to the ghettos and concentration camps of eastern Europe.”

Regarding Belgium, he stresses:⁸⁰⁸

“In the summer of 1942 deportation was resumed and from October onward it was on a larger scale. It may be estimated that up to December 1942 about 25,000 foreign Jews had been deported from Belgium, partly to eastern Europe and partly to France for fortification building.”

On Romania, he cites the *Krakauer Zeitung* (Krakow Times) of August 13, 1942:⁸⁰⁹

“According to a German source, ‘185,000 Jews have been evacuated since October of last year (i.e. 1941) into Transnistria, where they were housed in large ghettos until an opportunity arose for their removal further east. Today there still remain 272,409 Jews in the country... Both the provinces of Bessarabia and Bukovina can now be considered as free of Jews, excepting Czernowitz, where there are still about 16,000... It may be assumed that even during the present year a further 80,000 Jews could be removed to the eastern territories’. However, according to later reports, the Rumanian Government announced in October 1942 that there would be no more ‘evacuations’ to Transnistria.”

Kulischer subsequently devotes a section to the question of the “Territories of Destination and Methods of Confinement.” He stresses in particular the basic principle of the deportations of Jews:⁸¹⁰

“Some of the Jews from Belgium were sent to a neighbouring part of Western Europe for forced labour, but generally speaking the tendency has been to remove the Jews to the east. Many Western European Jews were reported to have been sent to the mines of Silesia. The great majority were sent to the General Government and, in ever growing numbers, to the eastern area, that is, to the territories which had been under Soviet rule since September 1939 and to the other occupied areas of the Soviet Union. During the early period, deportation meant removal to the General Government, but since 1940 the deported Jews have tended more and more to be sent exclusively to ghettos and labour camps.”

Kulischer then moves on to the ghettos:⁸¹¹

“The first ghettos were set up in Lodz in the winter 1939-1940. Since spring 1940 they have been introduced in a number of cities and towns in the Warthegau and the General Government. In the summer of 1940 the Germans segregated the district of Warsaw inhabited mainly by Jews un-

⁸⁰⁸ E. Kulischer, *ibid.*, p. 104.

⁸⁰⁹ *Ibid.*, p. 106.

⁸¹⁰ *Ibid.*, p. 107.

⁸¹¹ *Ibid.*, pp. 107f.

der the pretext that it was a breeding-place of contagious diseases, and in the autumn of the same year a ghetto was formally established. All Jews living outside its confines were ordered to move into the ghetto and all Poles living inside to leave the ghetto area. Many Jews were also brought there from abroad. In the first half of 1942 about 500,000 persons were crowded into the Warsaw ghetto.

The growth of the ghettos is illustrated by the following estimates. In November 1941 the Institute of Jewish Affairs estimated the number of Jews confined in the ghettos 'at no less than 1,000,000'. In December 1941 figures released by Polish Jewish circles in London showed that about 1,300,000 Jews had been herded into eleven ghettos in various parts of the country. For the early summer 1942 the Institute of Jewish Affairs gave the number as 1,500,000. On October 28 and November 10, 1942, the Secretary of State for Security in the General Government issued regulations about Jewish ghettos in the five districts of the General Government (Warsaw, Lublin, Krakow, Radom and Galicia), proving that from November 30, 1942, all General Government Jews must live in confined areas. Jews employed in armament and other war industries and living in closed camps are exempted. The confined areas are of two kinds: ghettos inside the larger towns, and purely Jewish towns, cleared of their non-Jewish population. In the whole of the General Government there are 13 ghettos, the largest being the Warsaw ghetto, and 42 Jewish towns.

Since the invasion of the U.S.S.R., ghettos have been established in western Biorussia, western Ukraine and Baltic States, and also in occupied Russia.

The primary purpose of the ghettos and special Jewish towns is the segregation of the local Jewish population. This consists of the former inhabitants of the area which was turned into a ghetto or a Jewish town, the inhabitants of the same town who are removed to the ghetto, and Jews removed from other localities of the same country. For the second and third categories segregation in the ghetto meant compulsory removal, and for the third category forced migration also. The number of persons affected by this internal forced migration may have numbered many hundreds of thousands in the General Government alone.

The ghettos of the General Government or the eastern territories are also the usual destination of the Jews deported from the west by the German authorities or by the authorities of other countries allied to Germany."

Finally, Kulischer comes to the subject of the compulsory labor camps. He notes in this regard:⁸¹²

⁸¹² *Ibid.*, p. 110.

“Up to the summer of 1941, at least 85 Jewish labour camps were known to exist in the General Government. Of the 35 camps the position of which was known, two-thirds were located on the eastern frontier.

Forced labour for Jews expanded rapidly, having developed from a subsidiary measure into an essential feature of the treatment of Jews. [...]

During 1942, forced labour became the common fate of the Jews in Poland and German-occupied Soviet territory. The period for which Jews fit to work are liable for forced labour is no longer limited. Their removal to the east was largely motivated by the wish to make use of them as forced labour, and as Germany’s need of manpower grew, deportation for adults of working age was tantamount to assignment to forced labour. In contrast with the other inhabitants of German-occupied countries, Jews are not sent to work in the Reich, because Jewish immigration would run counter to the policy of making Germany ‘free of Jews’. The needs of the war economy are, of course, compelling the German authorities to deviate from this rule to some extent, and indeed some exceptions have been reported.^[813] But, generally speaking, deportation to the east is for the Jews the equivalent of the recruitment for work in the Reich to which the rest of the population of German-controlled Europe is subject, and their removal further and further eastward is doubtless connected with the need for supplying the army’s requirements near the front.”

The author reckons the number of the “deported and expelled and ... otherwise displaced” Jews to be 3,150,000, but makes this more precise:⁸¹⁴

“This does not include: (a) the hundreds of thousands of Polish Jews deported eastward from the General Government, and (b) hundreds of thousands of Jews transferred by compulsion within the limits of the same country or territory to be segregated in ghettos and special Jewish towns, in particular in the General Government and in the German-occupied Eastern Territories. Assuming that only a third of the resident Jews who remained in these territories were affected by (a) and (b), nearly 1,000,000 Jews must have been compulsorily removed eastward or from one town to another.”

Nowhere does Kulischer speak of ‘extermination camps’ or of a German policy of the physical extermination of the Jews!

⁸¹³ Kulischer gives as an example the deportation of 200 Jews from the Ukrainian Poltava to Vienna. *Ibid.*, p. 110, his note 1.

⁸¹⁴ *Ibid.*, p. 113.

Chapter IX: Transit Camp Treblinka

1. Deportations of Jews from the Warsaw Ghetto (1942)

The facts and circumstantial evidence assembled so far lead to the conclusion that Treblinka was mainly a transit camp established for the Jewish population of the Warsaw district, which fits within the framework of National Socialist policy of the resettlement of Jews to the east. The verifiable deportations to Treblinka can be explained in this sense. Let us begin with those from the Warsaw Ghetto.

According to the files of the Jewish Council of Warsaw, the following Jews were evacuated from the ghetto in the summer of 1942:⁸¹⁵

DATE	TRANSFERS	DULAG ⁸¹⁶	UNFIT	
			FOR WORK	TOTAL
7/22/1942	6,250	17	22	6,289
7/23/1942	7,300	490	25	7,815
5/24/1942	7,400	0	44	7,444
7/25/1942	7,350	130	50	7,530
7/26/1942	6,400	250	41	6,691
7/27/1942	6,320	130	74	6,524
7/28/1942	5,020	291	70	5,381
7/29/1942	5,480	225	17	5,722
7/30/1942	6,430	181	40	6,651
7/31/1942	6,756	98		6,854
8/1/1942	6,220	45		6,265
8/2/1942	6,276	49		6,325
8/3/1942	6,458	99		6,557
8/4/1942	6,568	140		6,708
8/5/1942	6,623	160		6,783
8/6/1942	10,085	1,369		11,454
8/7/1942	10,672	154		10,826
8/8/1942	7,304	351		7,655
8/9/1942	6,292	1,920		8,212
8/10/1942	2,158	1,531		3,689
8/11/1942	7,725	452		8,177

⁸¹⁵ "Likwidacja Żydowskiej Warszawy," *op. cit.* (note 125), pp. 81, 86, 90.

⁸¹⁶ Durchgangslager. Transit camp.

DATE	TRANSFERS	DULAG ⁸¹⁶	UNFIT FOR WORK	TOTAL
8/12/1942	4,688			4,688
8/13/1942	4,313			4,313
8/14/1942	5,168	331		5,499
8/15/1942	3,633	174		3,807
8/16/1942	4,095	408		4,503
8/17/1942	4,160			4,160
8/18/1942	3,976	220		4,196
8/19-24/42	20,000			20,000
8/25/1942	3,002			3,002
8/26/1942	3,000			3,000
8/27/1942	2,454			2,454
9/3/1942	4,609			4,609
9/4/1942	1,669			1,669
9/6/1942	3,634			3,634
9/7/1942	6,840			6,840
9/8/1942	13,596			13,596
9/9/1942	6,616			6,616
9/10/1942	5,199			5,199
9/11/1942	5,000			5,000
9/12/1942	4,806	2,100		6,906
Totals:	251,545	11,315	383	263,243

Thus, 251,545 Jews are supposed to have been deported to Treblinka and murdered there; another 11,315 Jews, however, are supposed to have been deported to the ghetto transit camp and put to work there. Are these figures reliable?

First, we emphasize the enormous discrepancy between the number of those fit and those unfit for labor: the former were supposed to have comprised 4.5%, the latter 95.5% of the deportees! Compared to this, on June 30, 1942, in the ghetto of Lodz, 68,896 Jews were employed, *i.e.* fit for work,⁸¹⁷ of a total population of 102,546 Jews,⁸¹⁸ therefore 67.2%!

Railway documents dealing with the deportation of Jews from Warsaw are unfortunately extremely rare. For the period of interest to us only a single schedule exists. It was issued on August 3, 1942, by the General Management of the Eastern Railway in Krakow, and reads:

“From August 6, 1942, until further notice, a special train with resettlers is running from Warsaw Danz BF [Danzig railway station] to Treblinka and running empty as follows [...]”

The departure of one train per day was scheduled: “1/. P Kr 9085 / 9.30 / Warsaw Danz Bf – Małkinia – Treblinka,” with departure at 12:25 PM, arrival at

⁸¹⁷ APL, PSZ, 174, p. 26.

⁸¹⁸ *Kronika getta łódzkiego*, Wydawnictwo łódzkie, Lodz 1965, Vol. 2, p. 100.

4:20 PM, and return “2/. Ln Kr 9086 / 11.30 / Treblinka – Małkinia – Warsaw Danz Bf” with departure at 7:00 PM and arrival at 11:19 PM.⁸¹⁹

Moreover, Albert Ganzenmüller, Secretary of State in the *Reichsverkehrsministerium* (Ministry of Transport) and Deputy General Director of the German *Reichsbahn* (National Railway), made the following report to *SS-Gruppenführer* Wolff on July 28, 1942:⁸²⁰

“Since July 22, a train with 5,000 Jews makes a daily trip from Warsaw to Treblinka via Małkinia, in addition to a train with 5,000 Jews traveling twice a week from Przemysl to Belzec.”

On August 13, Wolff responded:⁸²¹

“I have noted with especial pleasure your report that a train with 5,000 members of the Chosen People has already been running for 14 days to Treblinka every day, and we are thus indeed in a position to carry out this movement of population at an accelerated tempo.”

On April 11, 1962, Wolff was confronted with this letter during questioning as a witness at the preliminary investigations for the Frankfurt Auschwitz trial. Wolff made the following statement in reply to this:⁸²²

“At the time I did not connect the notion of a mass extermination camp with the name of Treblinka. I assumed it was a Jewish reservation [sic], as Himmler had explained it to me.”

Incredibly, not a single German report concerning such a large-scale displacement of population has been preserved. The only numerical information available to us comes from a terse excerpt from the Stroop Report:²⁴⁶

“The first large resettlement action took place in the period from 22 July to 3 October 1942. In this action 310,322 Jews were removed.”

This figure is definitely reliable and on the whole it corresponds to the table cited above, so that this may be taken to reflect actual numbers. It is also quite probable that most of the transports went to Treblinka. It is clear as well from the few train schedules extant that the trains were emptied at Treblinka and returned to their departure point without passengers. Of course, none of this proves that the deportees were murdered in Treblinka. The “Disclosures and Conditions for the Jewish Council” of July 22, 1943, prescribed:⁸²³

“All Jewish persons who live in Warsaw, of whatever age and sex, are to be resettled to the east.”

Exempted from the resettlement were, among others:

⁸¹⁹ Reproduced in Raul Hilberg, *op. cit.* (note 268), pp. 178f.

⁸²⁰ *Ibid.*, p. 177.

⁸²¹ *Ibid.*, p. 181.

⁸²² State Office of Prosecution at the Frankfurt (Main) District Court criminal proceedings against Baer and others at the Frankfurt Court of Assizes, Ref. 4 Js 444/59 Vol. 65, pp. 12, 100.

⁸²³ *Faschismus – Getto – Massenmord*, *op. cit.* (note 289), p. 305.

"[...] all Jewish persons who, on the first day of the evacuation, are in one of the Jewish hospitals and unable to be discharged. Whether a patient is able to be released is to be determined by a physician to be selected by the Jewish Council."

The following regulation pertains to the baggage:

"Each Jewish resettler is allowed to bring along 15 kg of his property as baggage for the trip. All valuables: gold, jewelry, money, etc., can be taken along. A food supply for 3 days should be brought along."

The announcement of the Jewish Council – likewise dated July 22, 1942 – contained the same instructions but began as follows:⁸²⁴

"By order of the German authorities all Jewish persons who live in Warsaw, of whatever age and sex, are to be resettled to the east."

The instructions in regard to baggage contained the following warning:⁸²⁵

"Baggage of more than 15 kg will be confiscated."

In an announcement of July 24, 1942, the Jewish Council proclaimed:⁸²⁶

"As a result of incorrect information, which is circulating in the Jewish quarter of Warsaw in connection with the evacuation, the Jewish Council in Warsaw was given permission by the authorities to announce that the evacuation of the populace not productively active in the Jewish quarter of Warsaw will, in fact, occur."

On July 29, 1942, the director of the Jewish *Ordnungsdienst* (constabulary) issued the following summons:⁸²⁷

"I am hereby announcing that all persons who will be resettled according to the instruction of the authorities will voluntarily report for the journey on the 29th, 30th, and 31st of July of this year, will receive 3 kg of bread and 1 kg of jam. Place of assembly for distribution of the products – Stawikiplac at the Wildstraße corner."

The German authorities were providing 180,000 kg of bread and 36,000 kg of jam for the volunteers.⁸²⁸

Let us summarize: The Jews of the Warsaw Ghetto were supposed "to be resettled to the east"; sick persons in the hospitals who were "unable to be discharged" were exempt from the evacuation; every person ready for resettlement received 3 kg of bread and 1 kg of jam – all of this does not conform to a policy of extermination.

It is worthwhile to quote what Eugene Kulischer wrote in this regard:⁸²⁹

"For the Polish ghettos are not the last stage in the forced eastward migration of the Jewish people. On 20 November 1941, the Governor Gen-

⁸²⁴ *Ibid.*, p. 110.

⁸²⁵ *Ibid.*, p. 111.

⁸²⁶ *Ibid.*, p. 115.

⁸²⁷ *Ibid.*, p. 309.

⁸²⁸ "Likwidacja żydowskiej Warszawy," *op. cit.* (note 125), p. 80.

⁸²⁹ E. Kulischer, *op. cit.* (note 799), pp. 110f.

eral, Hans Frank, broadcast the information that the Polish Jews would ultimately be transferred further east. Since the summer of 1942 the ghettos and labour camps in the German-occupied Eastern Territories have become the destination of deportees both from Poland and from western and central Europe; in particular, a new large-scale transfer from the Warsaw ghetto has been reported. Many of the deportees have been sent to the labour camps on the Russian front; others to work in the marshes of Pinsk, or to the ghettos of the Baltic countries, Bielorrussia and Ukraine.”

Kulischer was even aware that

*“on 22 July 1942, the Jewish Council of Warsaw received an order to prepare 6,000 persons to be sent away daily.”*⁸³⁰

In the months that followed, letters and post cards were addressed to their relatives by deported Jews arrived in the Warsaw Ghetto from Białystok, Pinsk, Bobruisk, Brzez, Smolensk, Brest Litovsk, and Minsk.⁸³¹ The resistance organizations in the ghetto, who at that time were already peddling the atrocity stories of the steam chambers, were of course making wild claims that these letters and cards were forgeries fabricated by the Germans to deceive the Jews. On December 4, 1942, this charge was made in an announcement of the Jewish resistance organization.⁸³² And an appeal of January 1943 by the Jewish resistance organization of the Warsaw Ghetto reported:⁸³³

“In the course of the last weeks, people of certain circles have been spreading news about letters, which supposedly came from Jews who were evacuated from Warsaw and who are now supposed to be in labor camps at Pinsk or Bobruisk.”

The authors of the appeal were alleging that such news was being spread by people “who are working for the Gestapo.” The official historiography later abandoned this simple-minded assertion and has supported the thesis that the letters and post cards had been “written under duress at Treblinka,”⁸³⁴ but not a single one of the self-described survivors of Treblinka has made claims of this kind. In fact, this information confirms – however fragmentarily – the picture drawn by E. Kulischer.

On May 30, 1943, a transport was sent to Bobruisk with 960 Jews who had been arrested in the Warsaw Ghetto. On July 28 of the same year, another transport of Jews from Warsaw arrived in Bobruisk; a portion of the deportees were sent on to Smolensk.⁸³⁵

⁸³⁰ *Ibid.*, p. 110, his note 2.

⁸³¹ Mark Weber and Andrew Allen referred to this fact in their article “Treblinka,” *op. cit.* (note 110), pp. 139f.

⁸³² Lucy Dawidowicz, *The Holocaust Reader*, Berman House, New York 1976, p. 356.

⁸³³ *Faschismus – Getto – Massenmord*, *op. cit.* (note 289), p. 496.

⁸³⁴ Lucy Dawidowicz, *The War against the Jews 1933-1945*, Bantam, New York 1976, p. 414.

⁸³⁵ C. Gerlach, *op. cit.* (note 418), p. 762.

In the *Informacja Bieżąca* No. 30 of August 17, 1942, is a reference to 2,000 “skilled workers” on a transport of August 1 from the Warsaw Ghetto to Smolensk. Another transport with 2,000 craftsmen departed for Malaszewicz,⁸³⁶ a town at the border to White Russia, about 12 km from Brest. The report of September 7, 1942, “Liquidation of the Warsaw Ghetto” mentioned earlier confirmed.⁸³⁷

“Two small transports with 4,000 persons were sent for labor at installations important for the war in Brzesc and Malachowicze.”

Finally, the arrival of at least one transport from the Warsaw Ghetto at a location east of Treblinka has been documented beyond any question. On 31 July 1942, the *Reichskommissar* for White Russia, Wilhelm Kube, sent a telegram to the *Reichskommissar* for the Ostland, Hinrich Lohse, in which he protested the dispatching of a transport of “1,000 Jews from Warsaw to work at Minsk,” because this would lead to danger of epidemics and an increase in partisan activity.⁸³⁸

On August 5, 1942, Lohse responded in a letter with the subject “Import of 1,000 Jews from Warsaw,” in which he indicated that

“the practical realization of the solution of the Jewish problem is exclusively a matter for the police.”

The responsibility “for the orderly realization of the measures,” was also that of the police, so that protests were not permissible.⁸³⁹

Kube raised the problem anew in a letter written on August 17, 1942, to Lohse (under the same rubric, “Import of 1,000 Jews from Warsaw”) and requested further instructions, since he wished to make “fundamental decisions concerning the acceptance of further Jews into White Russia as a police matter.”⁸⁴⁰

At least one Jewish transport “with workers” (P KR 9130) arrived in Treblinka on August 25, 1942, from Międzyrzec Podlanski,⁸⁴¹ but there is no reference that it was for the labor camp Treblinka I.

Deportations of Jews from the Warsaw Ghetto to ghettos of the Baltic countries Latvia and Lithuania find additional confirmation in the deportation lists of Jewish transports, already mentioned, from Kaunas and Riga to Stutthof in the summer of 1944. These lists, although only fragmentarily preserved, include the names of approximately 1,200 Polish Jews, among them 112 boys and girls of up to 15 years of age.

⁸³⁶ K. Marczevska, W. Waźniewski, *op. cit.* (note 51), p. 137.

⁸³⁷ HI, Report on conditions in Poland. Annex No. 7, HI, Box 29.

⁸³⁸ GARF, 7445-2-145, p. 80. Cf. Document 22 in the Appendix.

⁸³⁹ GARF, 7445-2-145, p. 81. Cf. Document 23 in the Appendix.

⁸⁴⁰ GARF, 7445-2-145, p. 85.

⁸⁴¹ Railway schedule no. 562 of August 22, 1942. Reproduction in R. Hilberg, *op. cit.* (note 268), p. 183.

Furthermore, sources already cited earlier mention the transfer of Jews from Polish ghettos to the Ukraine by way of Belżec at the end of March 1942. G. Reitlinger writes regarding this:⁸⁴²

“The reports, which reached the Polish Exile Government in London, that Jews were resettled in Russia from Belzec camp, should be discounted as part of the camouflage that Heydrich had been creating since the Wannsee conference. In fact, the allusions to the Krivoi Rog Jewish colonies and the Pinsk land reclamation camps may derive from fake field postcards.”

Therefore, while the *Einsatzgruppen* were allegedly shooting Jews in the broad light of day with no attempt at secrecy, other SS personnel were taking pains to forge postcards in order to cover up their alleged mass murders in ‘extermination camps’!

2. Warsaw Ghetto Uprising and the Stroop Report

In his well-known report of May 16, 1943, on the destruction of the Warsaw Ghetto, SS-Brigadeführer Jürgen Stroop emphasized:⁸⁴³

“When the Reichsführer SS visited Warsaw in January 1943 he ordered the SS and Police Leader for the District of Warsaw to transfer to Lublin the armament factories and other enterprises of military importance which were installed within the Ghetto including their personnel and machines.”

According to Yitzhak Arad, 6,000 Jews were deported from the Warsaw Ghetto to Treblinka between the 18th and the 22nd of January 1943.⁸⁴⁴ In fact, on January 9, 1943, Himmler had ordered SS *Obergruppenführer* Krüger to transfer 8,000 Jews from the Warsaw Ghetto into the camps in the area around Lublin and to deport another 15,000 by the 15th of February.⁸⁴⁵ On February 2, 1943, SS *Oberführer* Ferdinand von Sammern, SS and Police Chief in the Warsaw district, sent a secret letter to Himmler, in which he wrote regarding the firms in the Warsaw Ghetto:⁸⁴⁶

“Not only the firm of Többen and Schulz & Co., but also all the rest, 8 firms altogether with approximately 20,000 Jewish workers, are being re-located into the concentration camp at Lublin.”

According to the Stroop Report, the number of deported Jews amounted to 6,500.⁸⁴³

⁸⁴² G. Reitlinger, *op. cit.* (note 180), p. 270.

⁸⁴³ PS-1061. IMT, Vol. XXXVI, p. 635.

⁸⁴⁴ Y. Arad, *op. cit.* (note 71), p. 392.

⁸⁴⁵ *Faschismus – Getto – Massenmord*, *op. cit.* (note 289), p. 349.

⁸⁴⁶ *Ibid.*, pp. 449f.

On March 31, 1943, Dr. Max Horn, together with Odilo Globocnik, the director of the firm Ostindustrie GmbH (Osti), informed the Director of the Central Construction Office of Lublin-Majdanek.⁸⁴⁷

“Due to the order of the Reichsführer SS, for police reasons and in the interests of increasing the Jewish labor assignment, the important armament firms located in the Warsaw Ghetto that have a Jewish work force must be moved as quickly as possible. The move will be to Poniatowa, Trawniki, and Lublin into buildings that are already there.”

The Jews resisted voluntary evacuation, and on April 19, Stroop advanced into the ghetto with his troops, after which the armed struggle began.

The Stroop Report is cited by official historiography as proof that Treblinka was an extermination camp. For example, G. Reitlinger claims that “7,000 Jews had officially been killed in the ghetto and 7,000 ‘taken to T 2.’”⁸⁴⁸ R. Hilberg picks up this number:⁸⁴⁹

“Several thousand Jews had been buried in the debris, and 56,065 had surrendered. Seven thousand of the captured Jews were shot; another 7,000 were transported to the death camp at Treblinka, 15,000 were shipped to the concentration camp and killing center at Lublin, and the remainder were sent to labor camps.”

Neither Reitlinger nor Hilberg gives the sources for these figures. This turns out to be a teletype of May 24, 1943, in which Stroop reported:⁸⁵⁰

“Of the total of 56,065 Jews registered, approximately 7,000 were wiped out as a result of the major action in the former Jewish quarter itself. By transport to T. II, 6,929 Jews were destroyed, so that in all 13,929 Jews were annihilated. Beyond the figure of 56,065, an estimated 5-6,000 Jews were destroyed by explosions and by fire.”

This teletype is not contained in the Stroop Report, which bears the title “There Is No Longer a Jewish Residential District in Warsaw!” and was presented as document PS-1061 during the Nuremberg Trial.⁸⁵¹ The Stroop Report actually ends with a teletype of May 16, 1943. L. Poliakov and J. Wulf say in a footnote:⁸⁵²

“Document PS-1061 also contains a copy of the Stroop Report with a report of the day from May 24, 1943 (see facsimile), which is missing from the original report.”

⁸⁴⁷ WAPL, ZBL, 268, p. 1.

⁸⁴⁸ G. Reitlinger, *op. cit.* (note 180), p. 298.

⁸⁴⁹ R. Hilberg, *op. cit.* (note 17), Vol. 2, pp. 512.

⁸⁵⁰ Teletype of Stroop of May 24, 1943. Reproduction in: L. Poliakov, J. Wulf, *op. cit.* (note 379), pp. 168f.

⁸⁵¹ IMT, Vol. XXVI, pp. 628-694.

⁸⁵² L. Poliakov, J. Wulf, *op. cit.* (note 379), p. 159.

The passage involved was cited at the Nuremberg Trial at the proceedings of December 14, 1945.⁸⁵³

Stroop gave three different versions of the fate of the 56,065 registered Jews. We are already familiar with the one contained in the teletype of May 24 and taken up by R. Hilberg. In the teletype of May 16 he reported:⁸⁵⁴

“The total number of Jews registered and proven killed amounts to a total of 56,065” (Emphasis added)

Yet it is obviously false that 56,065 Jews were “proven killed”!

In a statement of February 24, 1946, made under oath, Stroop finally gave the following testimony:⁸⁵⁵

“After the people were taken out of the ghetto, 50 to 60,000 in number, they were taken to the railroad station. The security police had absolute control over these people and had the transportation to Lublin under their [authority].”

According to this, the 56,065 registered Jews were deported to Lublin.

The Stroop Report raises still other problems. Its author presents statistics, in which two categories of Jews are named: those killed and those ‘registered,’ but those killed also belong to the latter. Stroop gives the total number of the Jews who were “already evacuated or registered for relocation” from the 23rd of April on: 19,450.⁸⁵⁶

In the following table we reproduce the figures of the Stroop Report. We have separated the number of those killed from that of those ‘registered’ when they are given together,⁸⁵⁷ so that the respective column lists only the Jews held alive. One arrives at the total number by adding to the total of the previous day the figures of the day after, for example (for the 24th and 25th of April) 25,500 + 1,964 + 27,464. The single exception is the numbers for the 23rd and 24th of April, since 19,450 + 1,990 = 21,440 and not 25,500, so that (25,500 – 21,440 =) 4,060 persons are missing. In the report of April 24, Stroop mentions also 1,814 Jews who were “pulled out of bunkers” and who had to be added to the “1,660 Jews [who] were seized for relocation,” so that the total number missing is (4,060 – 1,814 =) 2,246. These Jews presumably belong to the 3,500 ‘registered’ on the previous day, as in the report for May 6, in which the 2,850 Jews “registered for the relocation” were included in the total number of the day before,⁸⁵⁸ although Stroop reports a figure of 1,070 as the total number for the day.

⁸⁵³ IMT, Vol. III, p. 557.

⁸⁵⁴ PS-1061. IMT, Vol. XXVI, p. 693.

⁸⁵⁵ PS-3841. IMT, Vol. XXXIII, p. 202.

⁸⁵⁶ *Ibid.*, p. 653.

⁸⁵⁷ For example, it says in the report of April 27: “2,560 Jews caught, 547 of them shot.” Our calculation therefore looks like this: (2560–547=) 2013 taken alive as prisoners.

⁸⁵⁸ Obviously these Jews had been taken prisoner on the day before.

PAGE ⁸⁵⁹	DATE	KILLED	REGIST.	TOTAL FOR	
				THE DAY	TOTAL
650	22 Apr. 1943	230 ⁸⁶⁰	1,100	1,330	⁸⁶¹
652	23 Apr. 1943	800	2,700	3,500	19,450
655	24 Apr. 1943	330	1,660	1,990	25,500
656	25 Apr. 1943	274	1,690	1,964	27,464
659	26 Apr. 1943	1,692	30	1,722	29,186
661	27 Apr. 1943	547	2,013	2,560	31,746
664	28 Apr. 1943	110	1,545	1,655	33,401
665	29 Apr. 1943	106	2,253	2,359	35,760
667	30 Apr. 1943	179	1,420	1,599	37,359
668	1 May 1943	245	781	1,026	38,385
670	2 May 1943	235	1,617	1,852	40,237
672	3 May 1943	95	1,474	1,569	41,806
674	4 May 1943	204	2,079	2,283	44,089
676	5 May 1943	126	944	1,070	45,159
677	6 May 1943	356	1,553	1,909	47,068
679	7 May 1943	255	1,019	1,274	48,342
680	8 May 1943	280	1,091	1,371	49,713 ⁸⁶²
682	9 May 1943	573	1,037	1,610	51,313
683	10 May 1943	187	1,183	1,370	52,683
685	11 May 1943	51	931	982	53,667
686	12 May 1943	133	663	796	54,463
687f.	13 May 1943	155	561	716	55,179
691	14 May 1943	154	398	552	55,731
692	15 May 1943	67	87	154	55,885
693	16 May 1943	180	0	180	56,065
Totals:		7,564	29,829		

The total number of Jews killed is 7,564. Insofar as Treblinka is concerned, this camp is abbreviated to "T II" four times in the Stroop Report. The first time it is mentioned is in the teletype of April 25. The relevant text, which we reproduce below, is often cited in the official literature as proof that Treblinka is supposed to have been an extermination camp:⁸⁶³

"Today's action came to an end for almost every shock troop, in that huge fires broke out and thereby caused the Jews to leave their hiding places and bolt holes. There were 1,690 Jews captured alive. According to the tales the Jews relate, among them there are certainly some who were para-

⁸⁵⁹ IMT, Vol. XXVI, on the page cited.

⁸⁶⁰ The text reads 203, but in another report, which refers to the same day (p. 647), the figures given are for 150 shot, 80 killed in a bunker explosion, so that a total of 230 Jews were killed.

⁸⁶¹ The total number for April 22 and the previous day is not given.

⁸⁶² The erroneous figure of 49,712 appears in the text.

⁸⁶³ PS-1061. IMT, Vol. XXVI, p. 656.

chuted in and bandits who were supplied with weapons from an unknown location. 274 Jews were shot and, as on every day, countless Jews buried alive and burned in blown-up bunkers, as can be discovered time after time. With the Jews who have been bagged today, in my opinion a very large part of the bandits and lowest elements of the ghetto have been captured. Due to the onset of darkness, their immediate liquidation was no longer carried out. I will try to get a train to T II for tomorrow, otherwise the liquidation will be carried out tomorrow.”

One day after this, Stroop noted in his teletype:⁸⁶⁴

“At present there are no more of the registered Jews in Warsaw. The prescribed transport to T II took place.”

The next mention of Treblinka occurs in the teletype of May 12:⁸⁶⁵

“The transports of Jews now leaving from here are being taken to T II for the first time today.”

Finally, the teletype of May 13 reads:⁸⁶⁶

“Today 327 Jews were captured in a Wehrmacht operation. The Jews now captured are taken only to T II.”

The Stroop Report gives rise to three questions in this connection:

1. How many Jews were deported to ‘T II’?
2. Were the Jews deported to Treblinka gassed?
3. Where did the majority of the Jews from the ghetto go?

We will now address the first of these questions. On April 25, 1943, a total of 1,990 Jews were taken prisoner, of whom 274 were shot. The shooting operation was interrupted by the onset of twilight. The transport to Treblinka thus could include only the remaining (1,990 – 274 =) 1,716 persons. But this is the largest number deported to Treblinka in a single day. This is confirmed by the fact that on the next day, 1,722 Jews were taken prisoner, of whom 1,692 were killed; the total number for the 26th of April corresponds to that of April 25 plus those 1,722 Jews: 27,460 + 1,722 = 29,182.

The report of May 12 states that the Jewish transports leaving from Warsaw were sent to “T II for the first time” on that day. It is not clear how this jibes with the transport of April 25, the first to Treblinka. In any case, it is clear from the May 13 teletype that only the Jews who were taken prisoner were sent to Treblinka.

According to the above table, on May 12, 1,709 Jews were taken prisoner.

The maximum number of Jews deported to Treblinka during this period therefore amounts to (1,660 + 1,709 =) 3,369. Thus it is not clear how Stroop arrived at a figure of 6,929 in his teletype of May 24. More important, though, is another problem: if these Jews were destroyed in ‘T II,’ does this mean that

⁸⁶⁴ *Ibid.*, p. 660.

⁸⁶⁵ *Ibid.*, p. 686.

⁸⁶⁶ *Ibid.*, p. 688.

Treblinka was a camp established for the purpose of killing people? In our view, the ‘liquidation’ there of a few thousand Jews, whom the SS classified as “bandits and lowest elements of the ghetto,” proves neither that they were gassed, nor that Treblinka was operated as an ‘extermination camp.’ If one bears in mind that the camp was only 80 km from Warsaw, then it would not be surprising if the SS had shot a few thousand people there whom they were unable or unwilling to execute in the city. But another problem arises. In the introduction to his report Stroop writes:⁸⁶⁷

“During the major operation, Jews were captured who already had been shifted to Lublin or Treblinka, broke out of there and returned to the ghetto supplied with weapons and munitions.”

There is thus reason to doubt that the (according to Stroop) 6,929 Jews deported to Treblinka were all ‘annihilated.’ One of these Jews, a Samuel Zylbersztajn, was in fact deported to Majdanek on April 30, 1943, from the alleged extermination camp Treblinka as a member of a transport of 308 Jews.⁸⁶⁸ The title of his memoir translates as “The Memoirs of an Inmate of Ten Camps.” After the ‘extermination camp’ Treblinka, Zylbersztajn survived the ‘extermination camp’ Majdanek and eight ‘ordinary’ concentration camps; he is thus living proof of the fact that the Germans did not systematically exterminate their Jewish prisoners.

Another 356 Jews were transferred from Treblinka to Majdanek on May 13, 1943.⁸⁶⁹ The Jewish historians Tatiana Berenstein and Adam Rutkowski write:⁸⁷⁰

“Some of the transports from Warsaw reached Lublin by way of Treblinka, where the selection of the deportees took place.”

This fact is confirmed by some witnesses who were interrogated during the extradition proceedings against John Demjanjuk. In the official compilation of the interrogations,⁸⁷¹ which we have in our possession, the names of the witnesses have been rendered unreadable, so that we refer to the interrogations by the dates, on which they occurred.

Interrogation of December 12, 1979: The witness was deported in April 1943 from Warsaw to Treblinka. On the next day he was transferred to Maj-

⁸⁶⁷ *Ibid.*, p. 638.

⁸⁶⁸ Samuel Zylbersztajn, “Pamiętnik więźnia dziesięciu obozów,” in: *Biuletyn Żydowskiego Instytutu Historycznego w Polsce*, No. 68, 1968, pp. 53-56. The author expressly cites April 30, 1943, as the date of his deportation to Treblinka.

⁸⁶⁹ T. Mencil (ed.), *Majdanek 1941-1944*, Wydawnictwo Lubelskie, Lublin 1991, p. 448.

⁸⁷⁰ Tatiana Berenstein, Adam Rutkowski, “Żydzi w obozie koncentracyjnym Majdanek (1941-1944),” *Biuletyn Żydowskiego Instytutu Historycznego w Polsce*, No. 58, 1966, p. 16.

⁸⁷¹ *U.S. Department of Justice. Criminal Division. Office of Investigation. Report of Investigation. Subject “Demjanjuk Ivan, Fedorenko Feodor.”* These protocols were enclosed with the documents in the Jerusalem Demjanjuk Trial (State of Israel vs. Ivan [John] Demjanjuk. Criminal Case No. 373/86 in the Jerusalem District Court; cf. Chapter V). Our thanks to Dr. Miroslav Dragan, who made these documents available to us.

danek, where he spent 6-7 days; afterward he went to Budzyn for approximately a year. From Budzyn he was sent to Wieliczka (in the vicinity of Krakow), from there to Flossenbürg in mid-1944, and finally to Leitmeritz.

Interrogation of December 17, 1979: the witness was deported from Krakow to Płaszów, and from there to Auschwitz. After that he went to Oranienburg and finally to Flossenbürg. He stated that he spent a single day in Treblinka without giving details.

Interrogation of January 3, 1980: the witness was taken prisoner in May 1943 in Warsaw and sent directly to Majdanek, from where he was later transferred to Budzyn.

Interrogation of March 7, 1980: The witness was deported in April 1943 from Warsaw to Treblinka, where he stayed for only one day; then he was transferred along with 180 other prisoners to Majdanek. After two days his trip continued to Budzyn, where he spent two years. He was liberated by the Soviets from an unnamed German concentration camp.

Interrogation of March 11, 1980: the witness was sent to Treblinka in April 1943, where he spent only a day. Transfer to Majdanek, thence to Budzyn, where he was interned for about a year. Liberated on May 5, 1945, from Mauthausen.

Interrogation of July 18, 1980: the witness was deported on April 18, 1943, from Warsaw to Majdanek. After 5 weeks he went to Auschwitz and then – toward the end of 1944 – to Gusen (a subcamp of Mauthausen) where he was liberated.

The verdict of the Court of Assizes of Düsseldorf determined, plainly and clearly, on September 3, 1965, that

*“several thousand people from Treblinka are said to have arrived at other camps.”*⁸⁷²

To conclude, we turn to the question of the location/s to which the majority of the deportees were sent. According to T. Berenstein and A. Rutkowski, 30,000 to 40,000 Jews were deported from the Warsaw Ghetto to Lublin, where several transports arrived by way of Treblinka, where a selection of those able to work had already been conducted.⁸⁷³ The Polish historian Zofia Leszczyńska writes that the Jews from Warsaw were distributed as follows: 14,000 to Poniatowo, 6,000 to Trawniki, 800 to Budzyn, and 16,000 to Majdanek.⁸⁷⁴ According to her chronology of the transports, which contains large gaps, the following transports of Jews arrived in the Lublin-Majdanek Camp from Warsaw:

⁸⁷² A. Rückerl, *NS-Vernichtungslager...*, *op. cit.* (note 61), p. 198.

⁸⁷³ T. Berenstein, A. Rutkowski, *op. cit.* (note 870), p. 16.

⁸⁷⁴ Zofia Leszczyńska, “Transporty więźniów do obozu w Majdanku,” in: *Zeszyty Majdanka*, IV, 1969, p. 194.

- April 27: 3,496 persons including children
- April 28: number unknown, including children
- April 30: number unknown, including children
- May 1: number unknown, including children
- May 2: number unknown, including children
- May 3: number unknown, including children
- May 8: 861 men
- May 9: 895 men
- May 10: 875 men
- May 14: number unknown, including children.⁸⁷⁵

3. Deportations from the Ghetto of Białystok and the Transit Camp Małkinia

The clearing out of the ghetto of Białystok was planned for August 16, 1943. The Jews in the ghetto put up a weak resistance, and from the 16th to the 20th of August there were clashes until the inhabitants were subdued by the Germans. As to the fate of the Jews taken prisoner, the *Encyclopedia of the Holocaust* reports:⁸⁷⁶

“The deportations from the ghetto began on August 18 and went on for three days, in the course of which the greater part of Białystok’s Jews were deported. Some were sent to Treblinka, where they were murdered, and others to MAJDANEK, where they went through a Selektion. Those who were found fit were taken to the PONIATOWA camp, the Bliżyn camp, or to AUSCHWITZ. A train with 1,200 Białystok children aboard was sent to THERESIENSTADT; a month later, these children too ended up in Auschwitz.”

The author of this article,⁸⁷⁷ however, does not cite the important arguments already put forth by Gerald Reitlinger. The latter writes:⁸⁷⁸

“A chance survival of way-bills in the Königsberg office of the German State Railways reveals the fact that five special trains left Białystok for Treblinka between August 21st and 27th, 1943. 266 wagons were sent. On such a journey, occupying normally two-and-a-half hours, a box-car would hold from eighty to a hundred Jews. Thus there was room for all 25,000 survivors.”

According to Reitlinger, these 25,000 Jews were all ‘gassed.’ The source cited by him is the English translation of an article written by Z. Łukaszkiwicz,

⁸⁷⁵ T. Mencil, *Majdanek 1941-1944, op. cit.* (note 869), pp. 447f.

⁸⁷⁶ *Encyclopedia of the Holocaust, op. cit.* (note 18), Vol. I, pp. 213.

⁸⁷⁷ See the entry “Białystok” in the *Encyclopedia of the Holocaust, ibid.*

⁸⁷⁸ G. Reitlinger, *op. cit.* (note 180), p. 306.

which we cited in Chapter III.⁸⁷⁹ There, a “*wykaz wagonów*” (railway carriage label), a telegram of August 18, as well as “railway schedule no. 290”⁸⁸⁰ from the railway administration of Königsberg are mentioned, in which we find the order:

“The following special trains for the transport of resettlers are running from Białystok to Malkinia, destination Treblinka.”

As we have already seen, the schedule in the documents cited by Łukaszkiwicz looks like this:

17 August:	⁸⁸¹ 39 cars
18 August:	39 cars
19 August:	35 cars
21 August:	38 cars
21 August:	38 cars
22 August:	38 cars
22 August:	38 cars
23 August:	38 cars
In all: 8 trains and 303 cars.	

It is nonetheless certain that the Jews from the ghetto of Białystok were for the most part deported to the area of Lublin. According to T. Berenstein and A. Rutkowski, 24,000 of these Jews were brought to Majdanek.⁸⁸²

On August 20, 1943, a transport with 2,031 persons arrived in Majdanek from Białystok.⁸⁸³ It contained men, women, and children,⁸⁸⁴ so that no kind of selection could have taken place in Treblinka. On the same day, at least one other transport arrived in Majdanek with approximately 2,000 Jews (men, women, and children).⁸⁸⁵ Also, the transport with 1,200 children (originally intended for Palestine⁸⁸⁶) between 6 and 12 years of age, which arrived in Theresienstadt on August 24,⁸⁸⁷ traveled by way of Treblinka, which therefore served as a transit camp for these transports.

⁸⁷⁹ “The Treblinka extermination camp,” in: Central Commission for Investigation of German Crimes in Poland (ed.), *German Crimes in Poland*, Warsaw 1946, pp. 103f.

⁸⁸⁰ Cited in German in the text: “Fahrplananordnung Nr. 290”.

⁸⁸¹ The text erroneously has August 27. The date of August 17 appears in the German translation of the article concerned (USSR-344).

⁸⁸² T. Berenstein, A. Rutkowski, *op. cit.* (note 870), p. 450.

⁸⁸³ GARF, 7021-107-3, p. 258. See Document 24 in the Appendix.

⁸⁸⁴ Z. Leszczyńska, *op. cit.* (note 874), p. 227.

⁸⁸⁵ T. Mencil, *Majdanek 1941-1944, op. cit.* (note 869), p. 450.

⁸⁸⁶ Brona Klibanski, “Kinder aus dem Ghetto Białystok in Teresienstadt”, in: *Theresienstädter Studien und Dokumente*, 1995, p. 93.

⁸⁸⁷ *Tereziská pametní kniha, op. cit.* (note 569), p. 70. There a figure of 1220 Jews who arrived in Theresienstadt from Białystok is given. Obviously 20 adults who accompanied the children are included in this.

According to Danuta Czech, on December 10, 1942, a transport with 2,500 persons, from which 524 men were registered with the numbers 81,400 to 81,923, arrived in Auschwitz from the transit camp Małkinia. The remaining 1,976 are supposed to have been gassed. On December 12 of the same year, again according to Danuta Czech, a transport from the transit camp Małkinia also arrived in Auschwitz with 2,000 Polish Jews, of whom 416 men, assigned the numbers 82,047 to 82,462, and six women, assigned the numbers 26,800 to 26,805, became part of the regular camp population; this time, too, Danuta Czech claims that the rest were gassed.⁸⁸⁸

If one consults the *Informator encyklopedyczny* of the ‘Main Commission for the Investigation of the Hitler Crimes in Poland,’ in which all camps and prisons on Polish soil during the German occupation are listed, one finds no camp of either kind under the heading of Małkinia.⁸⁸⁹ But on the air photo of May 15, one clearly recognizes a camp there, along the road to Ostroleka, which quite remarkably runs through this camp and about 5 km from Treblinka. Its function is not known.⁸⁹⁰

In the first German edition of her “Kalendarium,” D. Czech had written that the two transports arrived from the ghetto of Ciechanów.⁸⁹¹

These two transports are to be seen in the context of the Jewish transports from Kielbasin (called Lososna by the Germans), which took place between November 9 and December 20, 1942. This is a site about 50 km northeast of Białystok on the road to Grodno. During the course of this operation, further transports are supposed to have been directed to Treblinka: one with 7,000 Jews on December 14, the last on the 20th of the same month.⁸⁹²

Since the alleged ‘extermination camp’ Treblinka is supposed to have been in operation at that time, it makes no sense that these more than 3,500 Jews unfit for labor are supposed to have been dispatched for ‘gassing’ to the more than 500 km distant Auschwitz rather than to nearby Treblinka. But if there were transports to Treblinka in addition to those, the conclusion is almost inescapable that those sent to Auschwitz also arrived there by way of Treblinka, as did those from the Białystok ghetto.

⁸⁸⁸ D. Czech, *op. cit.* (note 409), p. 283, 284.

⁸⁸⁹ *Obozy hitlerowskie...*, *op. cit.* (note 64), p. 314. Malomice comes after Malki there.

⁸⁹⁰ John C. Ball, *Air Photo Evidence*, *op. cit.* (note 101), p. 79 and 88; pp. 122, 132 in Rudolf’s 2020 edition.

⁸⁹¹ D. Czech, “Kalendarium der Ereignisse im Konzentrationslager Auschwitz- Birkenau”, Issue 3, Wydawnictwo Państwowego Muzeum w Oświęcimiu, 1960, pp. 106f.

⁸⁹² C. Gerlach, *op. cit.* (note 418), p. 727.

4. Treblinka: Gas Chambers or Delousing Chambers?

If one assumes that Treblinka was a transit camp, then one can also interpret the description of the witnesses' alleged extermination facilities. In his 1995 article, mentioned in the first chapter, J.-C. Pressac advanced a very interesting hypothesis with regard to the supposed extermination camps. He wrote:⁸⁹³

“Only one Polish witness, Stanisław Kosak,^[894] has described the construction of the extermination camp Belzec from November 1941. There were three barracks built next to one another: the first served as a waiting room for the Jews, in the second they bathed and in the third they were gassed in three rooms. Railway cars making a circuit on a narrow-gauge track took care of transporting the bodies to a pit located at the edge of the camp. Kosak adds that three ovens connected with the water supply system were installed in the gas chambers.

In this homicidal installation two elements do not make sense: the baths (why should the deportees have been allowed to bathe before their gassing?) and the three ovens connected to water pipes (carbon monoxide of course was used for the killing).

For Treblinka, the witnesses described in different words exactly the same sequence: entry into the undressing room, then into the bath, after that into a room for testing asphyxiation gases, which was next to a furnace room, from whence the tracks led to a ‘cemetery.’ They mention the use of steam in the gas chambers. This ‘death-house’ has more bizarre aspects than that of Belzec: bath, steam, and ovens, whose purpose cannot have been that of incinerating the bodies, since these of course were buried in the ‘cemetery.’ A report of November 1942, which was sent to London, confirms that the suffocation chambers consisted of three rooms 4 × 4 m in dimension with a heating room, where there was a boiler for the production of steam, which was then conducted into the three chambers. These contradictions prove that the statements of the witnesses have not been ‘arranged,’ but rather correctly represent the words of the witnesses.

Instead of starting with the assumption of a facility for killing people, the hypothesis must be accepted that from the end of 1941 until mid-1942, three delousing facilities were established in Belzec, Sobibór, and Treblinka. The fact that places were chosen for this at a border, which had become obsolete, can be explained if one recalls the concepts of prophylactic hygiene and the battle against typhus by means of killing the insects carrying it, the lice, and if one considers that the Germans had typhus more or less under control in their zone of occupation, but not in the conquered Soviet territories. Thus, the program for the deportation of the Jews to the

⁸⁹³ J.-C. Pressac, “Enquête...,” *op. cit.* (note 88), pp. 120f.

⁸⁹⁴ Correct: Kozak.

east, as decided upon at the Wannsee Conference of January 20, 1942, was adhered to by processing the deportees through these three hygiene facilities. That Belzec was established prior to the Wannsee Conference can be explained by the postponement of this conference or also by the possibility that the witness Kosak has given a false date for the establishment of the delousing facility.”

A whole array of arguments points to the fact that Pressac has hit the nail on the head. In the second chapter we saw that according to the testimony of the witnesses the alleged extermination installations of Treblinka were camouflaged as a ‘bath.’ This point merits a closer analysis.

Rachel Auerbach mentions “a whole list of instructions about bathing and disinfection, about what to do with money, jewels and documents.” In some cases the new arrivals were actually handed receipts after they had deposited their valuables at the check-in counter.⁸⁹⁵ She writes that the women were often asked to take towels with them into the bathhouse,⁸⁹⁶ and explains:⁸⁹⁷

“[...] this door led to the ‘bathing establishment.’ This was a gray-white building with all the accoutrements of a regular public bath in the inside: ‘cabins,’ plus a few chimneys protruding from the roof. [...] The floor sloped down to wide, hermetically sealed chutes facing the entrance gate. Real shower heads were set in the ceilings of the rooms, but they were not connected to any water pipe.”

Later she says:⁸⁹⁸

“[...] in the early days the Jews were told as they undressed and turned in their money to keep 1 zloty in order to pay ‘for the bath.’ A Ukrainian guard would sit in a wooden hut at the entrance to the ‘Road to Heaven’ and collect the zlotys.”

The report of November 15, 1942, adds one further important piece of circumstantial evidence: the boiler room for the production of steam, which makes total sense in a disinfection and delousing facility, but which in an installation for extermination has no function whatsoever. Steam was in fact one of the methods at that time for disinfecting and delousing.⁸⁹⁹ The Silberschein Report completes the picture of the evidence: directly after their arrival, the deportees were informed they would be continuing their journey “to work in the east.” According to the verdict of the Düsseldorf Court of Assizes of 1965, the Warsaw Jews were greeted with the following address:⁹⁰⁰

⁸⁹⁵ A. Donat, *op. cit.* (note 4), p. 30.

⁸⁹⁶ *Ibid.*, p. 31.

⁸⁹⁷ *Ibid.*, p. 34.

⁸⁹⁸ *Ibid.*, p. 54.

⁸⁹⁹ Walter Dötzer, *Entkeimung, Entwesung*. Operational instructions for the clinic and laboratory of the Institute of Hygiene of the Waffen-SS, Berlin, Urban and Schwarzenberg Publishers, Berlin and Vienna 1943, pp. 16-21 and 87f.

⁹⁰⁰ A. Rückerl, *NS-Vernichtungslager...*, *op. cit.* (note 61), p. 219.

“Attention Warsaw Jews!

You are in transit camp here, from which further transport to a labor camp will occur.

For the prevention of epidemics, clothing as well as articles of baggage are to be handed over for disinfection. Gold, money, foreign currency, and jewelry are to be surrendered in exchange for a receipt at the counter. They will be returned later, upon presentation of the receipt.

All those arriving have to bathe for bodily cleanliness before traveling on.”

According to the November 15, 1942, report, after this speech the deportees were subdivided according to their occupations. In fact, the SS had established a bureau at the camp train station “where every new arrival had to go and report his professional training.”

The report continues:

“the people were taken into the camp and at first only sent into the baths for disinfection. After the bath they were temporarily sent into the single cells. There they were supposed to wait until it was their turn.”

The sketch enclosed with the Silberschein Report⁹⁰¹ shows a men’s camp, a children’s camp, and a women’s camp; the deportees would have gone there following their bath. The *Informacja bieżąca* of August 17, 1942, claimed that in Treblinka “the camp was at a strength of 40,000 Jews on August 5,”⁹⁰² which indicates internment of the deportees after the bath.

The report then states that the Jews were sent “into the gas- and oven-chambers” and killed there – but why on earth were they ordered to bathe beforehand? The alleged extermination facility, as it is represented in the sketch, is revealing in other ways: the building consisted of a dressing room, a bathing room, a “room for testing asphyxiation gases,” as well as a furnace or oven room, from where a railway track led to the cemetery. What purpose, then, did the ovens serve?

On the other hand, was not the bathing room identical to the room for testing asphyxiation gases (why, actually, a “testing room”?) and therefore necessarily a real bath, through which the deportees walked before they were lodged in one of the three camps mentioned above? But the dressing room, as well as the ovens, is not compatible with the extermination thesis, and indeed even less so with the version accepted today, for on the one hand the doomed are supposed to have undressed in the open, and on the other hand no historian claims that there were crematoria in Treblinka. If one views the entire facility within another context, a medical-hygienic one, then the description proves to be a completely logical one. In a facility, which includes a dressing room and a bathing room, a furnace (or oven) room can contain nothing but a delousing

⁹⁰¹ See Document 3 in the Appendix.

⁹⁰² See Chapter II.

furnace, but then the adjacent room was definitely not a “room for testing asphyxiation gases,” but rather a disinfection/hot-air chamber. (In this connection, it is worth mentioning that the supposed ‘extermination camp’ of Chełmno was also equipped with a delousing furnace.)⁹⁰³

Such disinfection furnaces were produced by several firms, among them the Topf firm in Erfurt, which installed two of them (with four hot-air chambers) in the central sauna in Birkenau,⁹⁰⁴ and the firm of H. Kori in Berlin, which produced less well-built ovens.⁹⁰⁵ One other firm, which produced hot air, steam, and steam/formalin delousing chambers as well as similar installations, was the Ing. C. Klobukowski & Co., located in Warsaw.⁹⁰⁶

The description and drawing contained in the Silberschein Report are reminiscent of the plan of the provisional delousing facility of the K.G.L. Lublin. This facility had rooms for dressing and undressing, a boiler house (boiler room), a room with showers (bath), and a room for delousing (“room for testing asphyxiation gases”).

Reitlinger writes that some children transferred in August 1943 from the ghetto of Białystok to Theresienstadt

*“had seen their parents led away to a ‘bath-house’.”*⁹⁰⁷

Since these children were processed through the transit camp Treblinka – the same was true for the other Jews, adults, and children who were transferred to Lublin/Majdanek and other camps – this bathhouse was obviously a genuine bathhouse!

The structure of the two alleged gassing installations, however, which has been accepted by official historiography, seems to have been more suited for hydrocyanic delousing chambers. In both, the chambers have two doors on the two opposing sides of the room, so that there is a ‘clean’ and ‘unclean’ side. In this connection, Kurt Gerstein’s mission acquires an obvious meaning. Gerstein was no expert in mass killings, but he was one in the field of disinfection, and indeed so well qualified in such matters that in the foreword to his book on disinfection, published by the Waffen-SS Hygiene Institute, the *SS-Hauptsturmführer* d. Res. Walter Dötzer expressed his gratitude to him:⁹⁰⁸

“I should express my thanks to SS-Obersturmführer (F) Dipl.-Ing. [graduate engineer] Gerstein at this point for his advice in all technical questions.”

This furnishes an uncontrived explanation for Samuel Rajzman’s reference to “Cyklon-Gas” – Zyklon B gas – in Treblinka. As Mieczysław Chodzko re-

⁹⁰³ T-1298.

⁹⁰⁴ RGVA, 502-2-27, pp. 24-24a. Final account statement No. 1792 of October 19, 1943.

⁹⁰⁵ See J. Graf, C. Mattogno, *op. cit.* (note 270), Document 29, p. 320.

⁹⁰⁶ Undated advertising brochure. DAL, R-35-9-443, pp. 1-12.

⁹⁰⁷ G. Reitlinger, *op. cit.* (note 180), p. 307, footnote.

⁹⁰⁸ W. Dötzer, *op. cit.* (note 899), p. II.

ports, a public health commission brought disinfection equipment and mobile ovens for heating water for the showers to Treblinka in November 1942.⁹⁰⁹

In January 1942, there was already great anxiety concerning sanitation and hygienic conditions in the district of Galicia.⁹¹⁰ Cases of typhus fever had appeared in the district of Kolomyia,⁹¹¹ but other districts were probably also afflicted, so that the governor instructed all district physicians to answer a “questionnaire concerning bathing and delousing facilities.”⁹¹² Among the various delousing facilities was even a “fumigation booth for scabrous horses.”⁹¹³ The situation was becoming critical to the point that placards in German, Ukrainian, and Polish were posted, warning about typhus fever. These had been designed by the “District Administrator in Tarnopol. Dept. of Health” and explained the type and danger of the epidemic and the necessity of combating its carriers: “Without lice there is no typhus fever. Fight lice infestation!” Then it warned:

“A large part of the population, but most of all the Jews, is infested with lice!”

The text of the placard closed with the admonition to see a physician at the first sign of symptoms of the disease.⁹¹⁴

The resettlement to the east of the Jewish population of the General Gouvernement, which had been living in the ghettos under difficult hygienic circumstances, therefore required transit camps with bathing facilities, disinfection, and delousing.

5. What Was the Fate of the Deportees?

The fate of the Jews deported to the east is one of those questions for which there is no sure answer, due to the lack of documents. It is closely bound up with the even more complex problem of Jewish population losses during World War II, which is not the subject of the present study.⁹¹⁵

⁹⁰⁹ Wydawnictwo Centralnej Żydowskiej Komisji Historycznej (ed.), *Dokumenty i Materiały*, *op. cit.* (note 39), p. 176.

⁹¹⁰ Letter of January 19, 1942, of the Kreishauptmann of Horodenka on the subject of “Delousing Facilities”. DAL, R-35-9-313, p. 3.

⁹¹¹ Letter of 5 February 1942 of the *District Physician* in Kolomyia on the subject of “Typhus Fever in the District”. DAL, R-35-9-313, p. 1.

⁹¹² DAL, R-35-9-320, pp. 1, 5. R-35-9-313, p. 16.

⁹¹³ DAL, R-35-10-452, page number illegible.

⁹¹⁴ Poster “Fleckfieber!” (typhus) DAL, R-35-9-444, p. 2.

⁹¹⁵ The most comprehensive studies on this question are: on the side of the orthodox historians, the anthology *Dimension des Völkermords*, edited by W. Benz, *op. cit.* (note 79), and, from the revisionist side, W. Sanning’s *The Dissolution of Eastern European Jewry*, *op. cit.* (note 78). A comparison of the two works has been undertaken by Germar Rudolf: “Holocaust Victims: A Statistical Analysis. W. Benz and W. N. Sanning – A Comparison”, *op. cit.* (note

As we have seen in Chapter VII, the figures for Jews killed by the *Einsatzgruppen* according to the ‘Event Reports’ – or other sources – are vastly exaggerated, so that the number of Jews who either were evacuated by the Soviets or who survived in the German occupation zone must have been far larger than the 700,000, of which G. Reitlinger speaks.⁹¹⁶ A Soviet source is emphatic on the evacuation of large numbers of Jews to safety within the USSR:⁹¹⁷

“When Hitler invaded Poland in the year 1939, tens of thousands of Polish Jews fled to eastern Poland, from where they later reached the Soviet Union. Together with the population of the Ukraine and White Russia, these Jews were the first who were evacuated to the east. Since the authorities knew that the Jews were the most critically threatened portion of the populace, they made thousands of trains available for their evacuation. In Zhitomir 88% of the Jews left the city, even before the Nazis arrived there. Special effort was expended to save the Jewish kolkhoze peasants; many of them were evacuated in the Crimea under circumstances, which permitted them to take along all their cattle, together with farm implements. In an article that appeared in 1942 in ‘Congress Weekly,’ a New York Zionist paper, the Palestinian Jew Solomon Itzhaki gave the grateful account of a Polish-Jewish journalist about his own evacuation. During a five or six week journey, food, clothing, and special help for children and the ill were made available by the Soviet government. According to this journalist, millions of evacuees, Jews and non-Jews, were quickly accommodated after arrival at their destination, received a profitable job in the war industry, and were assigned to agricultural operations. While a large number of Polish Jews performed splendid work in the Soviet war industry, the Polish-Jewish youth attended the Soviet schools by the thousands. Hundreds studied at the University of Leningrad – shifted to Saratov during the war – where they slept in dormitories provided by the government and were fed in special canteens. All ‘Yeshivas’ (Talmud seminaries) were moved from eastern Poland to central Asia at the cost of the Soviet government. The refugee rabbis carried on their clerical activity, and Michail Kusevitski, master cantor of the Great Synagogue of Warsaw, went on a concert tour through the Soviet Union, in which he profoundly moved soldiers as well as civilians with his singing of ‘Kol Nidre,’ a solemn prayer for the Jewish Day of Atonement. The majority of the Jews evacuated from the zones occupied by Germany went to Uzbekistan. Many other Jewish families were taken in by the autonomous Soviet Socialist Republic of Bashkiria in the Urals. According to Abdul Akhmetov, the Bashkirian vice-

80).

⁹¹⁶ G. Reitlinger, *op. cit.* (note 180), p. 542f.

⁹¹⁷ *Rassenga sovietica*, August-September 1951, pp. 77f.

commissar for Agriculture, the evacuees worked side by side with the Bashkirians on the kolkhoz fields and performed 'outstanding labor.' A certain portion of Jewish kolkhoz peasants from the Ukraine settled in the area of Saratov in their own kolkhoz. Thousands of other Jews, among them many elderly people from Vitebsk, Kiev, and Riga, found employment in the factories and textile industries of the same region."

Kulischer reckons the number of the Jews who fled from the eastern Polish provinces into Soviet territories, which never came under German control, at 500,000; to this are to be added 30,000 Jews from the Baltic states and 1,100,000 Jews from the Soviet territories who left before the Germans conquered these areas.⁹¹⁸

In an Italian study entitled "The Jews in the USSR," one reads:⁹¹⁹

"The Baltic states, White Russia, and the Ukraine suffered especially severe losses. A certain number of refugees of the war period settled in central Asia, so that the present [1966] Jewish population of Uzbekistan consists of old Jewish inhabitants of Bukhara and immigrants from the European territories. Others settled in various cities of the Urals as well as Siberia or were evacuated there. Of the refugees, some returned to their former place of residence after the war, others stayed, which explains the large number of Jews in towns like Sverdlovsk and Cheliabinsk."

The Jewish journalist Louis Rapoport draws a decidedly more pessimistic picture; he writes:⁹²⁰

"Of the approximately one million Polish Jews sent into the Urals and Siberia – the journey lasted four to six weeks and proceeded under horrific conditions – a fifth to a third died, according to a news sheet of the Joint Distribution Committee from the year 1943."

For the period from March to September 1946, "when the homeward trek from the deep interior had only begun," Reitlinger supplies Jewish population figures for five Soviet cities, which are not too far below the pre-war numbers. Reitlinger took these figures from an article in the Soviet Yiddish language newspaper *Ainikeit*, whose date of appearance he does not give:

⁹¹⁸ E. Kulischer, *op. cit.* (note 799), tables entitled "General survey of population displacements in Europe since the beginning of the war", outside the text.

⁹¹⁹ *Gli Ebrei nell'USSR*, Milan 1966, p. 51.

⁹²⁰ Louis Rapoport, *La guerra di Stalin contro gli Ebrei*, Rizzoli, Milan 1991, p. 87.

CITY	JEWISH PRE-WAR POPULATION ⁹²¹	JEWISH POSTWAR POPULATION ⁹²²
Kiev	140,000	100,000
Odessa	153,000	80,000
Dniepropetrovsk	62,000	50,000
Vinnitsa	21,800	14,000
Shitomir	30,000	6,000
Totals:	406,800	250,000

There is no doubt that a large percentage of the Jews in the Soviet territories, which came under German control during the war, died, not only in massacres, but also due to military action, sickness, exhaustion, and privation. A tragedy – in view of the fact that most of these Jews were elderly, children, or infirm – of which there is no doubt.

Germar Rudolf subdivides the Jewish losses into the following categories:⁹²³

- death from Soviet deportation and imprisonment;⁹²⁴
- death due to pogroms by non-Germans, without German collaboration or sanction;
- death due to effects of war (labor service, bombing victims);
- death as a soldier (*i.e.*, in military service);
- death as a partisan (in combat or by execution);
- natural mortality surplus;⁹²⁵
- religious conversions;
- unregistered emigration during and after the war;
- Jews presently not recorded or statistically documented;
- unresolved cases;
- death (for the most part natural) in ghettos⁹²⁶ and camps (several hundred thousand);
- registered emigration during and after the war.

⁹²¹ Friedrich Zander, *Die Vertreibung der Juden in der Welt*, Robert Kämmerer Verlag, Berlin 1937, p. 68.

⁹²² G. Reitlinger, *op. cit.* (note 180), p. 545.

⁹²³ G. Rudolf, "Holocaust Victims: A Statistical Analysis," *op. cit.* (note 80), p. 205.

⁹²⁴ As we have seen, according to L. Rapoport 200,000 to 300,000 evacuated Polish Jews met their death in the USSR.

⁹²⁵ According to the Korherr Report, in Germany proper, the Sudetenland, Austria, and Bohemia and Moravia, the Jewish surplus mortality up to December 31, 1942, amounted to 82,775. NO-5193, p. 4.

⁹²⁶ During the war 33,430 Jews died in Theresienstadt. *Das Ghetto Museum Theresienstadt*, edited by the Gedenkstätte Terezin (Terezin Memorial), undated, p. 37 (our own page enumeration). – In the ghetto of Lodz 47,372 Jews met their death. Julian Baranowski, *The Lodz Ghetto 1940-1944. Vademecum*. Archiwum Państwowe w Łodzi, Lodz 1999, pp. 86f. – In the Warsaw Ghetto the number of those who died from January 1942 to June 1942 was 69,355. *Faschismus – Getto – Massenmord*, *op. cit.* (note 289), pp. 138f.

Of course, the Jews shot by the *Einsatzgruppen*, the Wehrmacht, etc. are to be added to this. It is an impossibility to assign exact numbers to each of these categories, but the few examples cited here do provide a notion of how high were Jewish losses from causes other than German killing measures.

The official population statistics of the postwar period give no additional help. First of all because they come from the Jewish and Stalinist side and thus were inevitably influenced by the demands of ideology and propaganda, second because they do not allow for substantial factors such as emigration to other countries, assimilation, or simply the desire of many Jews not to be registered as such.

In 1984, an Italian Communist newspaper explained the reduction of the Jewish population in the Soviet Union, which had been reflected in the censuses of 1926, 1970, and 1976, as follows:⁹²⁷

“The decrease of the Jewish population in comparison with the year 1926 is in part the result of the Nazi policy of extermination, partly traceable to the natural process of assimilation in a country, which numbers more than a hundred different nationalities and where there is no impediment to mixed marriage. The shrinkage of the Jewish population in the decade 1970-1979 is the result of the same assimilation process (in the USSR citizens declare their nationality by their own choice by choosing one of the two nationalities of their parents), but also the emigration of those Jews who have gone abroad within the framework of the Soviet policy, which favors the reuniting of families separated by the most diverse sorts of circumstances.”

Insofar as the first postwar census, that of 1959, is concerned, citizens could declare their nationality without having to produce their ID, on which their nationality was officially registered. For this reason, numerous citizens preferred, for various reasons, to assume a different nationality.⁹²⁸ Together the other factors already mentioned, this has contributed to producing a distorted picture of the numerical strength of the Jews in the USSR.

⁹²⁷ *Calendario del popolo*, No. 468, July 1984, pp. 10247.

⁹²⁸ *Gli Ebrei nell'USSR*, Milan 1966, pp. 55f.

Chapter X: Conclusion

In 1987, Robert Faurisson wrote the following noteworthy lines:⁹²⁹

“‘Shoah’-business will continue to prosper. The Holocaust Museums are going to multiply and Holocaust propaganda will continue to invade the high schools and universities. The concentration camps will become attractions comparable to Disneyland. [...] Tour operators are beginning to calculate the profit they can derive from these places, at which there is in reality nothing to see but where, as a result, they will fill the void with ‘symbols.’ The less there is to see with your eyes, the more they will give you to see in your imagination. From that point of view, Treblinka is an ideal place. Everything there is symbolic: the entrance to the camp, its boundaries, the railway line, the access ramp, the path to the ‘gas chambers,’ the ‘open air funeral pyres,’ and the sites of the ‘chambers’ and ‘funeral pyres.’”

Yes, Treblinka is, in fact, the most fitting landmark of the ‘Holocaust,’ a mirage of a million-fold genocide in gas chambers, of which not the slightest documentary or material trace exists and about which we would know nothing without the tales of a handful of ‘eyewitnesses’ – in sharp contrast to the real, irrefutable suffering of the Jewish people during the Second World War.

It is deeply symbolic that the most important Treblinka ‘eyewitness’ by far, Jankiel Wiernik, and the most prominent representative of all of the orthodox historiography about that camp, Yitzhak Arad, are blatant falsifiers. By means of a bold manipulation of the November 15, 1942, report produced by the resistance movement of the Warsaw Ghetto, in 1944 Wiernik converted the embarrassing ‘steam chambers,’ which characterize the first phase of the Treblinka atrocity propaganda, into ‘gas chambers,’ and thereby laid the cornerstone for the legend of the ‘gas chambers of Treblinka,’ which were subsequently transmogrified by orthodox historiography into ‘established historical fact.’ But compared to this harsh judgment on the Jewish cabinetmaker from the Warsaw Ghetto, we must come to an even harsher judgment on the Israeli Professor Arad, who is guilty of the gravest of all offenses against the commandments of scientific ethics: the conscious falsification of source material.

That Jewish circles, above all others, defend the historically and technically absurd story of ‘extermination camp’ Treblinka with tooth and claw can be

⁹²⁹ Robert Faurisson, “My Life as a Revisionist,” *The Journal of Historical Review*, Vol. 9, No. 1, pp. 5-63, here p. 58.

explained without difficulty by the pressures, to which these people are subjected.

From the beginning of the ‘Holocaust’ propaganda, Auschwitz has had first rank and Treblinka second; there has always been far less discussion of the other four ‘extermination camps.’ Since the end of the sixties, the flagship of the Holocaust Armada, Auschwitz, has been under an uninterrupted barrage from revisionist researchers. Due to this pressure – invisible to the public but enormous – the advocates of the orthodox version of history have been constrained to keep reducing the number of victims of this camp. In 1990, the administration of the Auschwitz Museum withdrew the four million figure of Auschwitz victims – which had in any case never been accepted by Western historians – and replaced it with one and a half million; in 1994, Jean-Claude Pressac, celebrated by the media as the leading Auschwitz expert, again reduced the number drastically, to between 631,000 and 711,000.⁹³⁰ The latest retrenchment of the front in this ongoing retreat came in May of 2002, when Fritjof Meyer, one of the editors of Germany’s largest news magazine, *Der Spiegel*, wrote in the geopolitical German magazine *Osteuropa*, with reference to allegedly new research results, that ‘only’ half a million died in Auschwitz, which is still an exaggeration by at least a factor of three.⁹³¹

An even more drastic revision has been achieved for Majdanek: in 1944, the figure of one and a half million murdered was given for that camp; in 1948, Polish historiography set the total number of victims at 360,000; but at the beginning of the nineties, the number was reduced to 230,000;⁹³² Raul Hilberg assumes in his standard work that only 50,000 Jewish prisoners were killed in Majdanek.⁹³³

According to the laws of mathematics and sound human reasoning, this massive reduction in the number of victims for Auschwitz and Majdanek should have resulted in a corresponding reduction in the total number of ‘Holocaust’ victims, but no: the mythical six million figure must be upheld at all cost!

⁹³⁰ Jean-Claude Pressac, *Die Krematorien von Auschwitz*, Piper Verlag, Munich/Zürich 1994, p. 202. Cf. also the overview concerning the number of dead of Auschwitz by Robert Faurisson, “How Many Deaths at Auschwitz?”, *The Revisionist*, 1(1) (2003), pp. 17-23.

⁹³¹ Fritjof Meyer, “Die Zahl der Opfer von Auschwitz. Neue Erkenntnisse durch neue Archivalien,” *Osteuropa. Zeitschrift für Gegenwartsfragen des Ostens*, No. 5, May 2002, pp. 631-641; cf. Germar Rudolf, “Cautious Mainstream Revisionism”, *The Revisionist*, 1(1) (2003), pp. 23-30; Carlo Mattogno, “Auschwitz. The New Revisions by Fritjof Meyer,” *ibid.*, pp. 30-37.

⁹³² Cf. for this Jürgen Graf, Carlo Mattogno, *op. cit.* (note 270), Chapter IV.

⁹³³ Raul Hilberg, *op. cit.* (note 17). If one subtracts from this figure the confabulated 18,000 victims of the alleged mass shooting of November 3, 1943 (“Harvest Festival,” cf. with regard to this Jürgen Graf, Carlo Mattogno, *Concentration Camp Majdanek*, *op. cit.* (note 270), Chapter IX), Hilberg’s number for the Jews killed in Majdanek is only slightly exaggerated.

Under these circumstances, the proponents and beneficiaries of the official historiography can never give up the ‘extermination camp’ Treblinka, with its 750,000 to 870,000 people ‘gassed,’ since to do so would amount to a final dismantling of the current version of the fate of the Jews during World War II. And the other ‘pure extermination camps’ – Bełżec, Sobibór, and Chełmno – for which the evidentiary material presented is of similar ‘quality,’ would have to take their leave from real history together with Treblinka.

That the official view of Treblinka increases respect for the Jewish people can be justly questioned, for one of the cornerstones of this picture is the slavish cooperation of the victims with their executioners. Does it really do credit to Jewish honor if their fathers and grandfathers marched into the gas chambers of Treblinka like a herd of sheep, without giving a thought to escaping or resisting? Can one feel respect for the 1,000 Jewish workers of Treblinka, who – always according to the orthodox version of history – assisted the 30 to 40 SS people and 120 Ukrainians day after day in murdering many thousands of their co-religionists, never warned them of the fate awaiting them, and acted as loyal accomplices to their tormentors to the very end, in full awareness of their own impending death?

The American revisionist Bradley R. Smith has commented upon the appearance of the barber Abraham Bomba in Claude Lanzmann’s film *Shoah*, in which Bomba describes how he cut the hair of 60 to 70 naked women in the 16-square-meter large gas chamber of Treblinka. After Lanzmann had asked Bomba what he felt when he saw all these naked women for the first time, the barber replied:⁹³⁴

“I felt that accordingly I got to do what they ... [Germans] ... told me, to cut their hair.”

Smith says in response to this:

“There you have in a nutshell how eyewitnesses to the gas chamber atrocities typically describe their behavior. They did whatever the Germans or anyone else requested of them. [...] In the neighborhood where I grew up men who behaved like Bomba claims he behaved would have been spit on. In the upside-down world of Holocaust survivordom, however, the Abraham Bombas are seen as martyrs and even heroes.”

Historians who are interested in facts will not allow themselves to be deterred from pursuing the many still open questions of Treblinka by Bomba’s monstrous fantasies. Above all, it is entirely unclear where the Jews deported to Treblinka ultimately wound up. That Treblinka served as a transit camp is proven, but for the most part we are still in the dark as to the details (the number of those resettled, their destinations, and their fate during the war and afterwards). In coming years, it is to be hoped that the improving access to ar-

⁹³⁴ Bradley R. Smith, “Abraham Bomba, the Barber of Treblinka”, in: *The Revisionist*, 1(2) (2003), pp. 170-176.

chives in the successor states of the Soviet Union will make it possible for researchers to shed more and more light into this darkness. When we speak of researchers, we of course mean the revisionists, for their opponents will hardly be doing such work.

Epilogue

By Germar Rudolf

“How can anybody seriously believe that the Holocaust did not happen? Considering all the witnesses, all these pictures, all the documents, how could all this be lies and forgeries? And how could anybody with all his senses believe that such a thing could be made up? Thousands of historians and other researchers, hundreds of prosecutors, judges, and jurors – are they all wrong? Or did they all conspire in an incredible meeting of minds, a consensus of mind-reading?”

These or similar questions will pop up in most people’s minds when they are confronted with revisionist theories for the first time. In fact, most revisionists posed these questions at the beginning of their journey from exterminationist Sauls to revisionist Pauls.

Even I, as the editor of this series of revisionist books that I started several years ago, catch myself doubting my revisionist convictions every once in a while. I find myself asking questions similar to those above. But among my professional duties (and intellectual pleasures) is editing books written by fine revisionist scholars – like the authors of the present book. In 2002 I first edited it in the German language, and now, some 18 months later, a second time for the English language edition. Though this book was not specifically written to answer the questions of the Doubting Thomases, which at times we all are, and gladly so, it caused me, once again, to ask quite different questions, and I hope that the reader has had a similar experience while reading this fine work:

“How can anybody seriously believe that the Holocaust did happen? Considering all the absurdities, impossibilities, contradictions, how could all these witness tales ever be believed? And how could anybody with all his senses believe that such a thing could have happened? Thousands of historians and other researchers, hundreds of prosecutors, judges, and jurors – have they all lost their minds? Or were they all so brainwashed by wartime propaganda or trembling in fear of the Jews that they did not dare rock the boat?”

Of course, reading this book need not lead to such a reaction. Fritjof Meyer, for example, reacted quite differently. For many years, he was a leading editor of Germany’s biggest weekly news magazine, *Der Spiegel*, a dedicated left-wing medium that has always promoted the orthodox version of the Holocaust with verve, and still does. Meyer can perhaps be described as one of Germa-

ny's media experts on this topic. He is also a dedicated purchaser and reader of all revisionist publications, as Castle Hill Publisher's database indicates. Meyer attracted some attention in 2002, when he published an article in a small German geopolitical magazine, in which he reduced the Auschwitz death toll considerably, to about 500,000, based on a strange mixture of revisionist and exterminationist arguments.⁹³¹

Several weeks after the German version of the present books was sent to Meyer, he reacted with a short email, as always indicating that his statements were not for publication. I therefore will quote them only indirectly. I do this, because it is necessary to show that:

- a. mainstream scholars do pay attention to revisionist research;
- b. they dare to enter into exchanges with revisionists;
- c. they are not courageous enough to do so in public.

In his statement, Meyer says that it was time that finally somebody gathered all the information about a topic, which had been neglected for a long time, and he praises the industry, with which the two authors added interesting discoveries from Polish archives. He regrets, however, that in his eyes this book serves only to support the authors' dogma instead of balancing the pros and cons in an unbiased way. He then claims that the authors omitted everything that would not fit into their image of Treblinka.

First of all, I would like to address the harsh accusation that the authors sought only to confirm their own dogma. If Meyer cared to define what a dogma is, then he would have to admit that the official version of Holocaust bears *all* the characteristics of a dogma: all dissenters are severely punished by the society at large and in many countries, particularly in Europe, even by the authorities, by means of political show trials. The dissenting view presented in this volume is the opposite of the dogma: it is a challenge to the dogma.

It is also incorrect that the authors have ignored everything that contradicts their thesis. How can anybody claim that a book, which dedicates most of its pages to discussing the 'orthodox,' dogmatic version and most of its arguments, is omitting contradictory evidence? To be sure, no author is omniscient, hence no book is perfect. But in contrast to Meyer, who has never discussed opposing arguments and publications in his papers, Mattogno and Graf made an honest attempt to cover all the existing material.

Let me now address some of the points Meyer raised.

1. Use of Euthanasia Staff during Operation Reinhardt

In discussing the postulated murder of the Jews in the so-called Operation Reinhardt camps, of which Treblinka was the largest, historians of the status quo locate the technical and organizational origins of this mass murder in the euthanasia program, which was instituted at the beginning of World War Two – the killing of so-called 'life not worthy of life,' in other words, mentally

and/or severely physically disabled people. The reason for this assumption is the considerable overlap, *i.e.*, continuity, of staff in both areas.⁹³⁵ However, it seems to me a very dubious practice to attempt to construe this continuity as evidence for mass murder, since it may very well mean only that the leadership had wished to retain staff, which had previously proven loyal in one socially extremely controversial operation, for a subsequent, no less controversial purpose. But whether this controversial purpose was the resettlement, ghettoization, or mass murder of the Jews is still an open question.⁹³⁶

There is, of course, an answer to this question, and it lies in the fate of many of the staff members involved in Operation Reinhardt after the eastern camps were closed.⁹³⁷ Globocnik and the major part of his team of Operation Reinhardt were transferred to the Adriatic coast of northern Italy in late 1943. Globocnik became “*Höherer SS- und Polizeiführer in der Operationszone Adriatisches Küstenland*” (Higher SS and police leader in the operational zone Adriatic coast) under direct orders of the Führer Chancellery.⁹³⁸ His staff was turned into a unit called “*R*” (probably for Reinhardt) engaged mainly in anti-partisan warfare, but to a minor degree also in the organization and deportation of Italian Jews to forced labor assignments in Germany. In this connection, a transit camp for the deportation of Jews was established in Risiera di San Sabba. Liliana Picciotto-Fargion writes in the regard:⁹³⁹

“The mechanism [of deportation] is not very different at the Adriatic coast: the prison of Coroneo di Trieste acted as a collection point for the deportations between December 1943 and March 1944 and was then replaced by the collection and transit camp located in Risiera di San Sabba (Polizeihaftlager).”

The author adds that one convoy of deportees from Italy included on average 500–600 persons,⁹³⁹

“while those coming from the Nazi operational zone Adriatic coast (Operationszone Adriatisches Küstenland), with ‘capital’ Trieste, had on average only around 60–80 persons per convoy.”

⁹³⁵ K. A. Schleunes, in E. Jäckel, J. Rohwer, *op. cit.* (note 275), p. 70ff., esp. p. 78. For a list of personnel who served in the Operation Reinhardt camps, their prior deployment in the euthanasia program, as well as their military ranks, see www.deathcamps.org/reinhardt/completestaff.htm.

⁹³⁶ If Meyer had paid attention, he would have found this observation in my 1994 book *Grundlagen zur Zeitgeschichte*, *op. cit.* (note 97), p. 25, Engl.: Germar Rudolf (ed.), *Dissecting the Holocaust*, *op. cit.* (note 80), p. 33.

⁹³⁷ I owe the following information to my dear friend Carlo Mattogno.

⁹³⁸ Pier Arrigo Carnier, *Lo sterminio mancato. La dominazione nazista nel Veneto orientale 1943-1945*. Mursia, Milano 1982, pp. 55, 66; see pp. 400f. for some members of the staff.

⁹³⁹ L. Picciotto-Fargion, *Il libro della memoria. Gli Ebrei deportati dall'Italia (1943-1945)*, Mursia, Milano 1995, p. 35.

23 such convoys with a total of 1,173 Jews departed from this zone, most of them with the destination of Auschwitz.⁹⁴⁰

There is no doubt that the camp at Risiera di San Sabba was *not* an ‘extermination camp,’ and it is also clear that the main activity of Globocnik’s unit “R” was to fight partisans. Therefore, we have clear proof of deployment of the former staff of both euthanasia and Operation Reinhardt in a task that had nothing to do with the extermination of Jews. Thus, the fact of partial continuity of the personnel employed in the euthanasia with that employed in the Operation Reinhardt does *not* permit the conclusion that Jews were summarily exterminated in the Operation Reinhardt camps.

Moreover, Meyer’s claim that not only the euthanasia staff was transferred, but also their methods and equipment (gassing with carbon monoxide), is simply wrong. There is no evidence that the method used for killings during the euthanasia program – mainly bottled carbon monoxide – was ever used during the alleged Holocaust. Here we find claims to all sorts of methods, *except* the one used during euthanasia, which had proven to be highly effective. Today, Meyer and his fellow dogmatists claim that the exhaust of diesel engines was used to kill people in Treblinka and Bełżec. Fritz Berg has shown in detail how absurd this claim is, indeed.⁹⁸ It is not only absurd because diesel exhaust gases hardly contain any carbon monoxide, but even more so because the Germans had an overabundance of extremely poisonous devices available: hundred thousands of wood and coke gas generators, which were cheap and easy to operate and delivered a gas just as lethal as bottled carbon monoxide.

Considering that some of the staff of Operation Reinhardt had knowledge of homicidal techniques from the euthanasia program, this *lack* of transfer of method is strong circumstantial evidence that the Operation Reinhardt did *not* mean the killing of people.

2. Archaeological Findings

Meyer criticizes the alleged lack of discussion of archaeological findings, such as the fact that today the rain still rinses bone fragments to the surface. Since archaeological findings are discussed in detail in Chapter III.2. of the present book, one wonders if Meyer really read this book thoroughly. Also, when talking about archaeology, Meyer should first ask why the huge mass graves attested to by the witnesses were never found *despite* archaeological research. Bone fragments rinsed to the surface prove that people died in Treblinka and were buried, a fact that nobody denies, but such findings do not prove a mass murder with the methods and the order of magnitude claimed. Unless Meyer has established the extent and nature of bone fragments and of the area, in which they can be found, his statement cannot be called an archaeological finding, but merely an unfounded claim.

⁹⁴⁰ *Ibid.*, pp. 60-63. The average would thus be 51, not 60-80.

The more-recent investigations by Caroline Stury Colls, as they are discussed in the next contribution by Thomas Kues, haven't changed anything about this either. Finding disturbances in the soil with ground-penetrating radar merely proves that the soil has been disturbed there. Whether these were ever mass graves can be determined only by extended core drillings and excavations.

3. Testimonies of SS Witnesses and of Prof. Pfannenstiel

Meyer criticizes the authors for dismissing the testimonies of SS personnel and of Prof. Pfannenstiel as mere tactical lies. It seems that it is Meyer who needs to be straightened out here: If a forensic blood analysis shows that a defendant was drunk at the time of a car crash, one million witness statements and one million confessions of the defendant, all claiming that the defendant was, in fact, not drunk, cannot change the fact that he *was* drunk. Thus, if one hundred witnesses and one hundred confessions state that the moon is made of green cheese or that 870,000 corpses can be burned within a few months without fuel and without leaving traces, both assertions being of a similar intellectual quality, then we have to conclude – in light of all the forensic evidence – that the witnesses and the defendants are wrong. Like it or not! Thus, unless Meyer proves that the factual claims of the witnesses were physically possible, we do not have to discuss whether such witness statements are correct, only *why* they are *incorrect*. To the solution of this question Meyer contributes nothing.

In this context, I may add one point that is often forgotten today: When the German Army invaded the Soviet Union with the Christian crosses of the Wehrmacht as their emblem, the population greeted them enthusiastically – and naively – as God's own soldiers come to liberate them from the devilish Soviet mass murderers. Even the NKVD admitted, in secret reports, that vast parts of the local population of many regions viewed the Germans as liberators from Stalinist oppression, that the Germans treated the local populace well and turned many of the younger people into dedicated National Socialists eager for close collaboration with the Germans.⁹⁴¹ It can thus come as no surprise that the largest volunteer army that ever fought for a foreign nation was that which, consisting of over one million young people mainly from Eastern Europe, fought alongside the Wehrmacht, because these young people saw the German war against the Soviet Union as a cause worth sacrificing their lives for. However, when the Germans started to retreat in 1943, many among the local population, knowing what awaited them, tried to move west with the Germans, and were prevented from doing so only by drastic German measures. After the Red Army reconquered those temporarily liberated territo-

⁹⁴¹ Cf. Alexander E. Epifanow, Hein Mayer, *Die Tragödie der deutschen Kriegsgefangenen in Stalingrad von 1942 bis 1956 nach russischen Archivunterlagen*, Biblio, Osnabrück 1996.

ries, the Soviets conducted draconian purges against the local population, conducting show trials of uncounted individuals for actual or alleged collaboration with the Germans. In some regions, where collaboration was very intensive, in particular in the Baltic states, the Caucasus region, and the Ukraine, considerable portions of the population were deported to Siberia as a collective punishment.⁹⁴² Not even those who had been incarcerated in various German camps were safe from this kind of treatment, especially if former co-inmates accused them of having aided the Germans in running the camp.

The only way to prevent deportation to a Siberian labor camp – an almost certain death sentence – was to bend over backwards to comply with Soviet demands by denouncing the former German occupiers and helping in manufacturing evidence for actual or alleged German atrocities and war crimes. It is more than likely that many of the ‘eyewitness’ accounts collected by Soviet Russian or Polish commissions have their origin in this hysterical atmosphere of postwar purges.

A similar atmosphere was prevalent in the areas occupied by American and British troops, although not as intense, and whereas this atmosphere subsided by the end of the 1940s/early 1950s in the West – only to be gradually substituted with a hysterical ‘Holocaust’ atmosphere created by media and courtroom propaganda – it remained a permanent background theme in the communist East as a tool, with which to denounce and destabilize the ‘revanchist,’ ‘fascist’ West, especially its client state West Germany, as NATO’s most crucial and also most vulnerable member during the Cold War.⁹⁴³

4. Deportation Data

Meyer claims that the Jewish Historical Institute (Żydowski Instytut Historyczny) of Warsaw has precise data about the deportation of Jews to the Operation Reinhardt camps. This institute published a *Biuletyn* (bulletin) that has included archival material on the alleged extermination of Jews. The first issue appeared in 1951. Jürgen Graf and Carlo Mattogno have examined all the issues of this bulletin in search of archival material, above all deportation lists, useful for their research on Majdanek and on the eastern camps. Mattogno claims that the bulletin does not contain a single such list, nor is any to be found in the Institute’s archive. Articles published in its bulletin that are important in the context of this topic are listed in the bibliography of this book. Not even the book *Faschismus-Getto-Massenmord*,²⁸⁹ which was published by the same institute and which contains the better part of the documentation pre-

⁹⁴² See, for example, the treatment of the Caucasian peoples: Ataullah B. Kopanski, “North Caucasia’s Anno Horribilis, 1944,” *The Barnes Review*, 4(4) (1998), pp. 37-40.

⁹⁴³ To learn more about the circumstances, under which testimonies and confessions were made, cf. G. Rudolf, “The Value of Testimony and Confessions Concerning the Holocaust,” in: G. Rudolf (ed.), *op. cit.* (note 80), pp. 83-127.

served in its archives, includes any deportation lists. While in Moscow, Graf and Mattogno verified the sources of Tatiana Berenstein's article "*Eksterminacja ludności żydowskiej w dystrykcie Galicja*".⁷⁸⁵ Her article turned out to be based entirely on testimonies – confirming that the archive of the Jewish Historical Institute contains no deportation lists to the eastern camps.

5. Conclusions

Meyer makes a few other points, which I cannot address here because I either do not know what he refers to or why he thinks certain arguments put forward by the authors are flawed. Meyer has not yet elaborated on his criticism, but he has promised to publish his own paper on this topic and to inform us about it. So far, however, we have not heard back from him.

It is encouraging that finally at least one scholar of the other side of this debate takes scientific standards seriously and takes notice of the need to address the many urgent questions raised by books like the present one. We can only hope for historiography in general that this will not be an isolated case, but that other scholars will be encouraged thereby to dare to voice their own doubts and opinions, because exactitude is the only certain way to the truth, and exactitude can only be achieved when we make each other aware of the mistakes we all make.

In closing, I may point the reader's attention to an article by Prof. Dr. Robert Faurisson, which he wrote after reading the German edition of the present book: "Treblinka: An Exceptional Guide."⁹⁴⁴ In it Dr. Faurisson describes his own visit to Treblinka in 1988 and the interviews he conducted with two local witnesses. Since neither witness signed an affidavit, and no other record of their testimony seems to exist, and because their testimony was given some 35 years after the fact, it was decided not to include Dr. Faurisson's hearsay report of eyewitness accounts in this book, because its evidentiary value is rather low. But the interested reader might nevertheless enjoy reading what Dr. Faurisson learned and experienced with those two witnesses.

⁹⁴⁴ R. Faurisson, "Treblinka: An Exceptional Guide," *The Revisionist*, 2(1) (2004), pp. 78-82.

Supplement: Modern Forensics at Treblinka

Comments on Caroline Sturdy Colls's Treblinka Research

By Thomas Kues

In November 2010, I published a blog entry on an online video concerning the research activity of a young British archaeologist from the University of Birmingham, Caroline Sturdy Colls, who had set out to refute “Holocaust Deniers” by locating the mass graves at the Treblinka “extermination camp” using “the most up-to-date scientific techniques.”⁹⁴⁵ Recently, a news report was published boldly stating that “mass graves at Nazi death camp Treblinka prove Holocaust deniers wrong.” In this we read:⁹⁴⁶

“A British forensic archaeologist has unearthed fresh evidence to prove the existence of mass graves at the Nazi death camp Treblinka. Some 800,000 Jews were killed at the site, in north east Poland, during the Second World War but a lack of physical evidence at the site has been exploited by Holocaust deniers. Forensic archaeologist Caroline Sturdy Colls has now undertaken the first co-ordinated scientific attempt to locate the graves.”

It is worth recalling that the same triumphant claim that the “Holocaust deniers” finally and once and for all had been “refuted” was heard in connection with Dr. Andrzej Kola’s surveys at Belzec and Sobibór, which in reality turned out to refute the official version of events relating to these two camps. (For this see the two books of the series “Holocaust Handbooks” on Belzec and Sobibor as advertised in the back of the book).

The above-quoted news item was more or less a push for a radio program, “Hidden Graves of the Holocaust” by Jonathan Charles featuring Sturdy Colls as well as Yitzhak Arad and former Treblinka inmate Kalman Taigman, which was broadcast by BBC Radio 4 on 23 January 2012, 20:00 GMT.⁹⁴⁷ In anticipation of this radio program, on the same date, a podcast interview was up-

⁹⁴⁵ Thomas Kues, “UK Forensic Archeologist Sets Out to Refute Treblinka ‘Deniers,’” 13. Nov. 2010, <http://revblog.codoh.com/2010/11/uk-forensic-archeologist-sets-out-to-refute-treblinka-deniers/>

⁹⁴⁶ “Mass Graves at Nazi Death Camp Treblinka Prove Holocaust Deniers Wrong,” *Huffington Post*, UK, 16 Jan. 2012; http://www.huffingtonpost.co.uk/2012/01/16/mass-graves-at-nazi-death-camp-treblinka-holocaust_n_1208814.html

⁹⁴⁷ This radio program was temporarily available at http://www.bbc.co.uk/iplayer/episode/b019rlns/The_Hidden_Graves_of_the_Holocaust/

loaded by the University of Birmingham “Ideas Lab.”⁹⁴⁸ In this we can listen to the following description of the methods employed by Sturdy Colls and her team, as well as some vague descriptions of their findings:

“Interviewer: What technology have you used to investigate the site?”

Sturdy Colls: I used a number of non-invasive techniques at Treblinka and what this means is, as you quite rightly pointed out, the ground wasn’t disturbed due to Jewish burial law so the methods used didn’t involve any form of ground disturbance or excavation and this allowed us to investigate the historic and scientific potential of Treblinka but obviously it was very important that we recognised its religious and commemorative significance as well. So the techniques that were used, there was a process of archival research which involved looking at documentary records, revisiting historical data if you like, looking at known data and assessing it with an archaeological eye, so looking for information about the landscape. Then there was a process of looking for aerial photographs of the site, any ground based photography, accounts by the witnesses, plans that had been created, etc., to build up a database of information so that when I did do the survey all of that could be corroborated against my results. So in the field this involved field walking, so assessing the landscape, topographic survey which used advanced GPS and total station surveying to demarcate features on a plan of the site allowed us to record micro-topographic change which may be indicative of buried features. And also to assess the visibility of other features such as a number of artefacts that were actually identified in quite a remote part of the site. Then moving on from that to look below the ground I used a number of geophysical techniques, so quite often mentioned is ground penetrating radar and this was one of the methods used but this was also corroborated with other methods that detect other physical properties in the soil. So I also used resistance survey and an extension of that which allows 3D imaging of buried remains as well, to ensure that all of the properties of the buried remains could be characterised accurately.

Interviewer: And what have you discovered?”

Sturdy Colls: Well the survey results when corroborated with historical information have indicated that there are a number of surviving building foundations at Treblinka just below the surface and also a considerable amount of obviously structural debris which the Nazis would have been simply unable to have removed from the site, and this supports accounts written by post-war investigators which commented upon the visibility of

⁹⁴⁸ http://www.ideaslab.bham.ac.uk/MP3s/Caroline_Sturdy_Colls_Treblinka_podcast.mp3. A transcript of this podcast could once be found at http://www.ideaslab.bham.ac.uk/MP3s/Transcript_Predictor_Podcast_40.doc; now archived at <https://archive.org/web/>.

artefactual remains, structural remains, at the camp. We've also identified a number of pits at the site. Again, all these pits have been mapped and corroborated with witness plans and this is indicative of a number of probable graves at the site. It is recognised as part of the survey that the history of Treblinka didn't end with its abandonment by the Nazis. Issues such as post-war looting and the construction of the memorial itself and a number of other forms of landscape change that have taken place at the site, you know, could confuse interpretation so it was essential that all of these were considered when the results from the geophysical survey in particular were being assessed. So then all of this data was married up with historical information so we seem to have a situation here where it's been commonly believed that all of the victims at Treblinka were cremated, they were destroyed without trace, however, the research has revealed a much more complex picture of the disposal patterns used by the Nazis. Looking at it from an offender profiling perspective, so a slightly more forensic point of view, the Nazis worked on, as do most offenders, this principle of least effort where they would actually have a burial method that very much matched the nature of their victims or their locations within the camp and there are a number of photographs and physical evidence that we observed on the ground at Treblinka that demonstrates that these bodies were not reduced to ash, that some survive as mass graves in the truest sense and that also the ashes of the victims were redeposited into the pits that they were originally exhumed from upon Himmler's order in 1943. Also with the topographic survey we've demonstrated that the camp as it's marked currently on the ground by the modern memorial was actually much larger, that the boundaries of the camp should have been 50 metres further north and this has a knock-on effect for a number of structures within the camp itself. So we can examine it from a spatial point of view and look at all of these features in relation to each other and hopefully eventually start to build up a more detailed map of the camp as it existed during its operation.

Interviewer: So you've now presented your findings to the authorities responsible for the memorial at Treblinka. Does this conclude investigations at the Treblinka site or is it sort of an ongoing project?

Sturdy Colls: It's absolutely an ongoing project. The survey demonstrated that the site has got huge potential in terms of what we can learn from the application of archaeological method and very much was the tip of the iceberg in terms of being the first survey of what I hope will be many more to come. I hope to return to the site later on this year and there will be subsequent seasons of fieldwork in coming years. As I mentioned, at the moment what we've got is a map of what survived at the camp as a result of my findings. However, in order to build up a map of the camp as it existed we need to do more work, we need to survey the site. Only a small proportion

of the site has actually been surveyed so there's huge potential to find out more about the history of this camp in the future."

Somewhat more on the findings of Sturdy Colls could be gleaned from the BBC 4 radio documentary "Hidden Graves of the Holocaust." Starting at the mark 23:20 minutes we hear:

"Caroline Sturdy Colls: All the history books states that Treblinka was destroyed by the Nazis, in summary, the survey demonstrated that this simply isn't the case. I have identified a number of buried [sic] pits using geophysical techniques. These are considerable. One in particular is 26 meters by 17 meters.

Jonathan Charles: That's huge.

Sturdy Colls: It is huge. We are talking about a considerable number of bodies [which] could have been contained within pits of that size.

Charles: That could have contained hundreds, perhaps thousands of bodies, we don't know how deep it is, or do you know how deep it is?

Sturdy Colls: Unfortunately no. The survey technology does not allow us to go to certain depths. I know that it is over 4 meters, that was the extent of this [inaudible]. It's a considerable pit.

Charles: There are quite a few pits that you have discovered?

Sturdy Colls: Absolutely, there were a number of pits, in particular to the rear of what of what is now the current memorial, five that are actually in a row, again of a considerable size, in an area where witnesses state this was the main body disposal area, this is behind the gas chambers, it was where the majority of victims who were sent there were then subsequently buried, and later where the cremative remains of the victims were also placed.

Charles: It's not just pits that you found, there's also what look like buildings.

Sturdy Colls: There are, and again, the Nazis claimed they destroyed Treblinka, they certainly levelled the site, but it's not really possible when buildings have been on a site to actually sterilize the ground, so what I've identified is that solid structural remains, we're talking building foundations, do survive, but in particular two sort of structures that I've identified are likely to be the old and new gas chambers at Treblinka."

While here we learn virtually nothing about the supposed remains of the Treblinka "gas chambers," we are provided with some tantalizing information on the camp's burial pits. Needless to say, a critical assessment of the findings made by Sturdy Colls can only be made after she has published at least a preliminary report or a detailed article on the same, but we may nonetheless with appropriate caution note down some preliminary observations on what has been revealed so far. The most-interesting information, however, is not to be found in the radio interviews, but in a short article by Sturdy Colls herself

which was published on the website of the BBC on 23 January.⁹⁴⁹ In this we read:

“The existence of mass graves was known about from witness testimony, but the failure to provide persuasive physical evidence led some to question whether it could really be true that hundreds of thousands of Jews were killed here.

Although they lasted only a few days, those post-war investigations [in 1945-1946] remained the most complete studies of the camp until I began my work at Treblinka in 2010.

This revealed the existence of a number of pits across the site.

Some may be the result of post-war looting, prompted by myths of buried Jewish gold, but several larger pits were recorded in areas suggested by witnesses as the locations of mass graves and cremation sites.

One is 26m long, 17m wide and at least four metres deep, with a ramp at the west end and a vertical edge to the east.

Another five pits of varying sizes and also at least this deep are located nearby. Given their size and location, there is a strong case for arguing that they represent burial areas. [...]

As well as the pits, the survey has located features that appear to be structural, and two of these are likely to be the remains of the gas chambers.

According to witnesses, these were the only structures in the death camp made of brick.”

Even more important is the fact that this article is illustrated with two composite maps on which the outlines of the findings made by Sturdy Colls have been superimposed on a modern-day aerial photograph of the former camp site and on a 1944 aerial photograph of the same area. In the figure to the right I have placed these two composite maps side by side, moved the main legend and the scale, and slightly increased the picture size in order to allow for easier comparison of scale. On the map to the left I have also arbitrarily numbered the “probable burial/cremation pits” from 1 to 10. (Click on the picture to view it in full size).

The information furnished by the two interviews, the article and the maps allow us to make the following observations:

1. The pit which Sturdy Colls mentions “in particular” and which is stated to have a surface area of “26 meters by 17 meters,” that is a total of 442 square meters, is, judging by the dimensions, most likely identical with the rather irregular Pit #3, located some 25 m south of the large cenotaph. This is clearly the largest in surface area of the 10 pits identified.
2. As far as the surface area is concerned, two of the 33 mass graves identified by Andrzej Kola at Belzec (pits #1 and 27) were larger (with 480 and

⁹⁴⁹ “Treblinka: Revealing the Hidden Graves of the Holocaust,” *BBC Magazine*, 23 Jan. 2012; www.bbc.co.uk/news/magazine-16657363

540 square meters respectively), whereas two more (#7 and 14) were almost of the same size (364.5 and 370 square meters respectively).⁹⁵⁰ Of the six burial pits identified by Kola at Sobibór, two (Pits #2 and 4) were larger or even significantly larger (with surface areas of 500 and 1,575 square meters respectively), whereas two other graves were nearly of the same surface size (Pits #1 and 6, with 400 and 375 square meters respectively).⁹⁵¹ Yet whereas at Belzec some 435,000 and at Sobibór some 80,000 corpses are alleged to have been interred,⁹⁵² the number of uncremated bodies buried at Treblinka is supposed to have amounted to at least some 700,000. Would it then not make sense for the Germans to use mass graves of a larger size at Treblinka than at the other two Reinhardt camps?

3. The eyewitnesses Eliahu Rosenberg and Chil Rajchman, who to the knowledge of this author are the only witnesses to have provided detailed statements on the dimensions of the mass graves in the “death camp proper,” claim pits of sizes vastly larger than the largest pit mapped by Sturdy Colls. Eliahu Rosenberg claimed in 1947 that the mass graves measured 120 m × 15 m × 6 m, giving a surface area of 1,800 square meters and a total volume of 9,900 cubic meters.⁹⁵³ Chil Rajchman, whose 1944 testimony⁹⁵⁴ is prominently featured in the “Hidden Graves of the Holocaust” radio program – including a particularly bizarre passage from it concerning burning blood – states:⁹⁵⁵

“The pits were enormous, about 50 metres long, about 30 wide and several storeys deep. I estimate that the pits could contain about four storeys.”

The burial pits thus measured 1,500 square meters according to the witness Rajchman and maybe as much as (1,500 × 12 =) 18,000 cubic meters in volume! How come that the largest of the pits discovered by Sturdy Colls corresponds to less than one third of the surface size claimed by Rajchman and to one fourth of the surface area claimed by Rosenberg?

4. It is indeed unfortunate that the top modern equipment used by Sturdy Colls for some reason or other was not able to detect depths exceeding 4 meters. Perhaps it would have been wise of her to dispense of some of the piety with regards to “Jewish burial laws” and utilize probe drillings to

⁹⁵⁰ Cf. Carlo Mattogno, *Belzec: Propaganda, Testimonies, Archeological Research, and History*, Theses & Dissertations Press, Chicago 2004, p. 73.

⁹⁵¹ Cf. Jürgen Graf, Thomas Kues, Carlo Mattogno, *Sobibór: Holocaust Propaganda and Reality*, 2nd ed., Castle Hill Publishers, Uckfield 2020, p. 128.

⁹⁵² Cf. *ibid.*, p. 125.

⁹⁵³ Cf. Jürgen Graf, Carlo Mattogno, *Treblinka*, the present book, p. 138.

⁹⁵⁴ Discussed in detail in my article “Chil Rajchman’s Treblinka Memoirs,” *Inconvenient History*, Vol. 2, No. 1, 2010; www.inconvenienthistory.com/2/1/1916

⁹⁵⁵ Chil Rajchman, *Treblinka. A Survivor’s Memory 1942–1943*, MacLehose Press, London 2011, p. 60.

measure the depths of the pits, as was done by Kola at both Belzec and Sobibór. Of the pits identified by Kola in these two camps, the deepest pit (#3 at Sobibór) measured 5.80 m, whereas the depths of the remaining pits averaged some 4 m.

Generously assuming Rosenberg's estimate of 6 meters (Rajchman's estimate of some 12 meters can be safely dismissed as an exaggeration), and even more generously assuming (for the sake of argument) 6 meters to be the effective depth, with the pit walls being vertical instead of sloping (an obviously unrealistic assumption, which is moreover contradicted by Sturdy Colls's statement that this pit had a "ramp" at the west end and a "vertical edge to the east," implying that three out of four side walls were oblique – but again, for the sake of argument...) Pit #3 would have a volume of $(26 \times 17 \times 6 =) 2,652$ cubic meters. Assuming an average capacity of 8 corpses per cubic meter,⁹⁵⁶ this means that the pit in question could have contained in total $(2,652 \times 8 =) 21,216$ corpses. Since the so-called Höfle document *from an exterminationist viewpoint* shows that nearly 713,555 were murdered at Treblinka up until the end of 1942 – in reality this document only proves that this number of Jews was *deported* to the camp up until that time – and since virtually all sources maintain that non-experimental cremations on a significant scale did not commence at Treblinka until 1943, at least 700,000 corpses would have to have been interred in the camp, necessitating no less than $(700,000/21,216 =) 33$ pits of the same size as Pit #3, with a total surface area of 14,586 square meters, or nearly 1.5 hectares. Needless to say, the mass graves would have had to be separated by soil walls of considerable thickness, thereby increasing the surface area required by the graves.

5. Pits #1 and 2, which together appear to have a surface area of some 600-700 square meters, are located in the western part of the camp site, near the torn-up railroad siding, clearly outside of the "death camp proper." These may be identical with the mass graves mentioned by the witness Abraham Kszepicki, in which the bodies of Jews who had died *en route* to the camp were buried during the first months of operation.⁹⁵⁷
6. The four Pits #5-8 are placed in a (not-very-straight) row. Sturdy Colls states in the radio documentary that there are "five" pits of "considerable size" "in a row" and in the area which witnesses state "was the main body-disposal area, [...] behind the gas chambers." Either Sturdy Colls mistakenly said five when she meant four, or maybe she counted one of the other pits, perhaps Pit #6, with its "neck" in the middle, as two separate pits. Re-

⁹⁵⁶ Cf. Carlo Mattogno, "Belzec or the Holocaust Controversy of Roberto Muehlenkamp," Section 4.1., Jan. 2009, <https://codoh.com/library/document/975/>

⁹⁵⁷ Yitzhak Arad, *Belzec, Sobibor, Treblinka: The Operation Reinhard Death Camps*, Indiana University Press, Bloomington and Indianapolis 1987, p. 85.

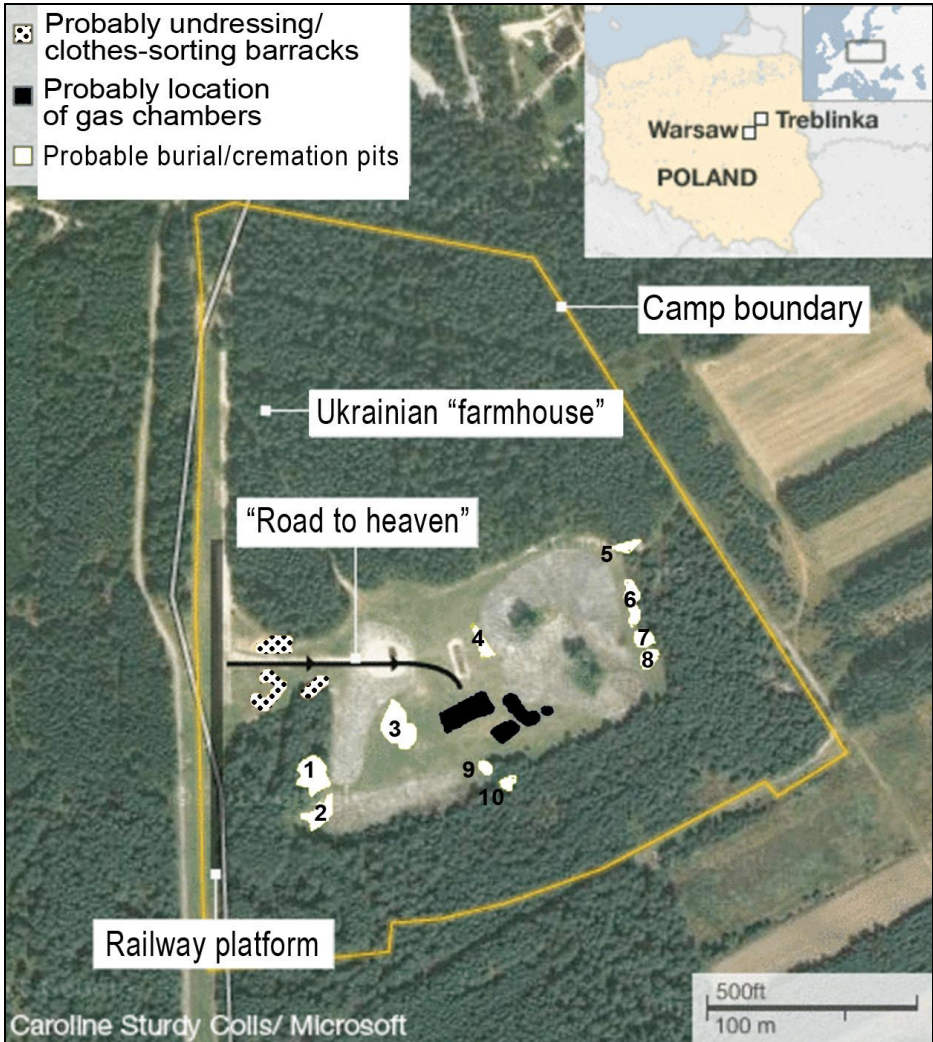

Overlay of air photos by Caroline Sturdy Colls (top) and by the German air force of November 1944 (next page) with the objects found by C. Sturdy Colls.

Regardless of which, it is clear that the Pits #5-8 cover a surface area which corresponds to roughly 175-200% that of #3, that is, somewhere in the range of 750-900 square meters.

7. Altogether, Pits #3-10 as mapped by Sturdy Colls cover a surface hardly exceeding 1,800 square meters. If we assume, again for the sake of argument, the no-doubt-overly generous average effective depth of 6 meters with vertical pit walls – and once more I want to remind my readers that the pits identified at Belzec and Sobibór averaged some 4 m in depth – this



would mean that the “probable burial/cremation pits” in the “death camp proper”/”upper camp”/”camp 2”⁹⁵⁸ had a total volume of some $(1,800 \times 6 =) 10,800$ cubic meters.

The pits at Belzec as identified by Kola have a total estimated volume of 21,310 cubic meters,⁹⁵⁹ whereas those at Sobibór have a total estimated volume of 14,718 cubic meters.⁹⁵¹ The no-doubt-greatly exaggerated esti-

⁹⁵⁸ Judging by some of the early maps of the camp, Pit #3 would have been located outside of this part of the camp, whereas some later exterminationist efforts to reconstruct the topography of the camp place it within the “death camp proper,” cf. *Mapping Treblinka*, <http://www.deathcamps.org/treblinka/maps.html>

⁹⁵⁹ C. Mattogno, *Belzec...*, *op. cit.*, p. 73.

mate of 10,800 cubic meters could have contained at most some (10,800 × 8 =) 86,400 corpses (assuming instead a more-realistic average effective depth of 5 m this figure would change to 72,000 – and this still disregards the likely enlargement of the original grave volumes due to clandestine diggings and other causes). According to Yitzhak Arad, some 312,500 Jews were murdered in Treblinka merely “during the first five weeks of the killing operation.”⁹⁶⁰ According to the files of the Jewish Council in Warsaw, 251,545 Jews from the ghetto in that city were deported to Treblinka between 22 July 1942 and 12 September 1942.⁹⁶¹ And as already mentioned, the Höfle document states that 713,555 were deported to Treblinka up until the end of 1942. Judging by the information revealed, only a small fraction of this enormous number of people could have been buried in the identified “probable burial/cremation pits,” even taking into account the two pits in the reception camp, which, given the reported structure of the camp, could not have been used for any hypothetical “gas-chamber” victims.

8. Sturdy Colls’s statement that “the failure to provide persuasive physical evidence [of mass graves] led some to question whether it could really be true that hundreds of thousands of Jews were killed here” implies that the presence of mass graves itself would be enough to refute the “deniers.” However, it is clear that mass graves of considerable size must have existed at Treblinka, even if it was in fact only a transit camp. Holocaust historian Dieter Pohl estimates that up to 5 % of the deportees to the Reinhardt camps perished *en route* due to suffocation, dehydration, crushing caused by panicking deportees etc.⁹⁶² Considering that the reception of transports at Treblinka during the intense initial months of operation is claimed to have been grossly mismanaged by the first camp commandant, Dr. Irmfried Eberl (who, apparently because of this reason, was fired and replaced by Franz Stangl), which led to the delay of transports at way stations⁹⁶³ – and this in the summer heat of July and August – there is little reason to doubt this estimate with regard to Treblinka. Since some 800,000 Jews in total were deported to Treblinka during the camp’s period of operation (July 1942 – August 1943), this would mean a total of some 40,000 *en route* deaths. Moreover, there are reasons to assume that a smaller percentage of the deportees were subjected to “euthanasia” due to contagious or mental diseases, or for being too weak for further transport. To this should be add-

⁹⁶⁰ Y. Arad, *Belzec, Sobibor, Treblinka*, *op. cit.*, p. 87.

⁹⁶¹ *Ibid.*, pp. 275f.

⁹⁶² Dieter Pohl, “Massentötungen durch Giftgas im Rahmen der ‘Aktion Reinhardt’: Aufgaben der Forschung” in: Günter Morsch, Bertrand Perz (eds.), *Neue Studien zu nationalsozialistischen Massentötungen durch Giftgas: Historische Bedeutung, technische Entwicklung, revisionistische Leugnung*, Metropol, Berlin 2011, p. 194.

⁹⁶³ Cf. Y. Arad, *Belzec, Sobibor, Treblinka*, *op. cit.*, pp. 87f.

ed a smaller number of deaths among the camp inmates caused by epidemics etc., as well as those killed by guards in connection with attempts at escape or uprisings.

9. The vague mention of a “more complex picture of the disposal patterns used by the Nazis” is interesting. Were uncremated corpses also detected by the survey, and if so, how many?
10. Sturdy Colls labeled the pits “probable burial/cremation pits,” indicating that one or more of the pits may have been used for cremations and not for interment (at Sobibór Kola identified such a pit with an area of 10×3 m and a depth of up to 90 cm). In this context the smaller, more-rectangular Pits #4 and 5 may be the most likely candidates. The dimensions of an identified cremation pit could give important hints about the actual cremation capacity at Treblinka.
11. It is noteworthy that none of the pits or structural remains are located under the stone/concrete covered memorial areas (cf. the map to the left, where these areas are visible as a bluish gray). Sturdy Colls did not mention whether or not she was able to map these area with her geophysics equipment.⁹⁶⁴ This issue, like many others, will have to await further clarification. The covered area inside the “death camp proper” appears to correspond to roughly 1 hectare.
12. It may be worth making a quick comparison of the maps furnished by Sturdy Colls with the “reconstruction” of Treblinka proposed by exterminationist air-photo analyst Alex Bay.⁹⁶⁵ Concerning the mass graves Bay writes:⁹⁶⁶

“Unfortunately, the aerial photography does not contain enough information to delineate the boundaries of the graves. The May [1944] coverage is sufficient only for crudely identifying the places where deep disturbances in general are probable, but the exact boundaries cannot be established.

In Figure 42 aerial photography is presented in which nine 50 by 25 meter [164 × 82 feet] pits have been drawn to scale along the east and west sides. The positioning and size of these pits is purely speculative.”

⁹⁶⁴ According to the English-language Wikipedia article on Ground Penetrating Radar (http://en.wikipedia.org/wiki/Ground-penetrating_radar) “Dry sandy soils or massive dry materials such as granite, limestone, and concrete tend to be resistive rather than conductive, and the depth of penetration could be up to 15 metres (49 ft),” implying that the concrete slabs of the memorial in themselves should pose little problem for a GPR survey. There may of course be other, unrevealed occluding factors.

⁹⁶⁵ *The Reconstruction of Treblinka*,

<https://web.archive.org/web/20110702170758/http://www.holocaust-history.org/Treblinka/>

⁹⁶⁶ <https://web.archive.org/web/20110717054059/http://www.holocaust-history.org/Treblinka/deathcampinternet/deathcamp7.shtml>

The dimensions of 50 × 25 m for the pits are taken from Bay's Number One eyewitness, Jankiel Wiernik, and his 1944 publication *A Year in Treblinka*. Wiernik writes indeed that "The dimensions of each ditch were 50 by 25 by 10 meters"⁹⁶⁷ but this almost certainly refers to ditches located not in the "death camp proper," but in the reception camp. The scene wherein Wiernik provides the above-mentioned dimensions takes place on the second day after his arrival in the camp, and the following chapters imply that he first visited the "death camp proper" or Camp II, as he calls it, only several days later.

In the figure to the right I have placed Bay's Figure 42 side-by-side with the Sturdy Colls composite map based on the 1944 air photo. (Click on it to open a full-size version.) The scales of the two maps have been harmonized. To Bay's map I have also added the letters A and B to indicate the solid-black outlines drawn by Bay to mark out the two alleged gas-chamber buildings. Even considering Bay's admission that the positioning and size of his mass graves "is purely speculative," it is clear that his vision of what the "death camp proper" might have looked like differs considerably from Sturdy Colls' map. As for the locations of the two alleged gas chamber buildings, which Bay goes to painstaking length to identify (based on the aerial photos and witness statements), the four structures marked out by Sturdy Colls (in blue) and designated "probable location of gas chambers" are located some 100 m south of the sites pinpointed by Bay. The alignment of these structures is also rather different from that asserted by Bay. Together with the considerable difference in surface size between the mass graves posited by Bay and the pits identified by Sturdy Colls, this says something of the competence of Bay as well as the reliability of his star witness Wiernik.

13. As for the "probable location of gas chambers" we learn virtually nothing other than that Sturdy Colls has identified two brick structures. On the composite maps, however, four structures are marked out, of which the largest (near the eastern exit of the "Road to heaven") is likely to be the one identified by Sturdy Colls as the "new gas-chamber building." The three other structures, two of which are relatively large, are located close to each other. One must suppose that one of the two larger structures has been identified by Sturdy Colls as the "old gas-chamber building." According to the most elaborate exterminationist effort to map Treblinka based on aerial photos and eyewitness testimony – the 2004 map by Peter Laponder (who also refers to ground photos taken inside the "death camp proper" as found in Kurt Franz's photo album "Schöne Zeiten")⁹⁶⁸ – the only structures lo-

⁹⁶⁷ Y. Wiernik, *A Year in Treblinka*, Chapter 3, online:
<http://www.zchor.org/treblink/wiernik.htm>

⁹⁶⁸ <http://www.deathcamps.org/treblinka/pic/bmap9.jpg>

cated adjacent to the “old gas chamber building” were a water-pump shelter, a tiny guardhouse, and a watchtower. Yet on the composite map we have two larger structures next to each other. We will have to wait and see if the geophysical survey has revealed anything about the layout of these structures. If that is not the case, we can only hope that Sturdy Colls soon returns to the camp site to excavate the detected structural remains.

All in all, the information revealed by these interviews about the findings of the 2011 geophysical survey at Treblinka provides us with more questions than answers. We can only wait and hope that a preliminary report on the research results is not too long in coming. One thing is sure, however, namely that little indicates that the findings of Caroline Sturdy Colls have actually “proven Holocaust deniers wrong” with regard to Treblinka. On the contrary: the information revealed seems to hint that the findings of Caroline Sturdy Colls may well spell doom for the official historiography on Treblinka.

Editor’s Addendum

As I write these remarks in early 2020, it looks like Dr. Sturdy Colls still hasn’t published any more specific details about her forensic investigations on the grounds of the former Treblinka Camp. In her published PhD thesis she cites herself as “Sturdy Colls, C. (2014b). *Finding Treblinka: Archaeological Evaluation*. Unpublished Fieldwork Report. Stoke on Trent: Centre of Archaeology, Staffordshire University.”⁹⁶⁹ It would be nice if she cleaned up that report and published it, but that’s probably never going to happen.

Her website cites a 2015 work with the title *Finding Treblinka: An Exhibition of Forensic Archaeological Research* as a mere exhibition catalogue, which contains no further details either.⁹⁷⁰ A chapter she says she contributed to an anthology on modern-day genocides is eternally “in press” and hasn’t appeared to this day.⁹⁷¹

In other papers, she at best refers to her PhD thesis, which does not go into any specifics of her Treblinka research:

- Caroline Sturdy Colls, “Gone but not Forgotten: Archaeological approaches to the site of the former Treblinka Extermination Camp in Poland,” *Holocaust Studies and Materials* (English edition), 3 (2013), pp. 253-289. This paper refers the reader to her PhD thesis.
- Caroline Sturdy Colls, “Une cartographie de la terreur nazie: études archéologiques dans les camps de travail et d’extermination de Treblinka,”

⁹⁶⁹ Caroline Sturdy Colls, *Holocaust Archaeologies: Approaches and Future Directions*, Springer, Cham, 2015, pp. 51, 83.

⁹⁷⁰ <https://www.staffs.ac.uk/people/caroline-sturdy-colls#publications>

⁹⁷¹ On her website quoted as “Sturdy Colls, C. 2018 (In Press). Unearthing Treblinka?: Archaeological Investigations at Treblinka Extermination and Labour Camps. In: Vareka, P. and Symonds, J. *Dark Modernities*. Basingstoke: Palgrave Macmillan.”

- in: Jean Guilaine, Jacques Sémelin (eds.), *Violences de guerre, violences de masse*, La Découverte, Paris 2016, pp. 261-274. This one refers to her PhD thesis and the previous paper.
- Dante Abate, Caroline Sturdy-Colls, “A multi-level and multi-sensor documentation approach of the Treblinka extermination and labor camps,” *Journal of Cultural Heritage*, Vol. 34 (2018), pp. 129-135. This paper is almost exclusively dedicated to forensic methods without revealing any results. In just one sentence, she claims that locating “the camp boundaries, mass graves, and gas chambers [...] were successfully achieved” (p. 130), but she gives no proof for it.
 - Caroline Sturdy Colls, Michael Branthwaite, “‘This is Proof’? Forensic Evidence and Ambiguous Material Culture at Treblinka Extermination Camp.” *International Journal of Historical Archaeology*, 22(2) (2018), pp. 430-453. In this paper she reports how she found some tiles and building material next to a lot of personal items (such as jewelry, hair clips, coins) in a small pit of 1 m × 1 m she excavated, claiming that this “confirmed the location of the old gas chamber...” (p. 441, also p. 434). Again, no proof for this is given at all. Quite to the contrary, she has to admit that finding personal belongings near what she thinks was a gas chamber, and finding traces of unburnt human remains “appears to challenge the accepted history of the site”, because all victims are said to have had to get undressed long before getting anywhere near the gas chambers, and all victims are said to have been cremated more or less “without a trace”.

Once more, orthodox historiography on the Holocaust faces a crippling disaster. Realizing this, Sturdy Colls beats around the bush by saying that her research results allow for “many truths” regarding Treblinka: “multiple interpretations and ‘many truths’ can be a more appropriate approach” to understand her ambiguous results (p. 448). Does she seriously mean to say that both the orthodox and the revisionist narrative are true? She admits that the many inconsistencies within the orthodox narrative and between this narrative and her results “may provide further opportunities for those who seek to deny the Holocaust,” which is the last thing she wants to happen. Since admitting defeat is no option for her, she offers her meagre results as something that “should be viewed as providing insight into conflicting historical narratives” offering “various lineages.” If you have trouble understanding this academic pseudo-intellectual gibberish, that’s because it makes no sense. She is simply trying to hide that she came back empty-handed. No proof of real gas chambers, no proof of the needed mass graves, no proof of the required piles of ash, teeth, bone fragments, nothing. And yet, this young forensic archaeologist is trying to salvage a piggy-back ride on the crumbling Holocaust narrative in order to give her career a jump-start. That’s all there is to it.

Appendices

Documents

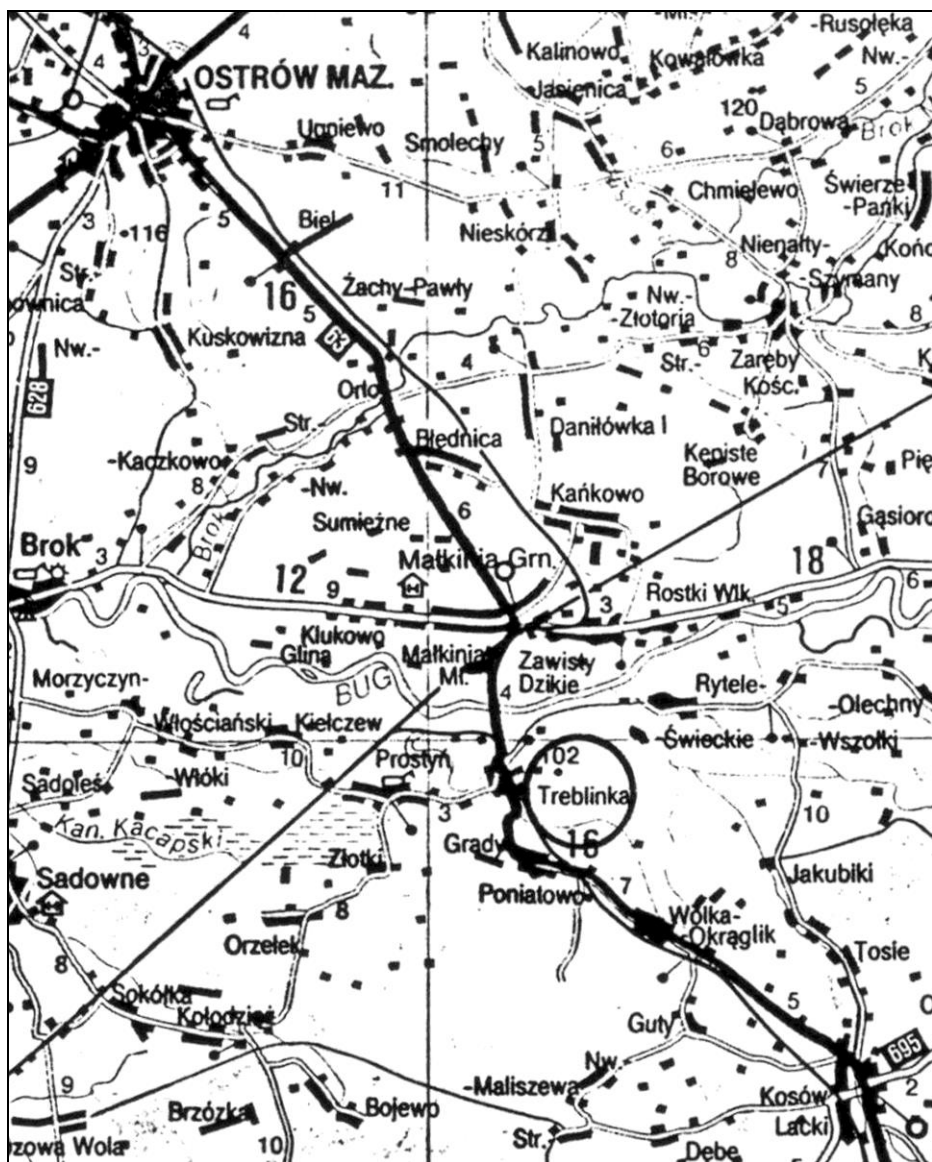

Document 1: Geographic location of Treblinka. From: *Atlas samochodowy Polski, Warsaw-Breslau 1997.*

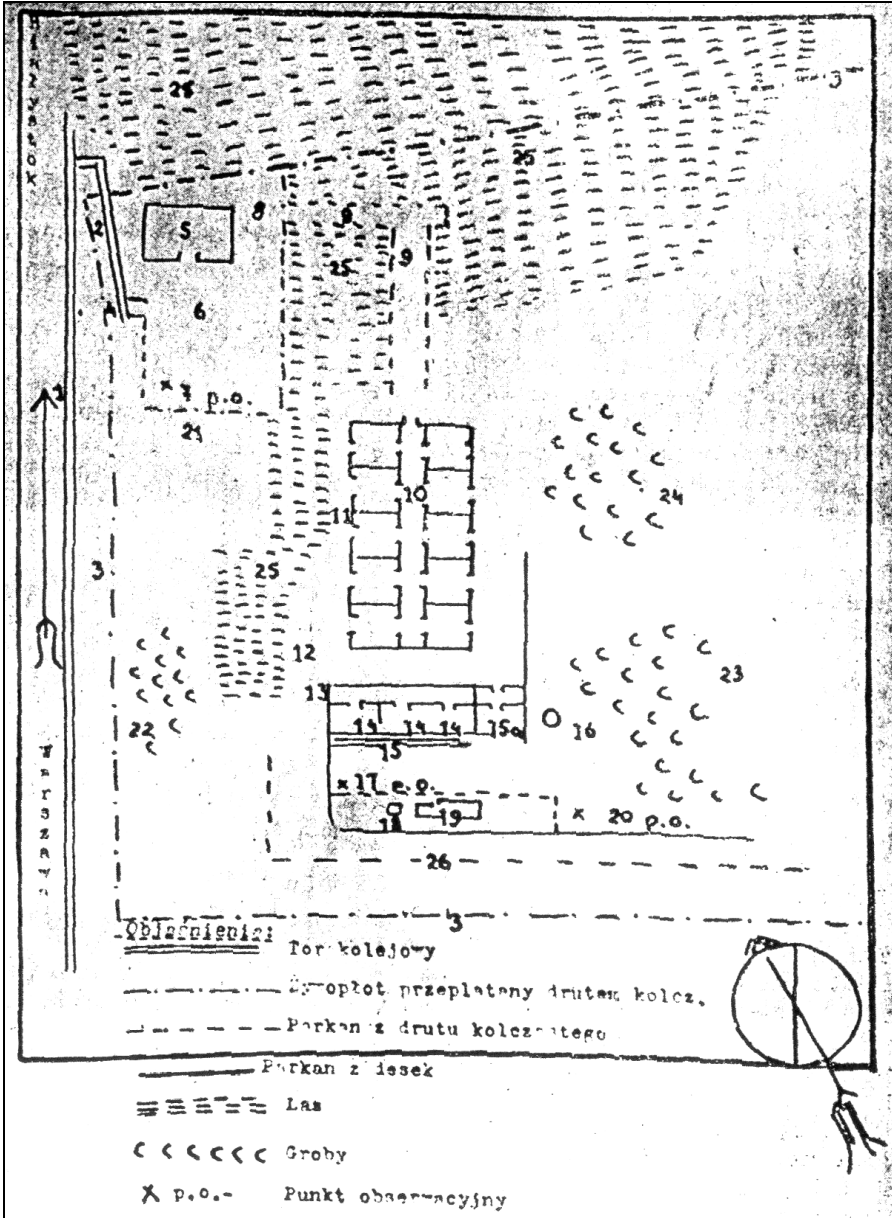

Document 2: Plan of Treblinka, enclosed with the Report of November 15, 1942. From: Krystyna Marczevska and Władysław Ważniewski, "Treblinka w świetle akt Delegatury Rządu RP na Kraj" (Treblinka in Light of the Documents of the Home Government Delegation, i.e., the leadership of the Polish underground of the Polish Republic), in: *Biuletyn Głównej Komisji Badania Zbrodni Hitlerowskich w Polsce*, Volume XIX, Warsaw 1968, p. 141.

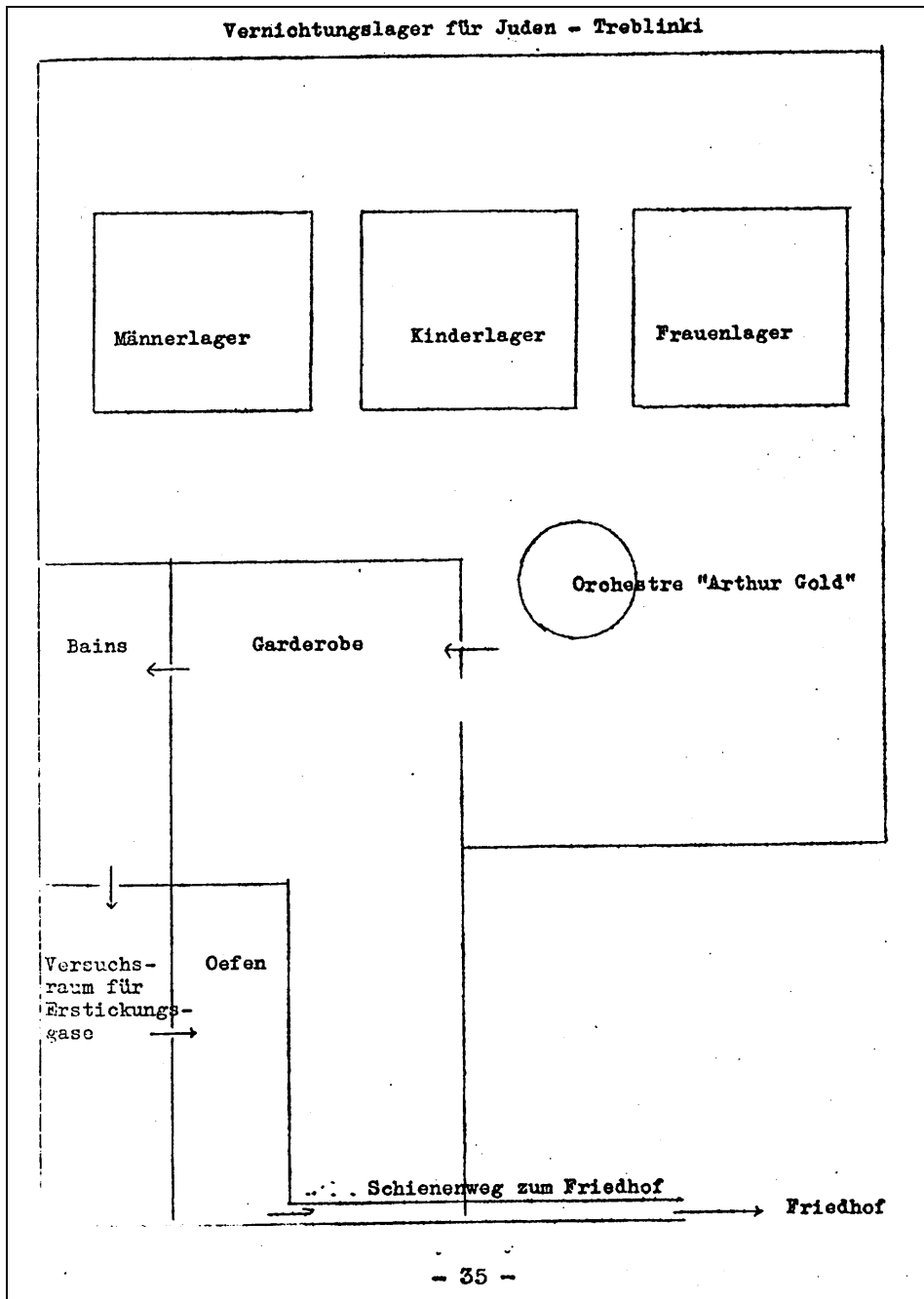

Document 3: Plan of Treblinka, enclosed with the report published by A. Silberschein. From: A. Silberschein, *Die Judenausrottung in Polen*, Geneva 1944, third series, p. 35.

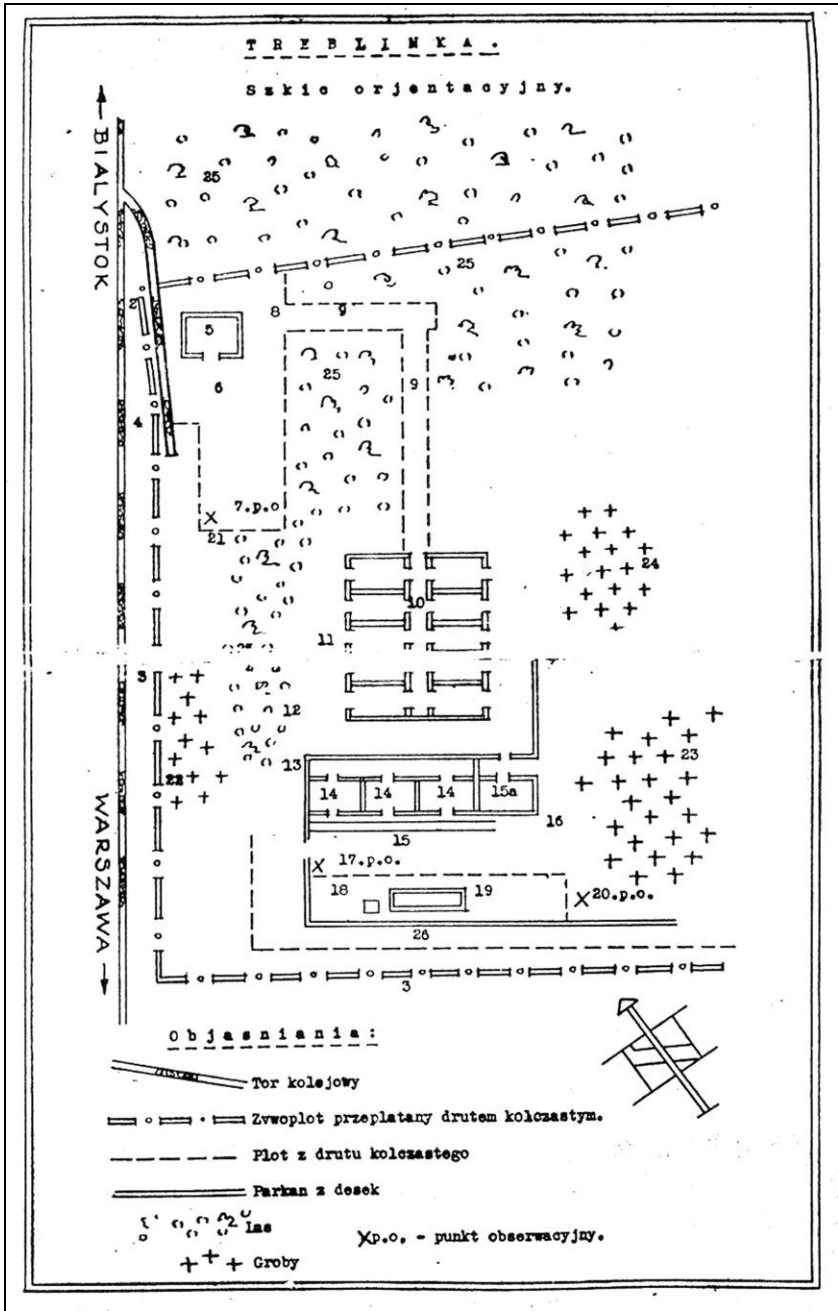

Document 4: Plan of Treblinka, published by J. Wiernik in 1944.
 From: Yankel (sic) Wiernik, A Year in Treblinka, published by
 American Representation of the General Jewish Workers' Union of
 Poland, New York 1944, pp. 24f.

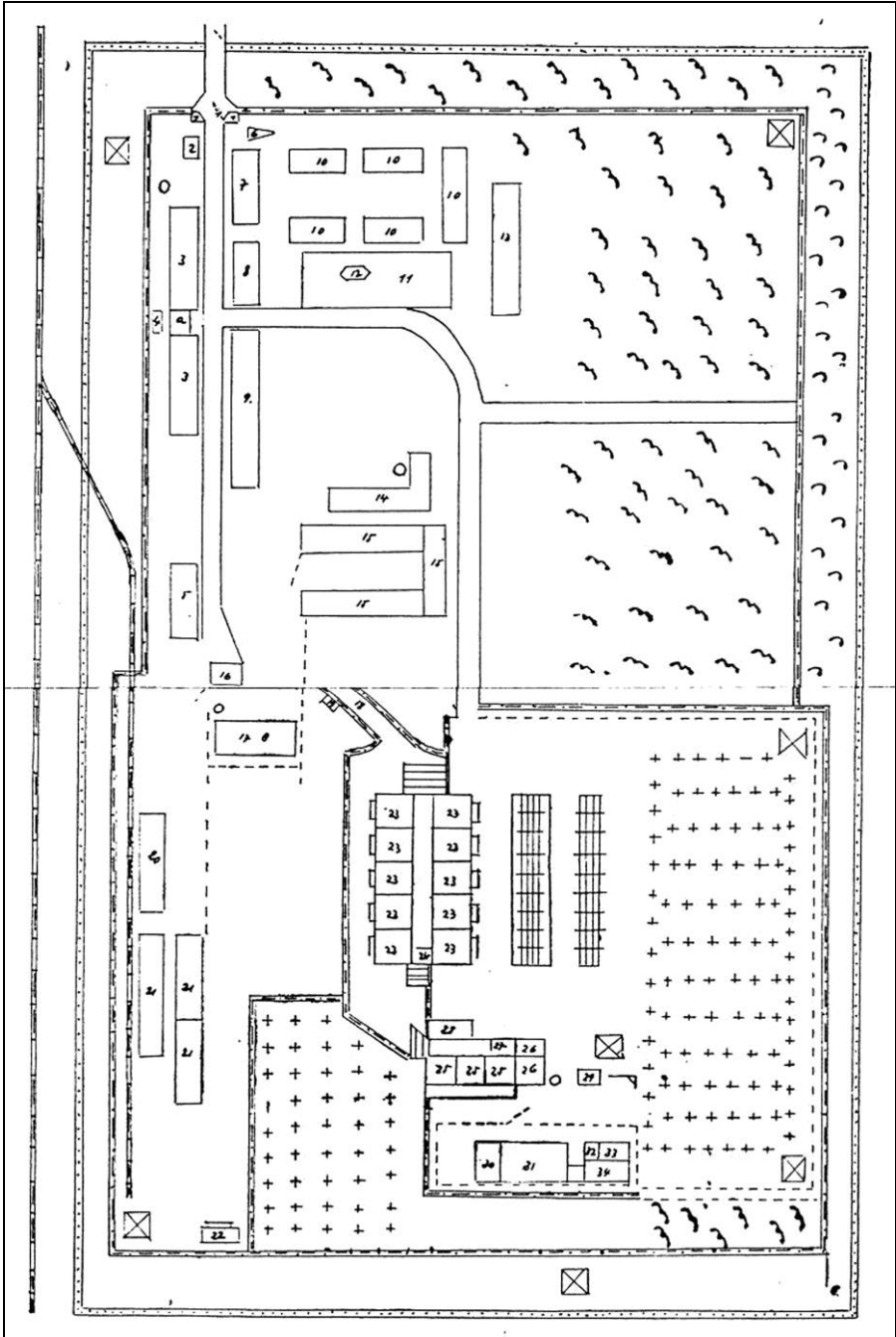

Document 5: Plan of Treblinka, drawn in 1945 by J. Wiernik. From: Filip Friedman, *This Was Oświęcim!*, The United Jewish Relief Appeal, London 1946, pp. 81-84.

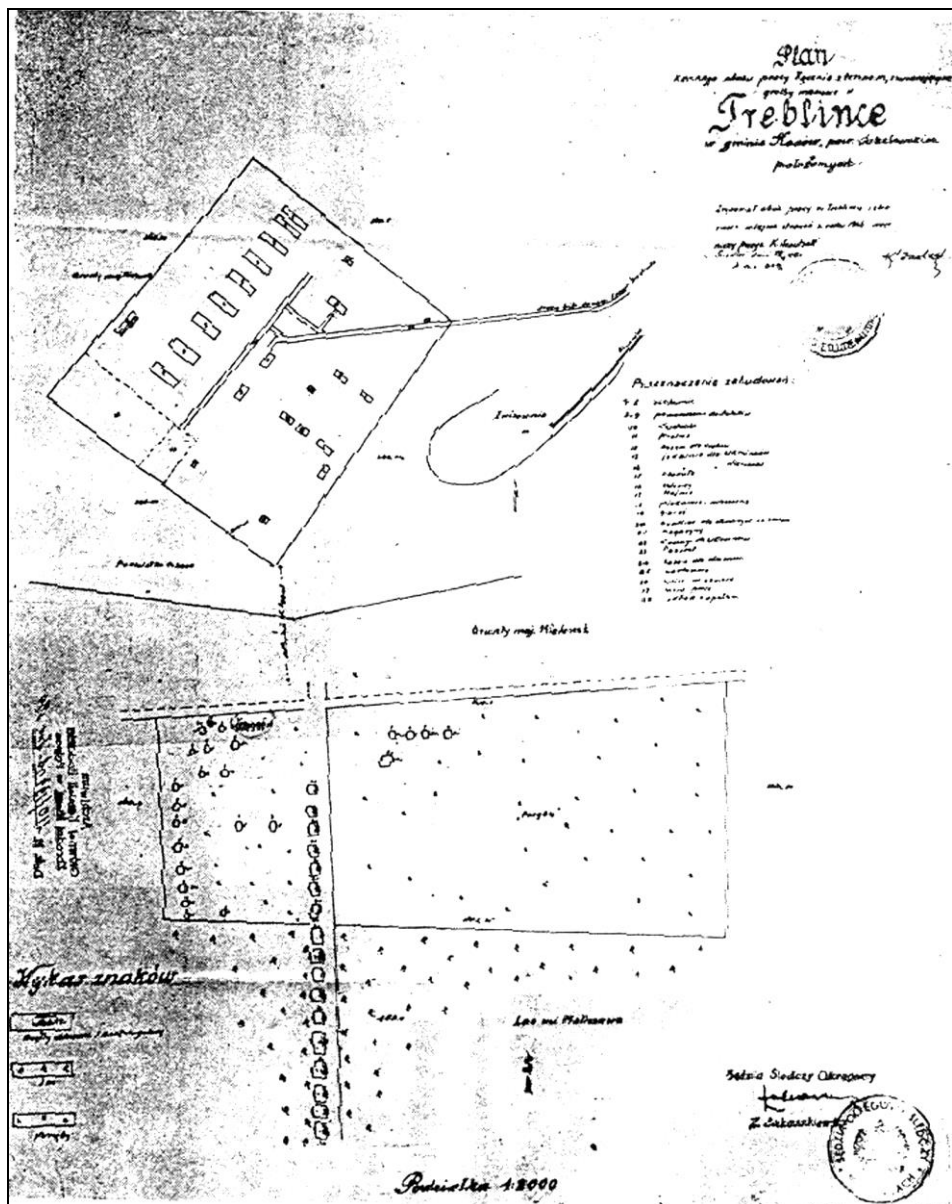

Document 6: Plan of Treblinka, drawn by the surveyor K. Trautsołt. From: Stanisław Wojtczak, "Karny obóz pracy Treblinka I i ośrodek zagłady Treblinka II," in: *Biuletyn Głównej Komisji Badania Zbrodni Hitlerowskich w Polsce*, Warsaw 1975, XXVI, p. 158.

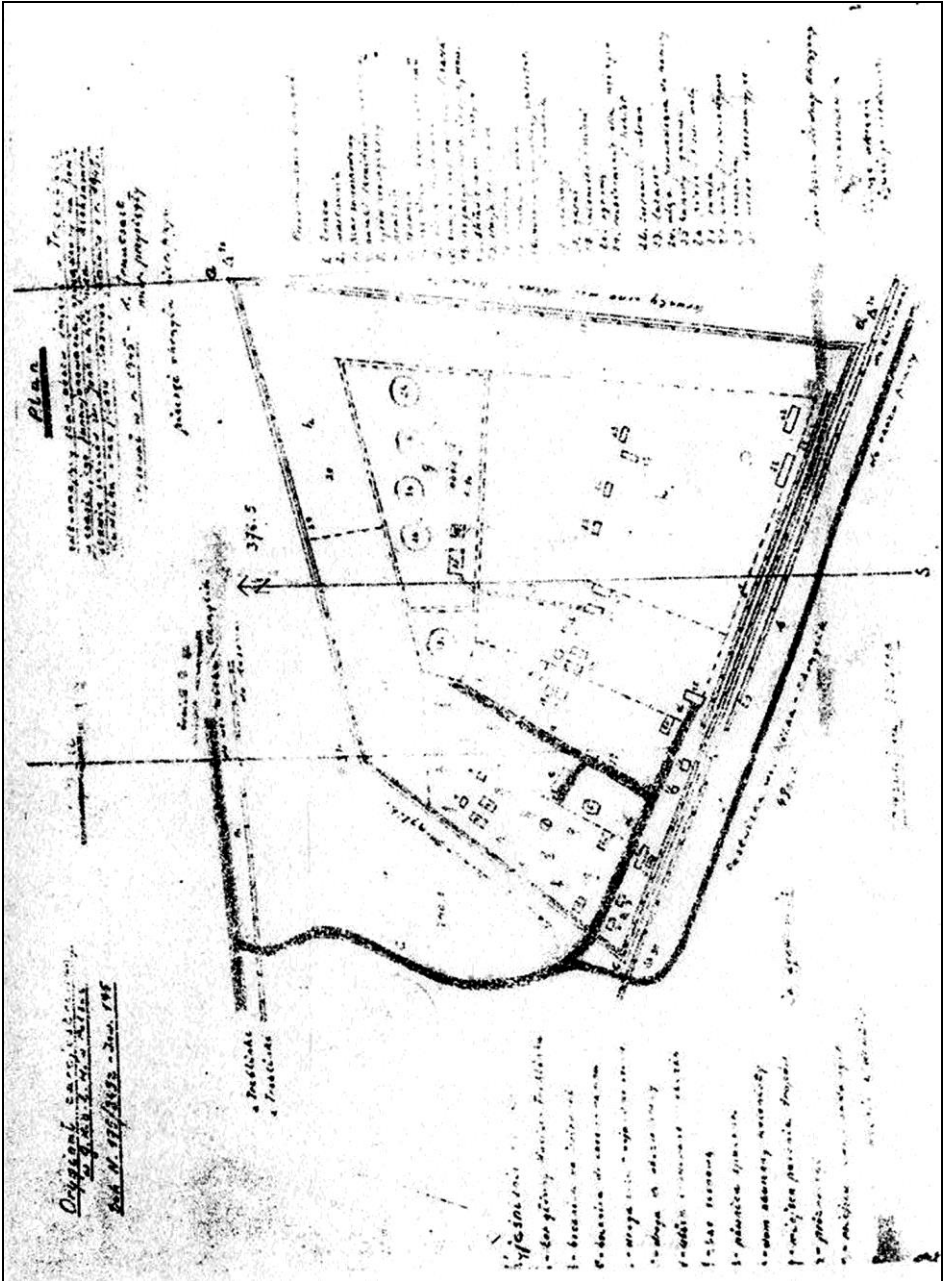

Document 7: Plan of Treblinka, based upon the plan of Trautsolt and testimony of J. Wiernik and A. Kudlik, reproduced in Stanisław Wojtczak, "Karny obóz pracy Treblinka I i ośrodek zagłady Treblinka II," in: *Biuletyn Głównej Komisji Badania Zbrodni Hitlerowskich w Polsce*, Warsaw 1975, XXVI, p. 166.

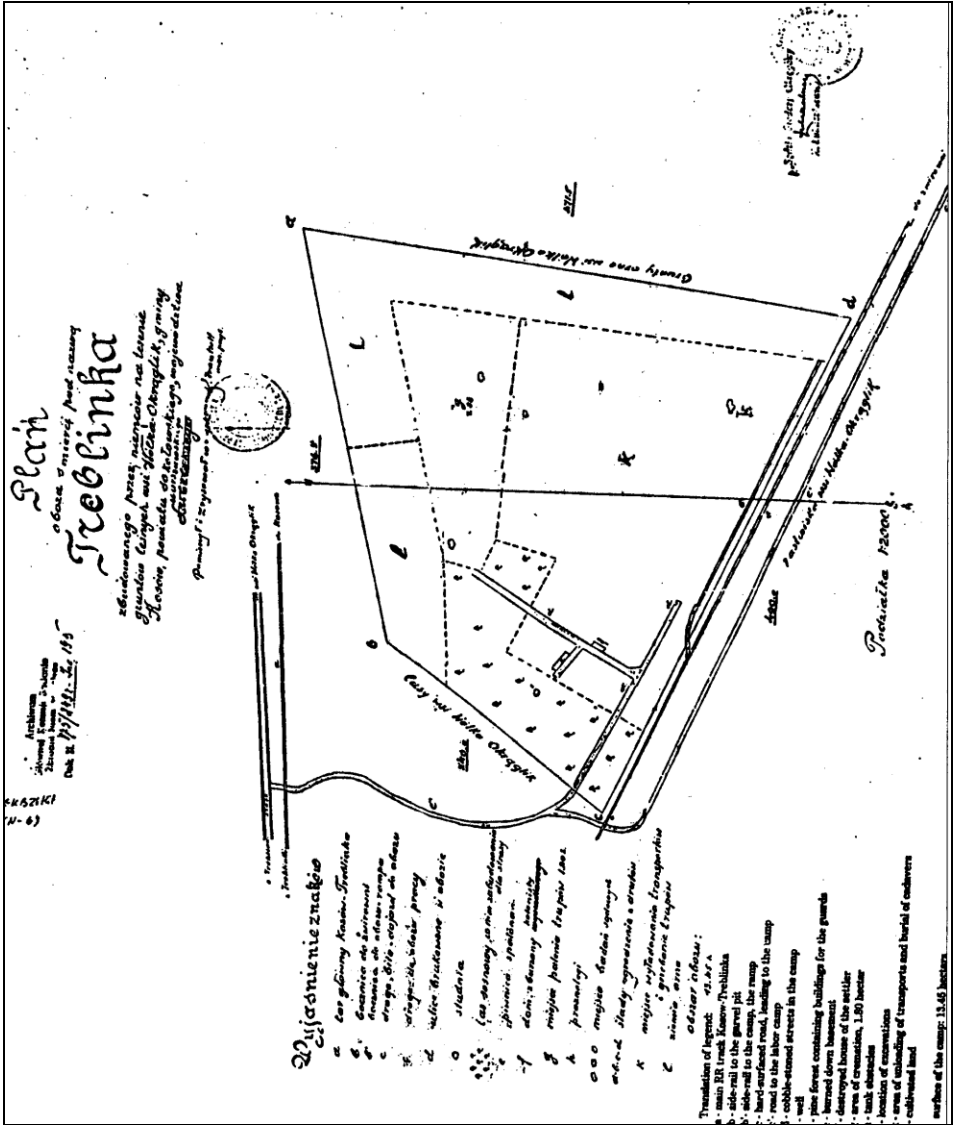

Document 8: Simplified Trautzolt Plan of Treblinka, reproduced by A. Neumaier in: "The Treblinka Holocaust," in: Germar Rudolf (ed.), *Dissecting the Holocaust*, 3rd ed., Castle Hill Publishers, Uckfield 2003, p. 489; according to the rubber stamp, this comes from the Archives of the Chief Commission for the Investigation of Hitler Crimes in Poland (Główna Komisja Badania Zbrodni Hitlerowskich w Polsce).

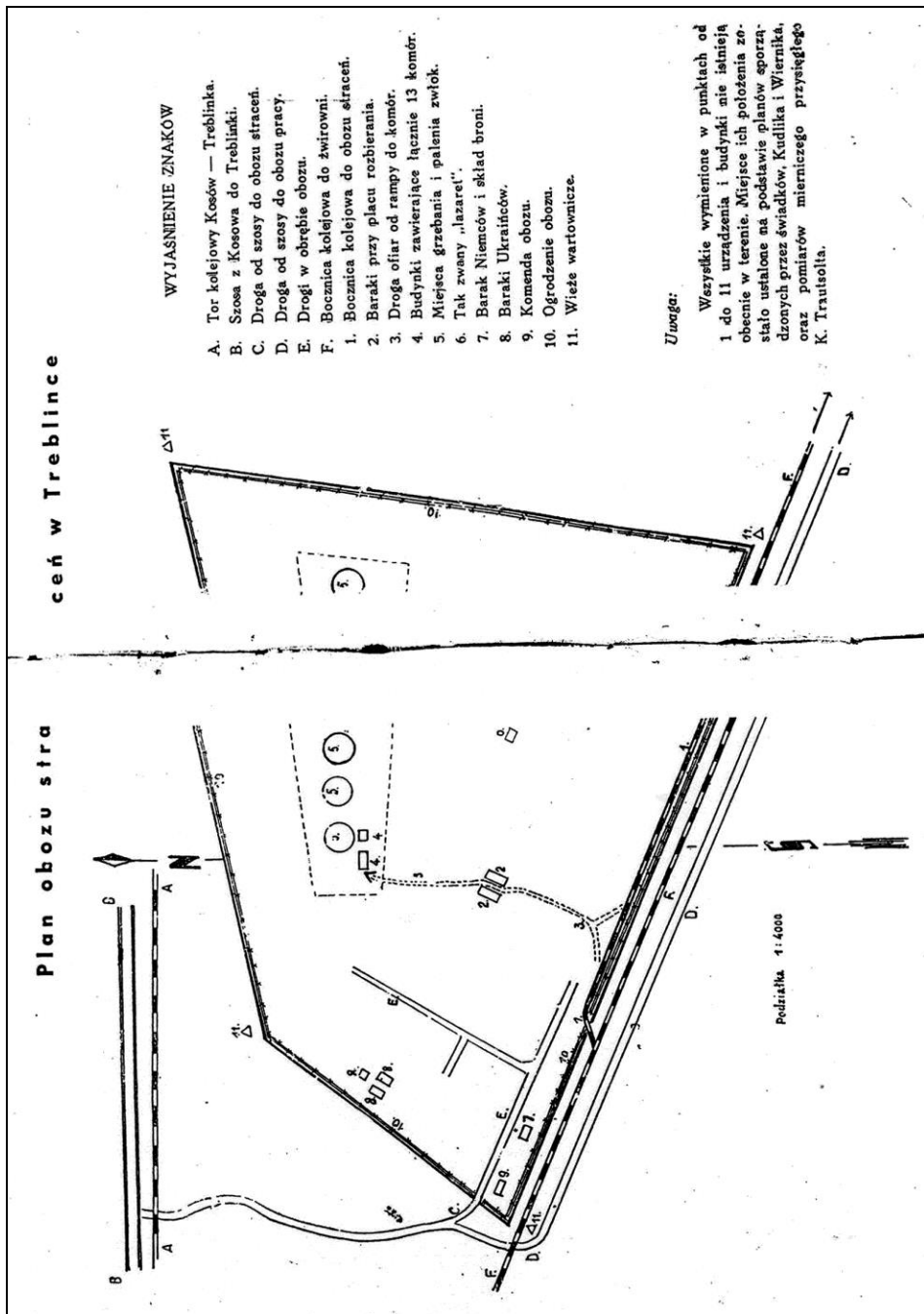

Document 9: Plan of Treblinka, drawn in 1945 by the surveyor K. Trautsołt.
 From: Z. Łukaszewicz, *Obóz straceń w Treblince*, Państwowy Instytut Wydawniczy, Warsaw 1946, pp. 54f.

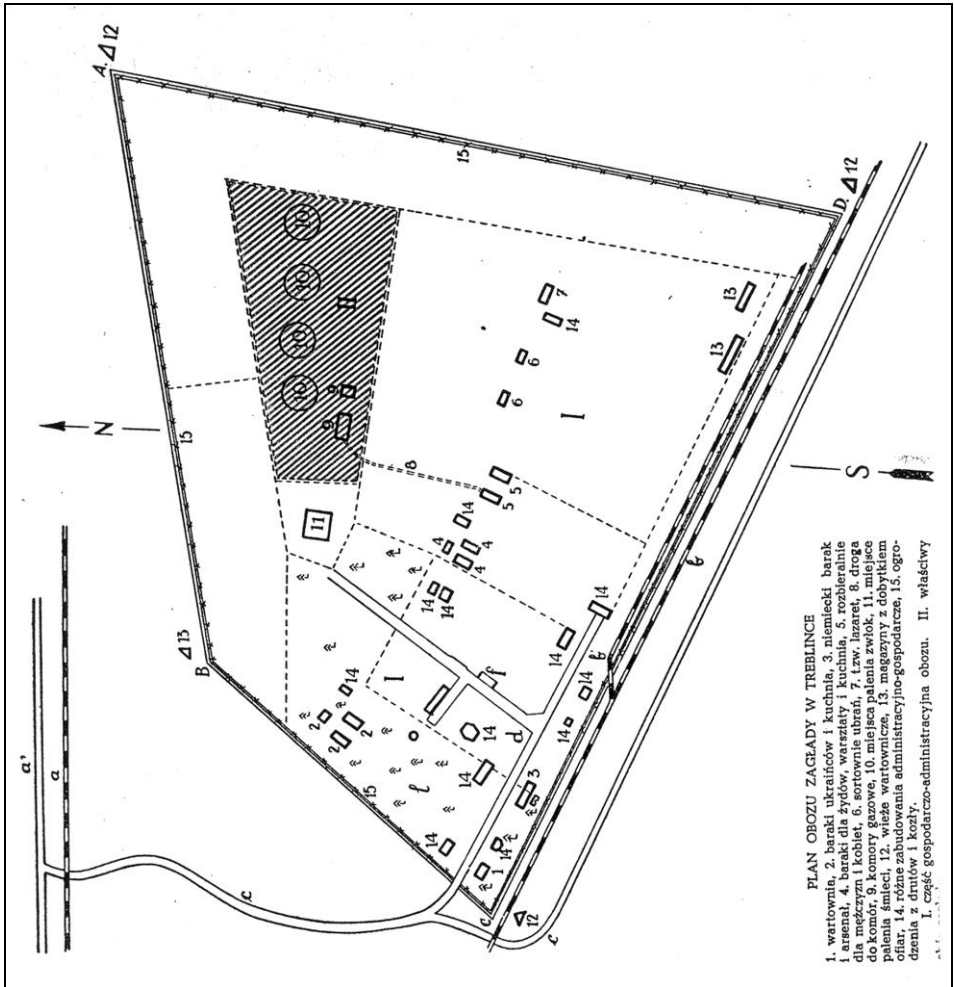

Document 10: Plan of Treblinka, published by Z. Łukaszkiewicz. From: *Biuletyn Głównej Komisji Badania Zbrodni niemieckich w Polsce, Posen 1946, Volume I, unnumbered page.*

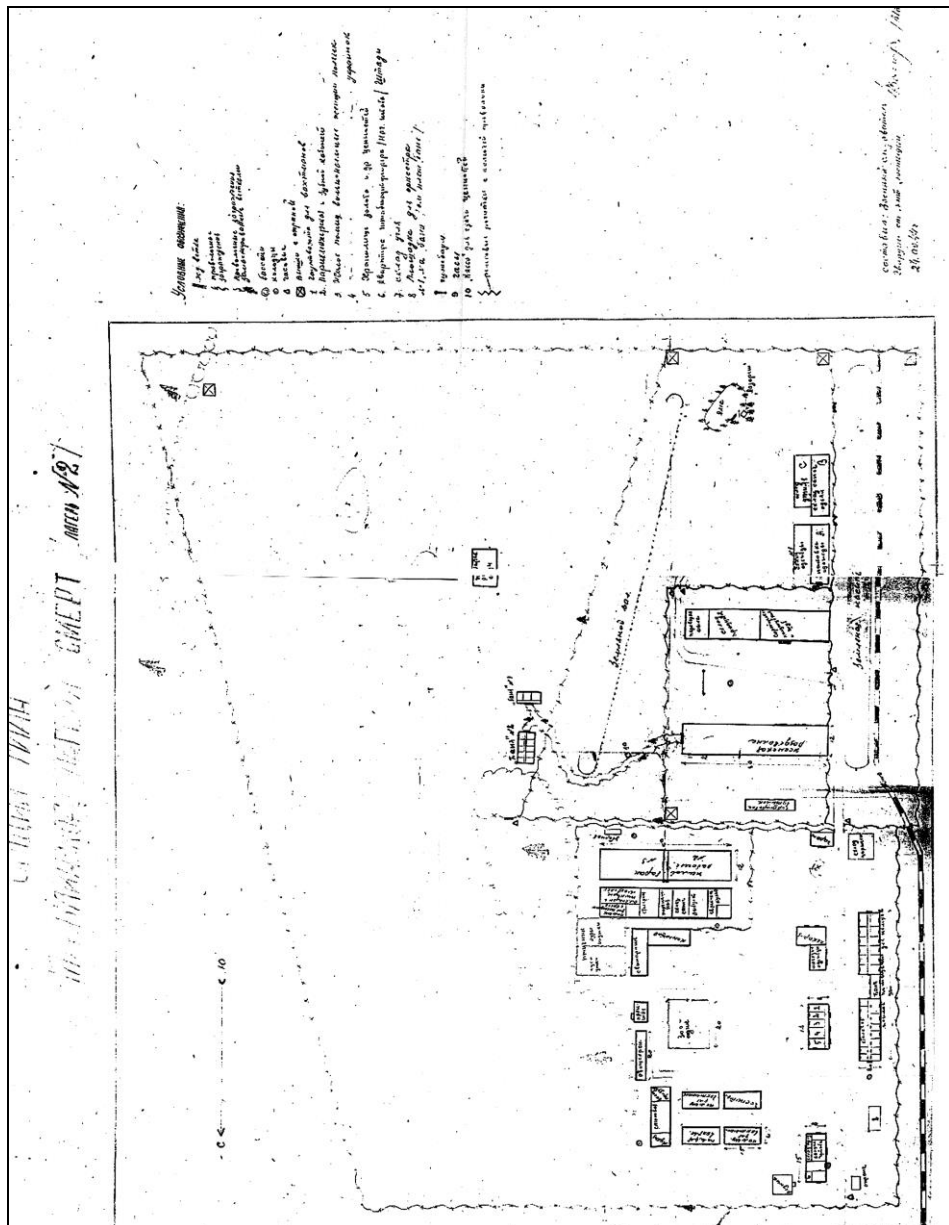

Document 11: Plan of Treblinka, drawn by the Soviets on September 24, 1944. GARF, 7445-2-134, p. 2.

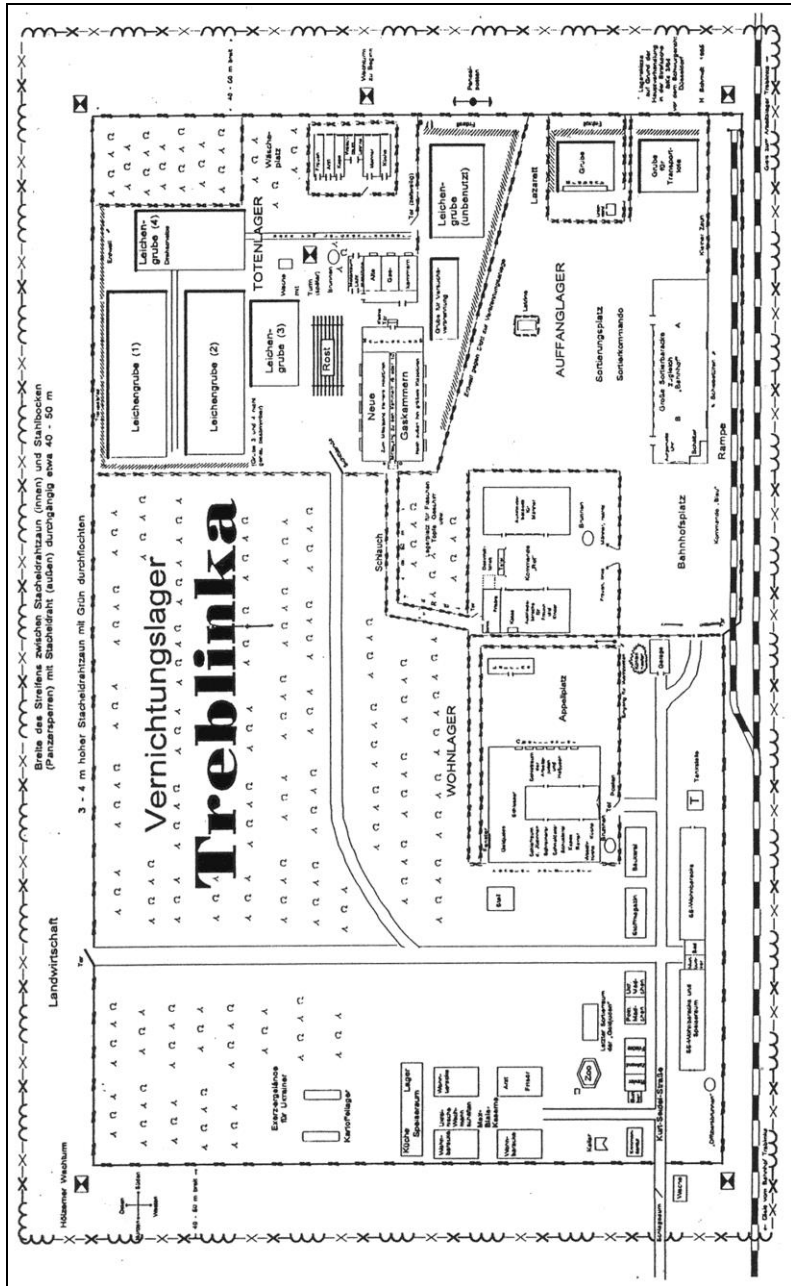

Document 12: Plan of Treblinka, drawn by the Chief State Prosecutor A. Spieß, presented at the first Treblinka trial in Düsseldorf. From: Manfred Burba, Treblinka. Ein NS-Vernichtungslager im Rahmen der "Aktion Reinhard", Göttingen 1995, pp. 14f.

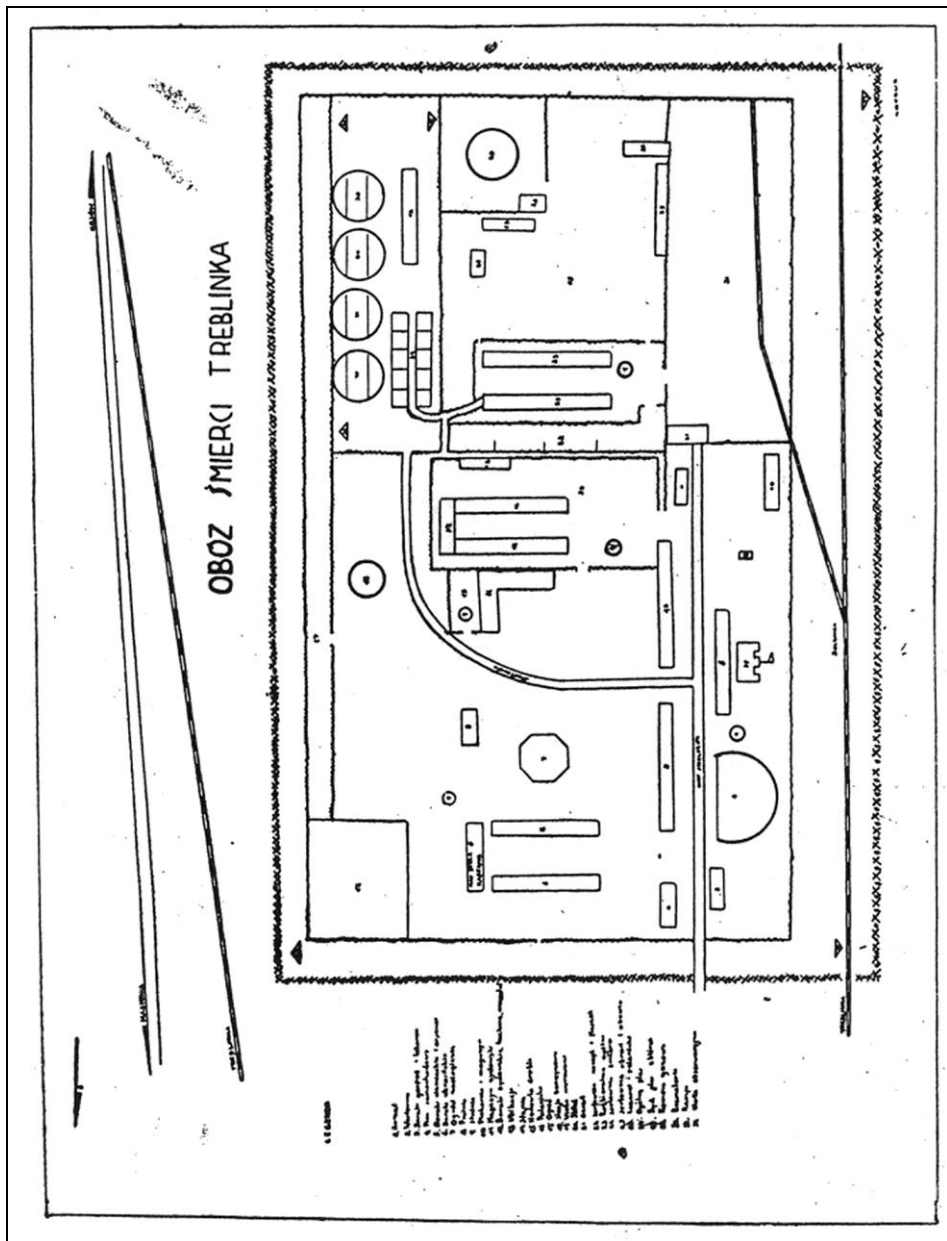

Document 13: Plan of Treblinka, drawn in 1946 by A. Kudlik. From: *Wydawnictwo Centralnej Żydowskiej Komisji Historycznej* (ed.), *Dokumenty i Materiały*, edited by N. Blumental, Lodz 1946, p. 12.

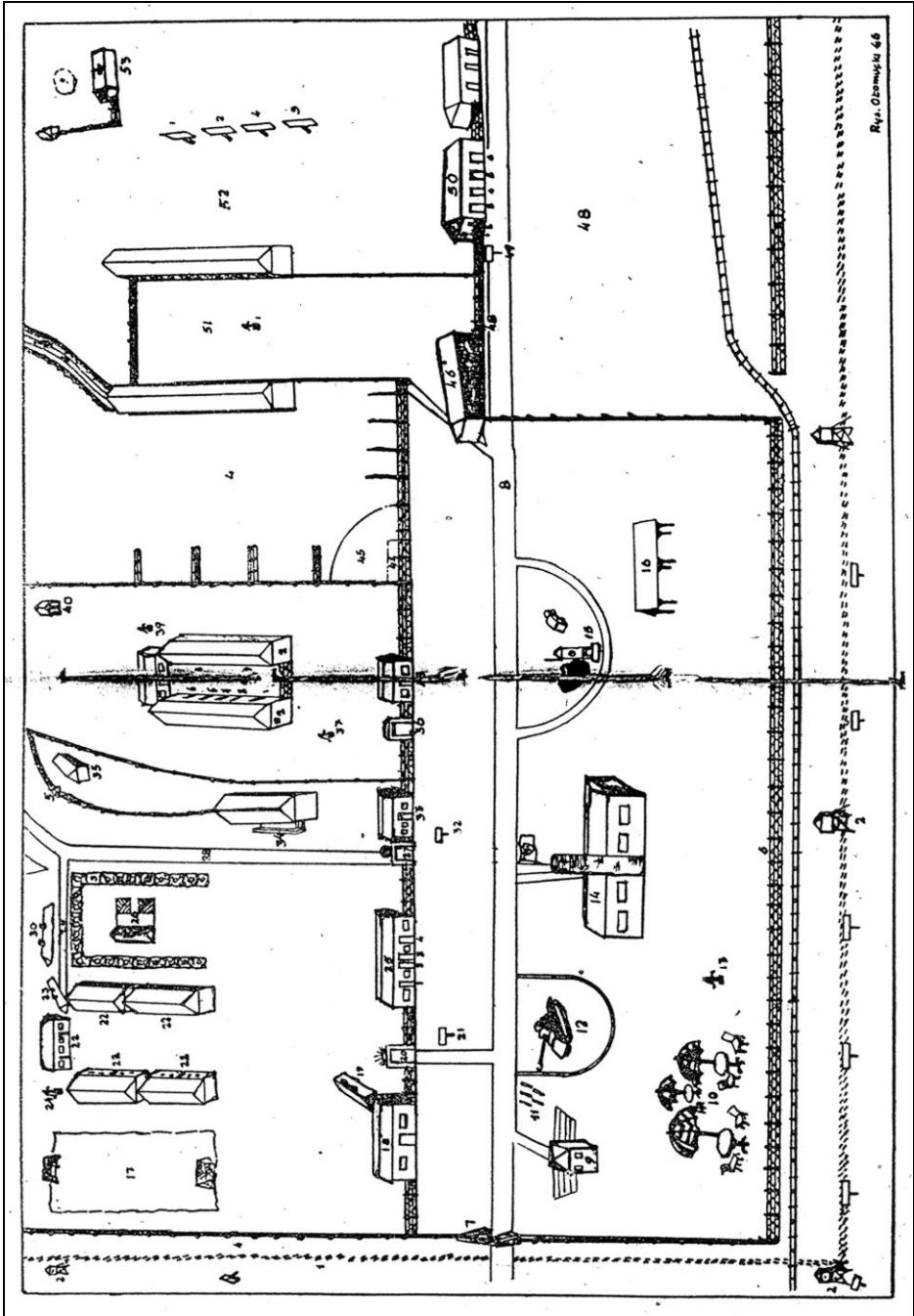

Document 14: Plan of Treblinka, drawn in 1946 by M. Laks. From: *Wydawnictwo Centralnej Żydowskiej Komisji Historycznej* (ed.), *Dokumenty i Materiały*, edited by N. Blumental, Lodz 1946, pp. 8f.

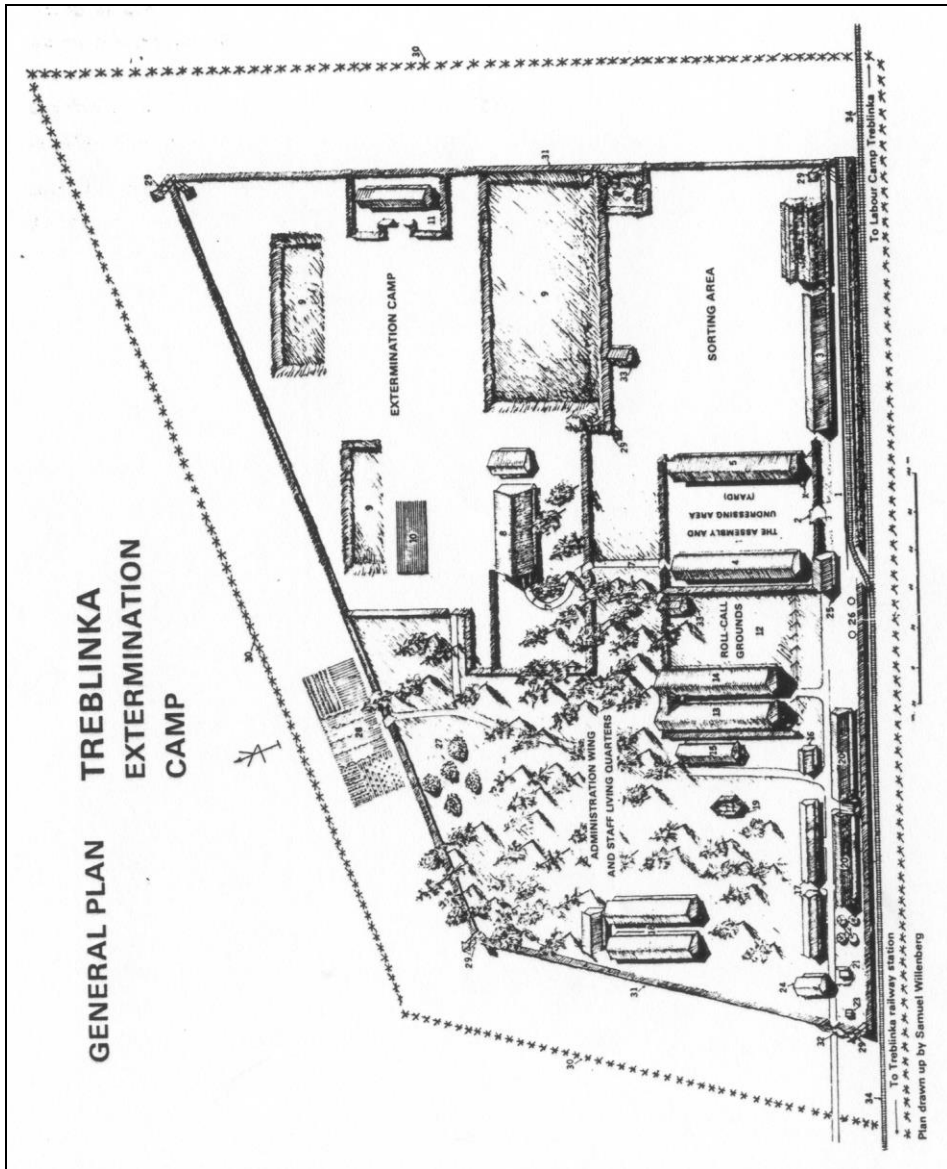

Document 15: Plan of Treblinka, drawn by S. Willenberg in 1984. From: S. Willenberg, *Revolt in Treblinka*, Żydowski Instytut Historyczny, Warsaw 1989, p. 6.

SS-Sonderkommando
T r e b l i n k a

Treblinka, den 4. Juni 1943

An den
SS- und Polizeiführer im Distrikt Lublin
Ausbildungslager Trawniki
z. Hd. SS-Hauptsturmführer Streibel

T r a w n i k i

Betr.: Lieferung von Kies.

Anbei erhalten Sie eine Rechnung der Deutschen Erd- und Steinwerke G.m.b.H. Auschwitz, (Oberschlesien) über an Sie gelieferten Kies. Ich bitte um baldige Überweisung des Betrages von ~~21.1579~~ 21.1579,90 an die Kreissparkasse Sokolow.

Der Versand von weiteren 30 Waggon Kies an Sie, erfolgt in den nächsten Tagen.

SS-Sonderkommando Treblinka

I.A.

Wiatary

Zbiory AP w Lublinie-Uscna.

139
77

75 *HS*
Trawniki, den 1. Juli 1943.

Betr. Kieslieferung nach Trawniki

Bez. Ihre Rechnungen vom 3./6., 13./6. u. 17./6. 43.

Inl. 3 alte Rechnungen und 2 neue Rechnungen dreifach

An die

Deutschen Erd- und Steinwerke G.m.b.H.

Kieswerk Treblinka

T r e b l i n k a Post Malkinia

Hiermit wird der Empfang von 100 Waggon Kies Bestätigt. Die letzten 20 Waggon mit 213,87 cbm mussten wegen Abfuhr und Lagerungsschwierigkeiten nach Lublin weitergeleitet werden. Der Kies wird dort für das Bauvorhaben des K.L. Lublin verwandt. Zur Durchführung einer einwandfreien Rechnungslegung ist es daher erforderlich, dass der gelieferte Kies getrennt für (Stindustrie Trawniki und K.L. Lublin in Rechnung gestellt wird. Die von hier neuerstellten Rechnungen bitte ich nach Unterschriftsleistung in zweifacher Ausfertigung an die Z e n t r a l b a u l e i t u n g

der Waffen SS u. Polizei

L u b l i n

Bernadinerstr. 6 zu senden. Anliegend werden die alten Rechnungen zurückgesandt.

Ji

Document 17: Letter of July 1, 1943, from the SS and Police Chief in the district of Lublin to the Deutsche Erd- und Steinwerke GmbH, Kieswerk Treblinka. WAPL, ZBL, 268, p. 75.

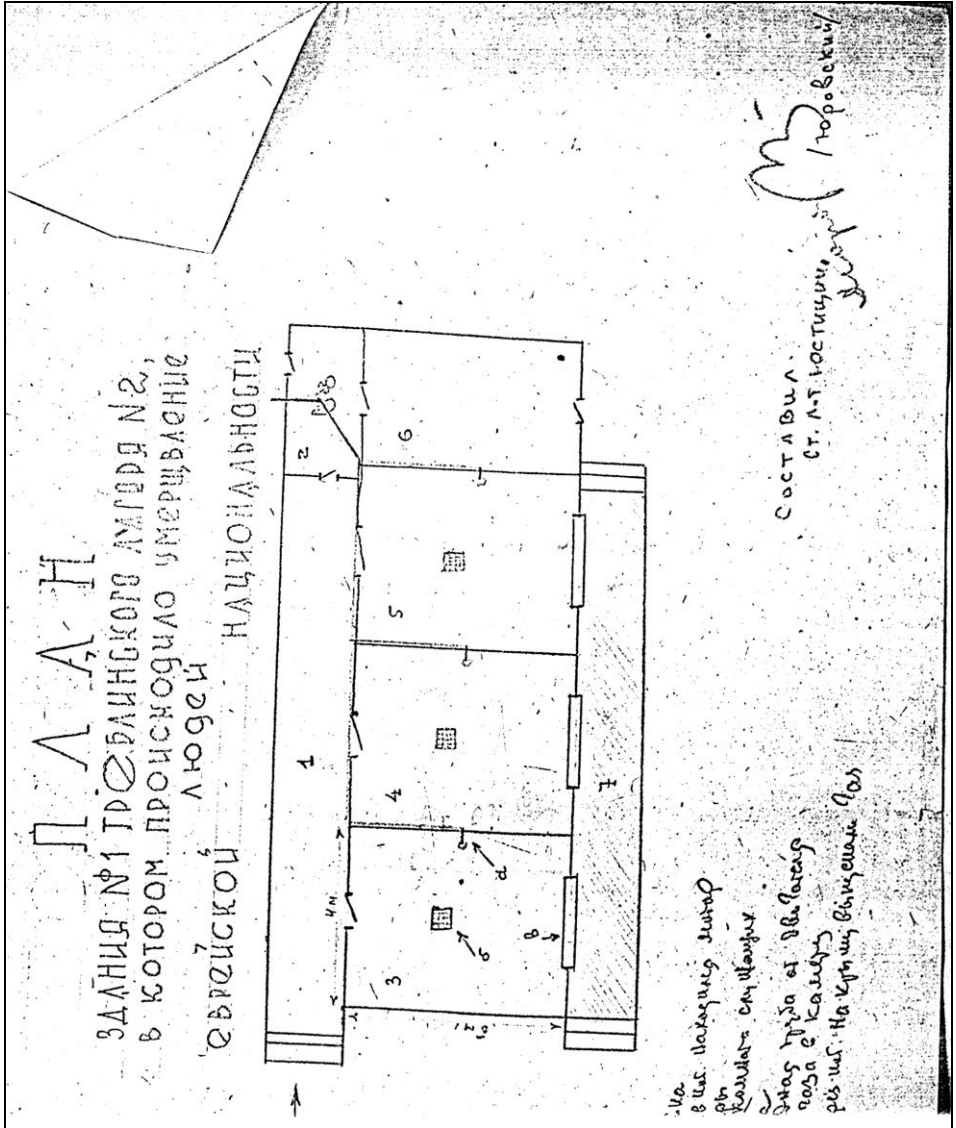

Document 18: Plan of the first alleged gassing facility of Treblinka, drawn by 1st Lt. Jurowski in August/September 1944. GARF, 7445-2-134, p. 39.

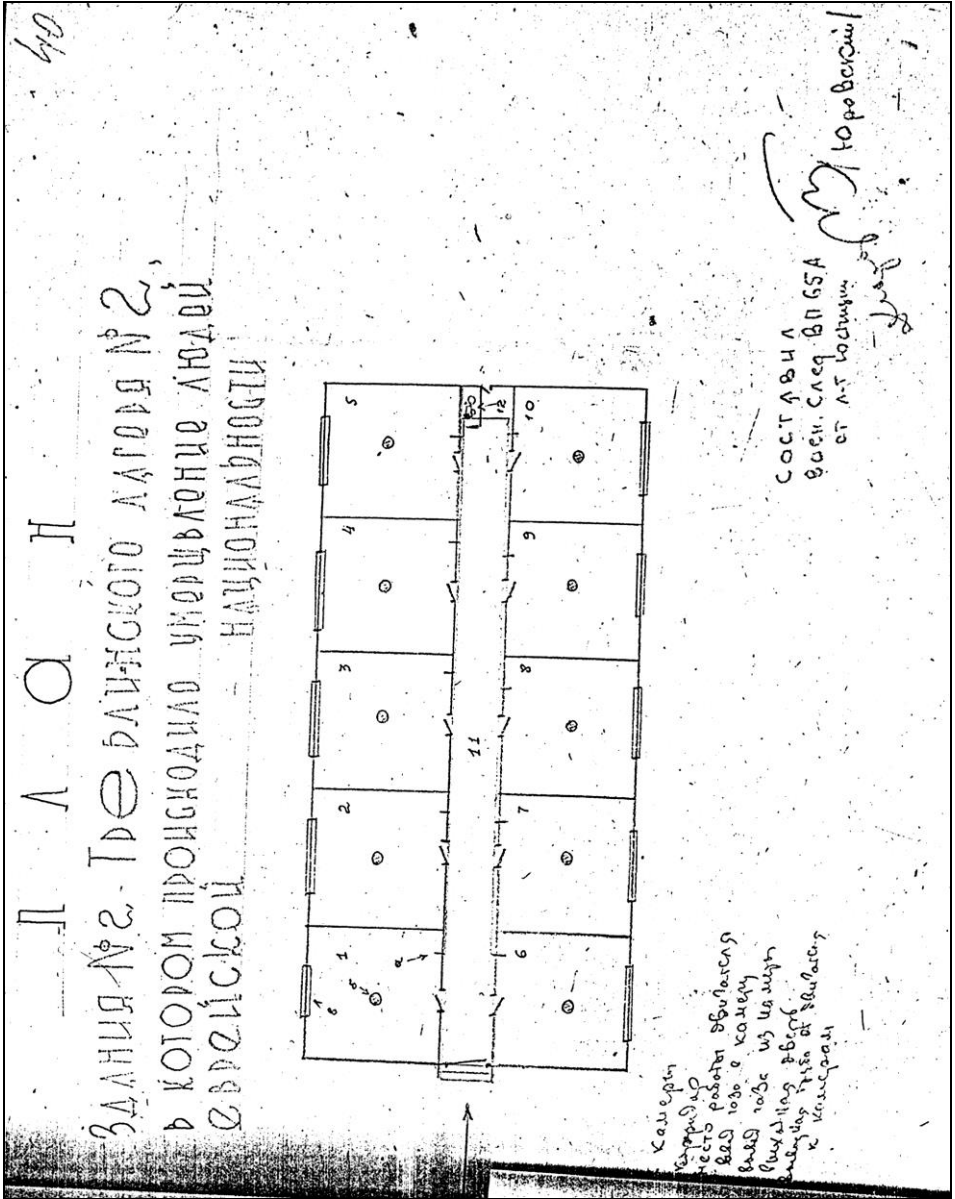

Document 19: Plan of the second alleged gassing facility of Treblinka, drawn by 1st Lt. Jurowski in August/September 1944. GARF, 7445-2-134, p. 40.

8 Chemische Untersuchungen an Auspuffgasen.

B. Chemische Untersuchungen an Auspuffgasen.

Versuchsprogramm, Versuchsprinzip, Schema zum Versuchsgang, Analysenapparatur, Versuchsgang, Versuchsprotokoll, tabellarische Übersicht und Besprechung der Gesamtresultate: Bei gleichen Motorbedingungen verbrennen sämtliche Brennstoffe gleichartig. Je höher die Belastung des Motors, desto vollständiger die Verbrennung. Bei Leerlauf neben CO, CH4 und H2, CH4 und Kohlenwasserstoffe in den Abgasen. Bei Volllast neben einem geringen Gehalt an H2, nur etwa 0,1% Kohlenwasserstoffe, ausser geringen Verbindungen, Alkohole, Azeotone, Phenole, Schwerföhlige Aldehyde und Säuren unter beiden Bedingungen.

Unsere Versuchen legten wir folgenden Versuchsplan zugrunde:

- Versuche bei Leerlauf bei Verwendung von Brennstoff A, B, D, E, F, G, H, I, K, L, M, N, O, P, Q, R, S, T, U, V, W, X, Y, Z, AA, AB, AC, AD, AE, AF, AG, AH, AI, AJ, AK, AL, AM, AN, AO, AP, AQ, AR, AS, AT, AU, AV, AW, AX, AY, AZ, BA, BB, BC, BD, BE, BF, BG, BH, BI, BJ, BK, BL, BM, BN, BO, BP, BQ, BR, BS, BT, BU, BV, BW, BX, BY, BZ, CA, CB, CC, CD, CE, CF, CG, CH, CI, CJ, CK, CL, CM, CN, CO, CP, CQ, CR, CS, CT, CU, CV, CW, CX, CY, CZ, DA, DB, DC, DD, DE, DF, DG, DH, DI, DJ, DK, DL, DM, DN, DO, DP, DQ, DR, DS, DT, DU, DV, DW, DX, DY, DZ, EA, EB, EC, ED, EE, EF, EG, EH, EI, EJ, EK, EL, EM, EN, EO, EP, EQ, ER, ES, ET, EU, EV, EW, EX, EY, EZ, FA, FB, FC, FD, FE, FF, FG, FH, FI, FJ, FK, FL, FM, FN, FO, FP, FQ, FR, FS, FT, FU, FV, FW, FX, FY, FZ, GA, GB, GC, GD, GE, GF, GG, GH, GI, GJ, GK, GL, GM, GN, GO, GP, GQ, GR, GS, GT, GU, GV, GW, GX, GY, GZ, HA, HB, HC, HD, HE, HF, HG, HH, HI, HJ, HK, HL, HM, HN, HO, HP, HQ, HR, HS, HT, HU, HV, HW, HX, HY, HZ, IA, IB, IC, ID, IE, IF, IG, IH, II, IJ, IK, IL, IM, IN, IO, IP, IQ, IR, IS, IT, IU, IV, IW, IX, IY, IZ, JA, JB, JC, JD, JE, JF, JG, JH, JI, JJ, JK, JL, JM, JN, JO, JP, JQ, JR, JS, JT, JU, JV, JW, JX, JY, JZ, KA, KB, KC, KD, KE, KF, KG, KH, KI, KJ, KK, KL, KM, KN, KO, KP, KQ, KR, KS, KT, KU, KV, KW, KX, KY, KZ, LA, LB, LC, LD, LE, LF, LG, LH, LI, LJ, LK, LL, LM, LN, LO, LP, LQ, LR, LS, LT, LU, LV, LW, LX, LY, LZ, MA, MB, MC, MD, ME, MF, MG, MH, MI, MJ, MK, ML, MM, MN, MO, MP, MQ, MR, MS, MT, MU, MV, MW, MX, MY, MZ, NA, NB, NC, ND, NE, NF, NG, NH, NI, NJ, NK, NL, NM, NN, NO, NP, NQ, NR, NS, NT, NU, NV, NW, NX, NY, NZ, OA, OB, OC, OD, OE, OF, OG, OH, OI, OJ, OK, OL, OM, ON, OO, OP, OQ, OR, OS, OT, OU, OV, OW, OX, OY, OZ, PA, PB, PC, PD, PE, PF, PG, PH, PI, PJ, PK, PL, PM, PN, PO, PP, PQ, PR, PS, PT, PU, PV, PW, PX, PY, PZ, QA, QB, QC, QD, QE, QF, QG, QH, QI, QJ, QK, QL, QM, QN, QO, QP, QQ, QR, QS, QT, QU, QV, QW, QX, QY, QZ, RA, RB, RC, RD, RE, RF, RG, RH, RI, RJ, RK, RL, RM, RN, RO, RP, RQ, RR, RS, RT, RU, RV, RW, RX, RY, RZ, SA, SB, SC, SD, SE, SF, SG, SH, SI, SJ, SK, SL, SM, SN, SO, SP, SQ, SR, SS, ST, SU, SV, SW, SX, SY, SZ, TA, TB, TC, TD, TE, TF, TG, TH, TI, TJ, TK, TL, TM, TN, TO, TP, TQ, TR, TS, TT, TU, TV, TW, TX, TY, TZ, UA, UB, UC, UD, UE, UF, UG, UH, UI, UJ, UK, UL, UM, UN, UO, UP, UQ, UR, US, UT, UY, UZ, VA, VB, VC, VD, VE, VF, VG, VH, VI, VJ, VK, VL, VM, VN, VO, VP, VQ, VR, VS, VT, VU, VV, VW, VX, VY, VZ, WA, WB, WC, WD, WE, WF, WG, WH, WI, WJ, WK, WL, WM, WN, WO, WP, WQ, WR, WS, WT, WU, WV, WW, WX, WY, WZ, XA, XB, XC, XD, XE, XF, XG, XH, XI, XJ, XK, XL, XM, XN, XO, XP, XQ, XR, XS, XT, XU, XV, XW, XX, XY, XZ, YA, YB, YC, YD, YE, YF, YG, YH, YI, YJ, YK, YL, YM, YN, YO, YP, YQ, YR, YS, YT, YU, YV, YW, YX, YY, YZ, ZA, ZB, ZC, ZD, ZE, ZF, ZG, ZH, ZI, ZJ, ZK, ZL, ZM, ZN, ZO, ZP, ZQ, ZR, ZS, ZT, ZU, ZV, ZW, ZX, ZY, ZZ

Außerdem wurde noch ein Versuch angestellt, bei welchem die normale Vergaserdase 70 gegen eine 85 ausgetauscht, also mit Brennstoffüberschuß (fettes Gemisch) gearbeitet wurde. Hierbei wurde Brennstoff D benutzt.

1. Untersuchungsmethode.

Das Prinzip ist kurz folgendes: Die Abgase werden fraktioniert — kondensiert und die einzelnen Kondensate nach dem Stockischen Hochvakuumverfahren*, die nicht kondensierbaren Bestandteile mit Hilfe der üblichen Methoden analysiert. Die Überlegenheit dieser Methode gegenüber der üblichen direkten Gasanalyse besteht nicht nur in der Fraktionierung der in den Auspuffgasen enthaltenen Stoffe, sondern vor allen Dingen in der außerordentlich starken Anreicherung der Komponenten, die in den Auspuffgasen nur in geringen Mengen vorhanden sind.

* Wir begnügen uns hierbei, nur die Abgase des leichtest flüchtigen und des schwerst flüchtigen Benzins der Untersuchungsreihe mit einem Antiklopfmittelzusatz zu untersuchen. † De Benzol keine Tendenz zum Klopfen hat, läßtten Zusatzes von Fe(CO)5 zu Benzol für die Praxis keinen Sinn. ‡ Hier erübrigen sich Versuche mit Zusatzmitteln, da zwischen der Wirkung des Zusatzes Benzol und der Wirkung von Vollast grundsätzlich keine Unterschiede bestehen. § Die Wirkung der Vollast auf die Abgaszusammensetzung besond bei Leerlauf als bei Vollast, wo nur relativ wenig unverbrannte Anteile in den Abgasen enthalten sind, untersucht wird. ¶ Stock 1914, 1917, 1918 (210); siehe auch unsere Ausführungen auf S.111f.

9 Untersuchungsmethode.

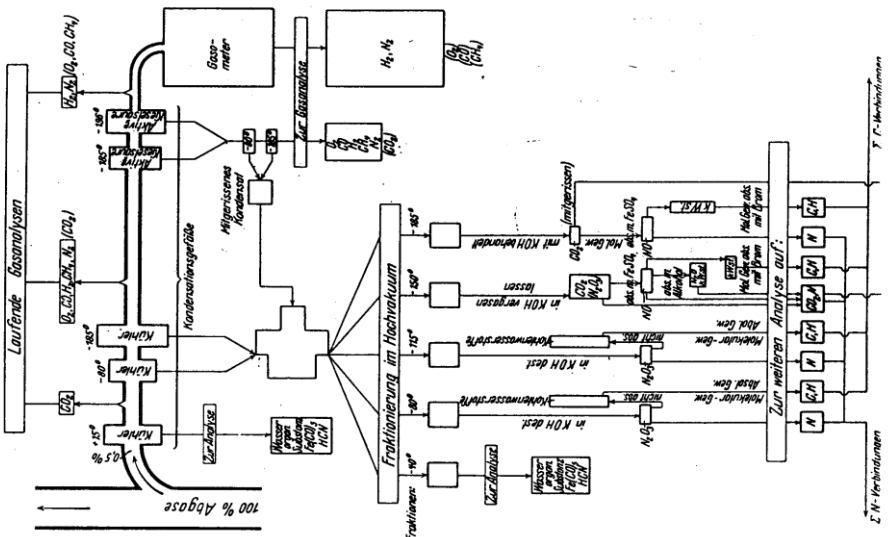

Georg Grabarz, Elektromeister, Gleiwitz, Ruf 2198		Blatt 1	Datum 10. 11. 40	
Lfd. Nr.	Menge	Gegenstand	Einheitspreis 26	Gesamtpreis 26
1)	1	<p>Kostenveranschlagung über Notstromanlage in K.L. Au.</p> <hr/> <p>stehenden, einfachwirkenden 7 -Zylinder 4-Takt-Deutz-Dieselmotor Type V7M 436</p> <p>Dauerleistung : 350 PS Drehzahl: 500 Upm Überlastbarkeit kurzzeitig : 20% Kraftstoffverbrauch: 170 gr/ PSeh bei Vollast 170 gr/ PSeh bei 3/4 " 185 gr/ PSeh bei 1/2 " mit 10 % Toleranz für die Gewähr, bei Ver- wendung von geeignetem Kraftstoff mit einem Mindest-Heizwert von Hue 10.000 kcal/kg. Schmierölverbrauch: 0,88 kg./Std. ohne Ge- währ, bei Reinigung und Wiederverwendung des gebrauchten Öles. Kühlwasserverbrauch: 12 l/ PSeh bei 10°C Zufluss- und 70°C Ab- flusstemperatur, ohne Gewähr.</p> <p>Die Leistung wird erzielt in Meereshöhe bei 20° C Maschinenraumtemperatur und ver- mindert sich bei Aufstellung in Höhen über NN für je 100 m um 1% und bei Umgebungs- temperaturen über 20°C für jede weiteren 2,5° C um 1%. Beträgt die Summe beider Leistungs-Minderungen nicht mehr als 5%, so kann sie vernachlässigt werden.</p> <p><u>Lieferungsumfang:</u> Motor mit Kuppelflansch an der Kurbelwelle und Kupplungsbolzen, Schaltwerk, Ölkühler, umschaltbares Ölfilter, Hand- flügelpumpe zum Vorschmieren der Lager, eingebaut Schmierölpumpe und Zylinder- schmierapparat, Schmieröldruckmesser, Druckluftanlassvorrichtung einschliess- lich Anlassgefäß mit Manometer und Druck- luftleitung, Aufladeventil, Drehzahlverstellvorrichtung für Handbe- tätigung + 5%, Kraftstoffbehälter ohne Unterstützungen mit Inhaltsanzeiger und Handpumpe, Kraft- stofffilter ohne Leitungen, Leckölbehälter, angebautes und wassergekühltes Auspuff- sammelrohr, Auspuffableitungsrohr bis unter Flur, Auspufftopf ohne Unterstützungen Auspufftemperatur-Überwachungsanlage,</p>		

Document 21: Cost estimate of the Georg Grabarz firm, Gleiwitz, dated November 10, 1940, for emergency power supply in the Auschwitz concentration camp. RGVA, 502-1-128, pp. 45-49, with page 45 reproduced here.

DER REICHSKOMMISSAR FÜR DAS OSTLAND
Fernschreibstelle

Vermehrte der Fernschreibstelle.	Angenommen:	weiter an	Datum	Uhrzeit	durch
	von: <i>D. K. Kammern</i>				
	durch: <i>Kammern</i>				
	Datum: <i>31/7.42</i> Uhrzeit: <i>19:40</i>				

Reichskommissar
für das Ostland
1 AUG 1942
Hauptabt. *117*
Mittelteilung

*115-830
BT-1*

Fernschreiben

GEHEIM

Dringlichkeitsvermerke:
Fernspr.-Nr. des Auflieferers:

Der Reichskommissar für das Ostland
Tgb. Nr. *117 12 5*

Gepirini

0967

++ a Ljxx 945 31/7 1545 dsz ++
= an reichskommissar fuer das ostland gauleiter hinrich L o h s e ,
niga = ohne mich, den generalkommissar, oder den
zustandigen ss- und polizeifuehrer oder den
sd zu benachrichtigen. erhielt ludtgau 1.000 juden aus warschau zu a
nn zu arbeit nach *...*
weiteren selbststaendiger judenfuehrer und behinderung weiterer selbststaendiger
judenfuehrer /
partisanengefahr durch juden stest vorzee nni stats vergruesent = or
nn = den generalkommissar fuer weiszruh n fuer weiszruthenien,
k u b e ++ ++

*Wunsch - Ich habe Sie besucht. Sie sind
R. K. Kommissar für das Ostland. Ich würde gerne
für Sie arbeiten, da Sie die Aufgabe der
Aufsicht über die Juden in der Ostland-Region
übernehmen. Ich bin bereit, meine
Kräfte für Sie einzusetzen und Ihre Arbeit zu
erleichtern.*

Document 22: Telegram of July 31, 1942, from the Reichskommissar for White Russia, Wilhelm Kube, to the Reichskommissar for the Ostland, Hinrich Lohse. GARF, 7445-2-145, p. 80.

7
 Lublin, den 21.8.1943

Waffen-III
 Konzentrationslager Lublin
 Politische Abteilung

An
~~Abteilung III, Lager Lublin, Selbstbehaltungs-Erteilungsbüro~~

Vom II- und Polizeiführer Lublin wurden am 20.8.1943
 2031 poln.-Juden aus Bialystok
 ins KL Lublin eingeliefert.

Klein-Schr.

Document 24: Letter of August 21, 1943, on the subject of arrival of a transport with 2,031 Jews from Bialystok, from the Political Department of the Lublin KL to Department III, the camp office and communications traffic room. GARF, 7021-107-3, p. 258.

Photographs



Photo 1: Treblinka. A large portion of the camp grounds was paved over with concrete, and 17,000 cement blocks evocative of tombstones have been placed there. © Carlo Mattogno, 1997.



Photo 2: Treblinka. Stone monument in the center of the camp. © Carlo Mattogno, 1997.



Photo 3: Treblinka. One of the memorial stones erected at the camp entrance. © Carlo Mattogno, 1997.



Photo 4: Treblinka. Cross-ties made of concrete, flanked by a platform also built of concrete, symbolize the railway line and the train platform of the camp. © Carlo Mattogno, 1997.



Photo 5: Treblinka. Only a spacious meadow bordered by fir trees has remained of the camp. © Carlo Mattogno, 1997.



Photo 6: The gravel pit of Treblinka I. © Carlo Mattogno, 1997.



Photo 7: Cemetery where Polish prisoners who died in Treblinka I rest. © Carlo Mattogno, 1997.



Photo 8: Treblinka I. The concrete foundations, on which the barracks stood, can be seen on the camp grounds. © Carlo Mattogno, 1997.



Photo 9: Treblinka I. One of the eight concrete foundations, on which the barracks stood. © Carlo Mattogno, 1997.



Photo 10: Aerial photograph of Treblinka from May 15, 1944. From: John C. Ball, Air Photo Evidence, Ball Resource Services, Delta/B.C., 1992, p. 86; p. 130 in Rudolf's 2020 edition.

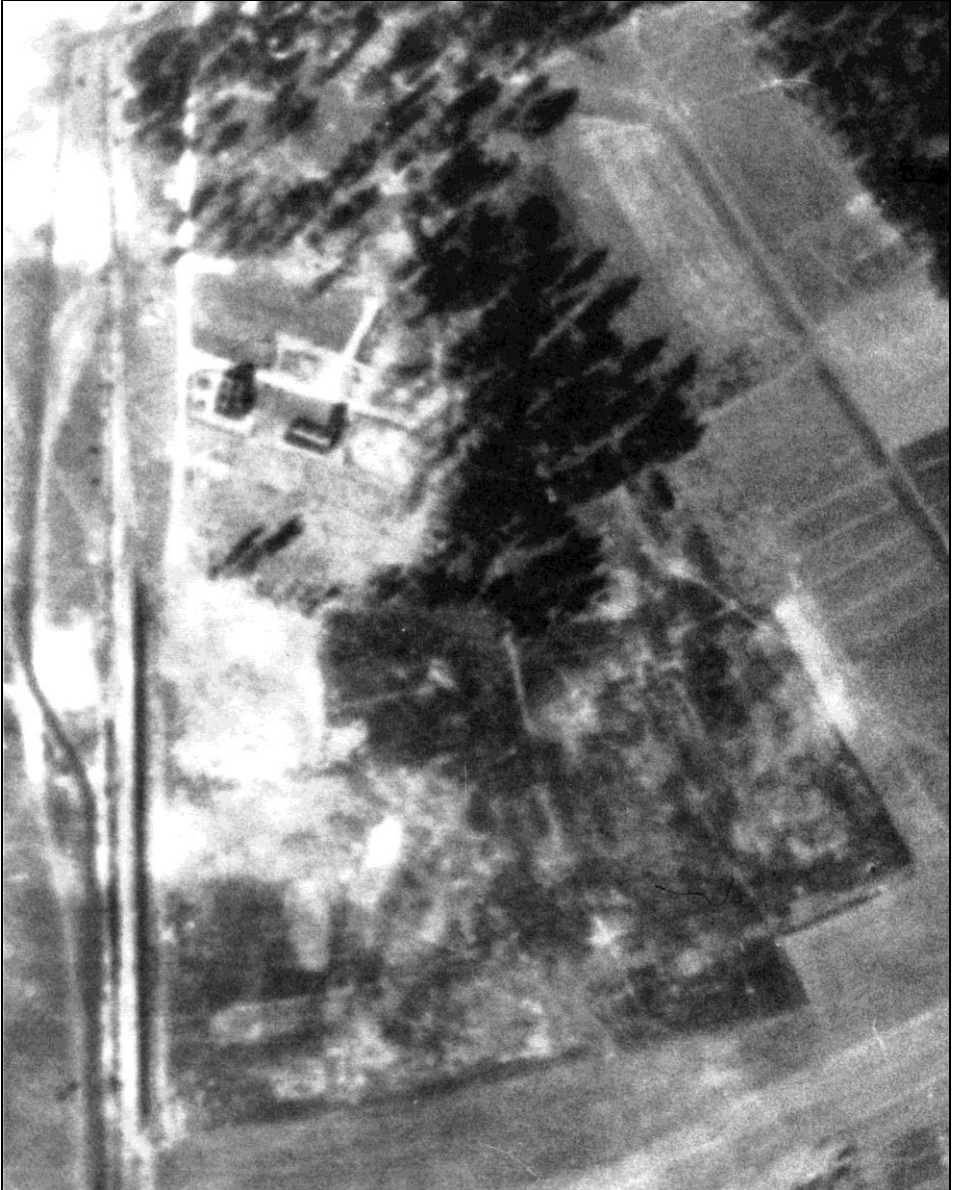

Photo 11: Aerial photograph of Treblinka from November 1944. From: John C. Ball, Air Photo Evidence, Ball Resource Services, Delta/B.C., 1992, p. 87; p. 131 in Rudolf's 2020 edition.

Abbreviations

- AMS:** Archiwum Muzeum Stutthof (Archive of the Stutthof Museum), Stutthof
- APL:** Archiwum Państwowe w Łodzi (State Museum in Lodz), Lodz
- BAK:** Bundesarchiv Koblenz (Federal Archive), Coblenz
- CDJC:** Centre de Documentation Juive Contemporaine (Contemporary Jewish Documentation Center), Paris
- DAL:** Derzharchive L'vivs'koi Oblasti (State Archive of the Lemberg District), Lemberg
- GARF:** Gosudarstvenni Archiv Rossiiskoi Federatsii (State Archive of the Russian Federation), Moscow
- HI:** Hoover Institution Library and Archives, Stanford
- IMT/G:** The Trial against the Main War Criminals before the International Military Tribunal, Nuremberg, 1945-1946/Der Prozeß gegen die Hauptkriegsverbrecher vor dem Internationalen Militärgerichtshof, Nuremberg 1947
- NARA:** National Archives Record Administration, Washington; D.C.
- NARB:** Natsionalnii Archiv Respubliki Belarus (National Archive of the Republic of White Russia), Minsk
- PA:** Politisches Archiv des Auswärtigen Amtes (Political Archive of the Foreign Office), Berlin
- RGVA:** Rossiiskii Gosudarstvenni Vojennii Archiv (Russian State War Archive), formerly TCIDK: Tsentr Chranenia Istoriko-dokumental'nich Kollektzii (Center for the Preservation of Historical Document Collections), Moscow
- ROD:** Rijksinstituut voor Oorlogsdocumentatie (Reich Institute for War Documentation), Amsterdam
- VHA:** Vojenský Historický Archiv (Military Historical Archiv), Prague
- WAPL:** Wojewódzkie Archiwum Państwowe w Lublinie (State Archive of the Lublin District), Lublin

Bibliography

- Abate, Dante, Caroline Sturdy-Colls, “A multi-level and multi-sensor documentation approach of the Treblinka extermination and labor camps,” *Journal of Cultural Heritage*, Vol. 34 (2018), pp. 129-135.
- *Actes et documents du Saint Siège relatifs à la seconde guerre mondiale: Le Saint Siège et les victimes de la guerre*. Janvier 1941-Décembre 1942, Libreria Editrice Vaticana, Vatican City 1975.
- Allen, Andrew, “Die US-Nazijäger vom OSI und der Holocaust-Mythos”, in: *Vierteljahrshefte für freie Geschichtsforschung*, No. 4/2001, p. 428-430.
- Allen, Andrew, “The Office of Special Investigations and the Holocaust Myth,” <https://codoh.com/library/document/the-office-of-special-investigations-and-the/>
- Apenszlak, Jacob (ed.), *The Black Book of Polish Jewry*, American Federation for Polish Jews, New York 1943.
- Arad, Yitzhak, *Belzec, Sobibor, Treblinka: The Operation Reinhard Death Camps*, Indiana University Press, Bloomington and Indianapolis 1987.
- Arndt, Ino, Wolfgang Scheffler, “Organisierter Massenmord an Juden in nationalsozialistischen Vernichtungslagern”, in: *Vierteljahrshefte für Zeitgeschichte*, 2, 1976.
- Auswärtiges Amt (ed.), *Amtliches Material zum Massenmord von Katyn*, Berlin 1943.
- Auswärtiges Amt (ed.), *Amtliches Material zum Massenmord von Winniza*, Berlin 1944.
- Aynat, Enrique, *Estudios sobre el “Holocausto”*, Valencia 1994.
- Ball, John C., *Air Photo Evidence*, Ball Resource Services, Delta/B.C. 1992. For the latest edition see Rudolf 2020.
- Baranowski, Julian, *The Lodz Ghetto 1940-1944*. Vademecum, Archiwum Państwowe w Łodzi, Łodz 1999.
- Benz, Wolfgang (ed.), *Dimension des Völkermords*, R. Oldenbourg Verlag, Munich 1991.
- Berenstein, Tatjana, “Eksterminacja ludności żydowskiej w dystrykcje Galicja”, in: *Biuletyn Żydowskiego Instytutu Historycznego w Polsce*, No. 61, 1967.
- Berenstein, Adam Rutkowski, “Żydzi w obozie koncentracyjnym Majdanek”, in: *Biuletyn Żydowskiego Instytutu Historycznego w Polsce*, No. 58, 1966.
- Berg, Friedrich P., “The Diesel Gas Chambers: Myth within a Myth”, *Journal of Historical Review*, 5(1) 1984, pp. 15-46.
- Blatt, Thomas (Tovi), Sobibor. *The Forgotten Revolt. A Survivor’s Report*, H.E.P. Issaquah, 1998.
- Bohlinger, Roland (ed.), *Die Stellungnahme der Leitung der Gedenkstätte Haus der Wannsee-Konferenz zu dem von Bohlinger und Ney verfaßten Gutachten zur Frage der Echtheit des sogenannten Wannsee-Protokolls und der dazugehörigen Schriftstücke*, Verlag für ganzheitliche Forschung, Viöl 1995.
- Bohlinger, Roland, Johannes P. Ney, *Zur Frage der Echtheit des Wansee-Protokolls*, 2nd ed., Verlag für ganzheitliche Forschung und Kultur, Viöl 1994.
- Boisdefeu, Jean-Marie, *La controverse sur l’extermination des juifs par les allemands. Tome 2: Réalités de la “solution finale”*, Vrij Historisch Onderzoek, Antwerp 1996.
- Boisdefeu, Jean-Marie, *La controverse sur l’extermination des juifs par les allemands. Corrigenda et addenda*, Vrij Historisch Onderzoek, Antwerp 1998.
- Brechtken, Magnus, “Madagaskar für die Juden”. *Antisemitische Idee und Praxis 1885-1945*, R. Oldenbourg Verlag, Munich 1998.
- Broszat, Martin, “Hitler und die Genesis der ‘Endlösung’. Aus Anlaß der Thesen David Irving”, in: *Vierteljahrshefte für Zeitgeschichte*, No. 25/4, 1977.
- Buchheim, Hans, Martin Broszat, Hans-Adolf Jacobsen, Helmut Krausnick, *Anatomie des SS-Staates*, Deutscher Taschenbuch Verlag, Munich 1982.

- Buchheim, Hans, Martin Broszat, Hans-Adolf Jacobsen, Helmut Krausnick, *Anatomy of the SS State*, Collins, London 1968.
- Burba, Manfred, *Treblinka. Ein NS-Vernichtungslager im Rahmen der "Aktion Reinhard"*, Göttingen 1995.
- Butz, Arthur R., *The Hoax of the Twentieth Century*, 4th ed., Castle Hill Publishers, Uckfield 2015.
- *Calendario del popolo*, No. 468, July 1984.
- Carnier, Pier Arrigo, *Lo sterminio mancato. La dominazione nazista nel Veneto orientale 1943-1945*, Mursia, Milano 1982.
- Central Commission for Investigation of German Crimes in Poland (ed.), *German Crimes in Poland*, Warsaw 1946.
- Charles, Jonathan, "The Hidden Graves of the Holocaust", BBC Radio 4, 23 Jan. 2012; 30:00; www.bbc.co.uk/iplayer/episode/b019rlns/The_Hidden_Graves_of_the_Holocaust/
- Chelain, André, *La thèse de Nantes et l'affaire Roques*, Polémiques, Paris 1988.
- Chernoglazova, Raisa A, *Judenfrei! Svobodno ot evreev!* Istorija Minskovo Getto v dokumentach "Asobny Dakh", Minsk 1999.
- Colloque de l'Ecole des Hauts Etudes en science sociale, *L'Allemagne nazie et le génocide juif*, Galliard-Le Seuil, Paris 1985.
- Colombo, G., *Manuale dell'ingegnere civile ed industriale*, Ulrico Hoepli Editore, Milan 1926.
- Conan, Eric, *L'Express*, Paris, February 27, 1997.
- Czarkowski, Ryszard, *Cienom Treblinki*, Wydawnictwo Ministerstwa Obrony Narodowej, Warsaw 1989.
- Czech, Danuta, "Kalendarium der Ereignisse im Konzentrationslager Auschwitz-Birkenau", in: *Hefte von Auschwitz, Volume 3*, Wydawnictwo Państwowego Muzeum w Oświęcimiu 1960.
- Czech, Danuta, *Auschwitz Chronicle, 1939-1945*, H. Holt, New York 1990.
- Daeningckx, Didier, "De Treblinka à Bordeaux", in: *Revue de la Shoah*, May-August 1999.
- Dawidowicz, Lucy, *The Holocaust Reader*, Berman House, New York 1976.
- Dawidowicz, Lucy, *The War against the Jews 1933-1945*, Bantam, New York 1976.
- De Jong, Louis, *Een sterfgeval te Auswitz*, Amsterdam 1970.
- Deuerlein, E., "Hitlers Eintritt in die Politik und die Reichswehr", in: *Vierteljahrshefte für Zeitgeschichte*, 1968, p. 204.
- *Die Vernichtungslager Majdanek und Treblinka*, Stern-Verlag, Vienna 1945.
- *Documents on German Foreign Policy 1918-1945*, Her Majesty's Stationery Office, London 1957.
- Donat, Alexander (ed.), *The Death Camp Treblinka*, Holocaust Library, New York 1979.
- Dötzer, Walter, *Entkeimung, Entwesung. Arbeitsanweisungen für Klinik und Laboratorium des Hygiene-Instituts der Waffen-SS*, Berlin, Urban and Schwarzenberg Publishers, Berlin and Vienna 1943.
- Dziadosz, Edward, Józef Marszałek, "Więzenia i obozy w dystrykcie lubelskim w latach 1939-1944", in: *Zeszyty Majdanka*, III, 1969.
- Ehrenburg, Ilja, Vassili Grossman, *Le Livre Noir. Textes et témoignages*, Actes Sudes, Arles 1995.
- *Enciclopedia Curcio di Scienza e Tecnica*, Curcio Editore, Rome 1973.
- *Enciclopedia Italiana*, Rome 1949.
- Engel, Štefan, Lev Haas, Bedřich Steiner, *Tragédia slovenských Židov: Fotografie a dokumenty*, Dokumentačná akcia pri ÚŠŽNO, Bratislava 1949.
- Epifanow, Alexander E., Hein Mayer, *Die Tragödie der deutschen Kriegsgefangenen in Stalingrad von 1942 bis 1956 nach russischen Archivunterlagen*, Biblio, Osnabrück 1996.
- Faurisson, Robert, "My Life as a Revisionist," *The Journal of Historical Review*, 9(1) 1989, pp. 5-63.

- Faurisson, Robert, “Katyn à Nuremberg”, in: *Revue d’Histoire Révisionniste*, No. 2, August-September-October 1990, pp. 138-144.
- Faurisson, Robert, *Ecrits révisionnistes (1974-1998)*, four volumes, private edition, Paris 1999.
- Faurisson, Robert, “How Many Deaths at Auschwitz?”, *The Revisionist*, 1(1) (2003), pp. 17-23.
- Faurisson, Robert, “Treblinka: An Exceptional Guide,” *The Revisionist*, 2(1) (2004), pp. 78-82.
- Feig, Konnilyn, *Hitler’s Death Camps: The Sanity of Madness*, Holmes and Meier Publishers, New York/London 1981.
- Flury, F., F. Zernik, *Schädliche Gase, Dämpfe, Nebel, Rauch- und Staubarten*, Verlag von Julius Springer, Berlin 1931.
- *France Soir*, July 4, 1945.
- Friedman, Filip, *This Was Oświęcim!*, The United Jewish Relief Appeal, London 1946.
- Friedman, Filip, *To jest Oświęcim!*, Krakow 1945.
- Friedman, P., *Roads to Extinction. Essays on the Holocaust*, The Jewish Publication Society of America, New York and Philadelphia 1980.
- Gauss, Ernst (ed.) (=Germar Rudolf), *Grundlagen zur Zeitgeschichte*, Grabert Verlag, Tübingen 1994.
- Gedenkstätte Terezin (ed.), *Das Ghetto Museum Theresienstadt*, undated.
- *Geiseln der Wehrmacht. Osaritschi, das Todeslager*, National Archive of the Republic of Belarus, Minsk 1999.
- Gerlach, Christian, *Kalkulierte Morde. Die deutsche Wirtschafts- und Vernichtungspolitik in Weißrußland*, Hamburger Edition, Hamburg 1999.
- Gilbert, Martin, *Atlas of the Holocaust*, William Morrow and Company, New York, 1993.
- Glatstein, Jacob, Israel Knox, Samuel Margoshes (eds.), *Anthology of Holocaust Literature*, Atheneum, New York 1968.
- Glazar, Richard, *Trap with a Green Fence*, Northwestern University Press, Evanston, IL, 1995.
- *Gli Ebrei nell’USSR*, Garzanti, Milan 1966.
- Główna Komisja Badania Zbrodni Hitlerowskich w Polsce (ed.), *Obozy Hitlerowskie na Ziemniach Polskich 1939-1945*. Informator encyclopedyczny, Warsaw 1979.
- Goshen, Seev, “Eichmann und die Nisko-Aktion im Oktober 1939”, in: *Vierteljahrshefte für Zeitgeschichte*, 1981.
- Graf, Jürgen, *The Giant with Feet of Clay: Raul Hilberg and His Standard Work on the “Holocaust”*, 2nd ed., Castle Hill Publishers, Uckfield 2015.
- Graf, Jürgen, Carlo Mattogno, *Concentration Camp Majdanek: A Historical and Technical Study*, reprint of 3rd ed., Castle Hill Publishers, Uckfield, 2016.
- Graf, Jürgen, Thomas Kues, Carlo Mattogno, *Sobibór: Holocaust Propaganda and Reality*, 2nd ed., Castle Hill Publishers, Uckfield 2020.
- Graf, Jürgen, Carlo Mattogno, *Concentration Camp Stutthof: Its History and Function in National Socialist Jewish Policy*, 4th ed., Castle Hill Publishers, Uckfield 2016.
- Gray, Martin, *Au nom de tous les miens*, Editions Robert Laffont, Paris 2001.
- Gray, Martin, *For Those I Loved*, Little, Brown, Boston 1972.
- Grossman, Vassili, *L’enfer de Treblinka*, B. Arthaud, Grenoble and Paris 1945.
- Grossmann, Wassili, *Piekło w Treblince*, Wydawnictwo Literatura Polska, Kattowitz 1945.
- Grossman, Wassili, *Die Hölle von Treblinka*, Publishers of Literature in foreign languages, Moscow 1946.
- Guérin, Dr., *Rawa Ruska*, Editions Oris, Paris 1945.
- Guillaume, Pierre, “Les bonnes intentions dont l’enfer est pavé”, in: *Annales d’Histoire Révisionniste*, No. 5, Summer/Fall 1988, pp. 189f.
- Gumkowski, J., A. Rutkowski, *Treblinka, Council for Protection of Fight and Martyrdom Monuments*, Warsaw, without date.
- Gutman, Israel (ed.), *Encyclopedia of the Holocaust*, 4 vols., Macmillan, New York 1990.
- Gutman, Israel, Michael Berenbaum (eds.), *Anatomy of the Auschwitz Death Camp*, Indiana University, Bloomington and Indianapolis 1994.

- Hilberg, Raul, *Sonderzüge nach Auschwitz*, Dumjahn, Munich 1981.
- Hilberg, Raul, *The Destruction of the European Jews*, 3 vols., Holmes & Meier, New York 1985.
- Höss, Rudolf, *The Commandant of Auschwitz*, Phoenix Press, London 2000.
- Huber, W., *Die Feuerbestattung – ein Postulat kultureller Entwicklung, und das St. Galler Krematorium*, self-published by the author, St. Gallen 1903.
- Igounet, Valérie, *Histoire du négationnisme en France*, Editions du Seuil, Paris 2000.
- IMT, *The Trial of the Major War Criminals before the International Military Tribunal*, Nuremberg, 14 November 1945–1 October 1946.
- Israel, State of, Ministry of Justice, *Criminal Case No. 373/86. State of Israel vs. Ivan (John) Demjanjuk*.
- Israel, State of, Ministry of Justice, *The Trial of Adolf Eichmann. Record of Proceedings in the District Court of Jerusalem*, Jerusalem 1993.
- *Israelitisches Wochenblatt für die Schweiz*, October 16, 1942.
- Jäckel, Eberhard, Jürgen Rohwer, *Der Mord an den Juden im Zweiten Weltkrieg*, Deutsche Verlags-Anstalt, Stuttgart 1985.
- Jäckel, Eberhard, Peter Longerich, Julius Schoeps (eds.), *Enzyklopädie des Holocausts. Die Verfolgung und Ermordung der europäischen Juden*, in three volumes, Argon Verlag, Berlin 1993.
- Jüdisches Historisches Institut Warschau (ed.), *Faschismus – Getto – Massenmord. Dokumentation über Ausrottung und Widerstand der Juden in Polen während der Zweiten Weltkriegs*, Röderberg-Verlag, Frankfurt/M. 1960.
- Kárný, Miroslav, *Terezínská pametní kniha: židovské oběti nacistických deportací z Čech a Moravy, 1941-1945*, Terezínská Iniciativa, Melantrich 1995; English: *idem, Terezín Memorial Book: Jewish Victims of Nazi Deportations from Bohemia and Moravia 1941-1945*, *ibid.*, 1996.
- Keeser, Eduard V. Froboese, R Turnan, *et al.*, *Toxikologie und Hygiene des Kraftfahrwesens*, Verlag von Julius Springer, Berlin 1930.
- Kehl, Horst, “‘Holocaust’ Pharmacology vs. Scientific Pharmacology”, in: *Journal of Historical Review*, 2 (1), Spring 1981, pp. 91-95.
- Kelber, G., “Un bourreau des camps nazis avoue: ‘J’ai exterminé jusqu’à 11,000 personnes par jour’”, *France Soir*, July 4, 1945, pp. 1f.
- Kempner, Robert, *Eichmann und Komplizen*, Europa Verlag, Zürich-Stuttgart-Vienna 1961.
- Kermisz, Józef, *Dokumenty i Materiały do dziejów okupacji niemieckiej w Polsce*, Vol. II: “*Akcje*” i “*Wysiedlenia*”, Warsaw-Lodz-Krakow 1946.
- Kielboń, Janina, “Deportacje Żydów do dystryktu lubelskiego (1939-1945)”, in: *Zeszyty Majdanka*, XIV, 1992.
- *KL Auschwitz. Fotografie dokumentalne*, Krajowa Agencja Wydawnicza, Warsaw 1980.
- Klarsfeld, Serge, *Mémorial de la Déportation des Juifs de France*, Paris 1979.
- Klarsfeld, Serge, Maxime Steinberg, *Mémorial de la Déportation des Juifs de Belgique*, The Beate Klarsfeld Foundation, New York 1994.
- Klee, Ernst, Willi Dreßen, Volker Reiß, *The Good Old Days*, Free Press, New York 1991.
- Klibanski, Brona, “Kinder aus dem Ghetto Białystok in Theresienstadt”, in: *Theresienstädter Studien und Dokumente*, Verlag Akademie, Prague 1995.
- Kogon, Eugen, *Der SS-Staat. Das System der deutschen Konzentrationslager*, Karl Alber Verlag, Munich 1946.
- Kogon, Eugen, *The Theory and Practice of Hell*, Secker & Warburg, London 1950.
- Kogon, Eugen, Hermann Langbein, Adalbert Rückerl (eds.), *Nazi Mass Murder*, Yale University Press, New Haven 1993.
- Kopanski, Atallah B., “North Caucasia’s Anno Horribilis, 1944,” *The Barnes Review*, 4(4) (1998), pp. 37-40.
- Krausnick, Helmut, Hans-Heinrich Wilhelm, *Die Truppe des Weltanschauungskrieges*, DVA, Stuttgart 1981.

- *Kronika Getta łódzkiego*, Wydawnictwo łódzkie, Łódź 1965.
- Kues, Thomas, “Chil Rajchman’s Treblinka Memoirs,” *Inconvenient History*, Vol. 2, No. 1, 2010; www.inconvenienthistory.com/2/1/1916
- Kues, Thomas, “UK Forensic Archeologist Sets Out To Refute Treblinka ‘Deniers,’” 13 Nov. 2010; <http://revblog.codoh.com/2010/11/uk-forensic-archeologist-sets-out-to-refute-treblinka-deniers/>
- Krugłów, Aleksander, “Deportacja ludności żydowskiej z dystryktu Galicja do obozu zagłady w Belzcu”, in: *Biuletyn Żydowskiego Instytutu Historycznego w Polsce*, No. 3, 1989.
- Kulischer, Eugene M., *The Displacement of Population in Europe*. Published by the International Labour Office, Montreal 1943.
- *L’Esprit*, September 1980.
- Lanzmann, Claude, *Shoa*, Editions Fayard, Paris 1985.
- Lanzmann, Claude, *Shoah*, DaCapo Press, New York 1995.
- Lehner, Dieter, *Du sollst nicht falsch Zeugnis geben*, Vowinckel, Berg undated [1988].
- *Le Journal du Dimanche*, March 30, 1986.
- *Le Monde*, May 2, 1966.
- *Lemberger Zeitung*, July 9, 1942; October 17, 1942.
- Lenz, Otto, Ludwig Gassner, *Schädlingsbekämpfung mit hochgiftigen Stoffen*, Publishing House of Richard Schoetz, Berlin 1934.
- Leszczyńska, Zofia, “Transporty więźniów do obozu w Majdanku”, in: *Zeszyty Majdanka*, IV, 1969.
- Lichtenstein, Heiner, *Mit der Reichsbahn in den Tod*, Bud-Verlag, Düsseldorf 1985.
- “Likwidacja Getta Warszawskiego”, in: *Biuletyn Żydowskiego Instytutu Historycznego w Polsce*, Warsaw, January-July 1951, No. 1, pp. 59-126.
- Łukaszkiewicz, Zdzisław, *Obóz straceń w Treblince*, Państwowy Instytut Wydawniczy, Warsaw 1946.
- Łukaszkiewicz, Zdzisław, “Obóz zagłady Treblinka”, in: *Biuletyn Głównej Komisji Badania Zbrodni Hitlerowskich w Polsce*, I, 1946, pp. 133-144.
- Łukaszkiewicz, Zdzisław, “Obóz pracy w Treblince”, in: *Biuletyn Głównej Komisji Badania Zbrodni Niemieckich w Polsce*, III, 1947.
- Maccone, Luigi, *Storia documentata della cremazione presso i popoli antichi ed i moderni con particolare riferimento all’igiene*, Istituto Italiano d’Arti Grafiche, Bergamo 1932.
- Marczevska, Krystyna, Władysław Ważniewski, “Treblinka w świetle Akt Delegatury Rządu RP na Kraj”, in: *Biuletyn Głównej Komisji Badania Zbrodni Hitlerowskich w Polsce*, XIX, Warsaw 1968, pp. 129-164.
- Marszałek, Józef, “Rozpoznanie obozów śmierci w Belzcu, Sobiborze e Treblince przez wywiad Armii Krajowej i Delegatury Rządu Rzeczypospolitej Polskiej na Kraj”, in: *Biuletyn Głównej Komisji Badania Zbrodni przeciwko narodowi polskiemu Instytutu Pamięci Narodowej*, Vol. XXXV, Warsaw 1993.
- “Mass Graves at Nazi Death Camp Treblinka Prove Holocaust Deniers Wrong,” *Huffington Post*, UK, 16 Jan. 2012; http://www.huffingtonpost.co.uk/2012/01/16/mass-graves-at-nazi-death-camp-treblinka-holocaust_n_1208814.html
- Mattogno, Carlo, *Il rapporto Gerstein: Anatomia di un falso*, Sentinella d’Italia, Monfalcone 1985.
- Mattogno, Carlo, “Sonderbehandlung” *ad Auschwitz: Genesi e Significato*, Edizioni di Ar, Padua 2001.
- Mattogno, Carlo, “Auschwitz. The new Revisions by Fritjof Meyer,” *The Revisionist*, 1(1) (2003), pp. 30-37.
- Mattogno, Carlo, *Belzec: Propaganda, Testimonies, Archeological Research, and History*, Theses & Dissertations Press, Chicago 2004 (reprint Castle Hill Publishers, Uckfield 2016).
- Mattogno, Carlo, “Combustion Experiments with Flesh and Animal Fat”, *The Revisionist* 2(1) (2004), pp. 64-72.

- Mattogno, Carlo, “Belzec or the Holocaust Controversy of Roberto Muehlenkamp,” Section 4.1.; January 2009; <https://codoh.com/library/document/975/>
- Mattogno, Carlo, *The Central Construction Office of the Waffen-SS and Police Auschwitz: Organization, Responsibilities, Activities*, 2nd ed., Castle Hill Publishers, Uckfield 2015.
- Mattogno, Carlo, *Special Treatment in Auschwitz*, 2nd ed., Castle Hill Publishers, Uckfield, 2016.
- Mattogno, Carlo, *The Einsatzgruppen in the Occupied Eastern Territories: Genesis, Missions and Actions*, Castle Hill Publishers, Uckfield 2018.
- Mayer, Arno, *Why Did the Heavens Not Darken? The “Final Solution” in History*, Pantheon Books, New York 1988.
- Mencil, Tadeusz (ed.), *Majdanek 1941-1944*, Wydawnictwo Lubelskie, Lublin 1991.
- Meyer, Fritjof, “Die Zahl der Opfer von Auschwitz. Neue Erkenntnisse durch neue Archivfunde”, *Osteuropa. Zeitschrift für Gegenwartsfragen des Ostens*, No. 5, May 2002, pp. 631-641.
- Morsch, Günter, Betrand Perz (eds.), *Neue Studien zu nationalsozialistischen Massentötungen durch Giftgas. Historische Bedeutung, technische Entwicklung, revisionistische Leugnung*, Metropol, Berlin 2011.
- Paget, Reginald, *Manstein. His Campaigns and His Trial*, Collins, London 1951.
- Pauly, M., *Die Feuerbestattung*, Leipzig 1904.
- Phelps, R.H., “Hitlers ‘grundlegende’ Rede über den Antisemitismus”, in: *Vierteljahrshefte für Zeitgeschichte*, 1968, p. 417.
- Picciotto-Fargion, Liliana, *Il libro della memoria. Gli Ebrei deportati dall’Italia (1943-1945)*, Mursia, Milano 1995.
- Picker, Henry, *Hitlers Tischgespräche im Führerhauptquartier*, Wilhelm Goldmann Verlag, Munich 1981.
- Pini, G., *La crémation en Italie à l’étranger*, Ulrico Hoepli editore, Milan 1885.
- Poliakov, Léon, *Harvest of Hate*, Holocaust Library, New York 1979.
- Poliakov, Léon, Josef Wulf, *Das Dritte Reich und die Juden. Dokumente und Aufsätze*, Arani Verlag, Berlin-Grunewald 1955.
- *Polish Charges against German War Criminals*. Submitted to the United Nations War Crimes Commission by Dr. Marian Muszkat, Warsaw 1948.
- Pressac, Jean-Claude, *Die Krematorien von Auschwitz. Die Technik des Massenmordes*, Piper Verlag, Munich/Zürich 1994.
- Pressac, Jean-Claude, “Enquête sur les camps de la mort”, in: *Historama*, No. 34, 1995.
- Raisky, Adam, *Le presse antiraciste sous l’occupation hitlérienne*, Paris 1950.
- Rajca, Czesław, “Problem liczby ofiar w obozie na Majdanku”, in: *Zeszyty Majdanka*, Vol. XIV, 1992.
- Rajchman, Chil, *Treblinka: A Survivor’s Memory 1942–1943*, MacLehose Press, London 2011
- Rapoport, Louis, *La guerra di Stalin contro gli ebrei*, Rizzoli, Milan 1991.
- *Rassegna Sovietica*, August-September 1951.
- Rassinier, Paul, *Le Drame des Juifs Européens*, Les Sept Couleurs, Paris 1964.
- Reitlinger, Gerald, *The Final Solution. The Attempt to Exterminate the Jews of Europe 1939-1945*, Vallentine, Mitchell, London 1953.
- Reitlinger, Gerald, *The Final Solution. Hitler’s Attempt to Exterminate the Jews of Europe 1939-1945*, 3rd ed., J. Aronson, Northvale, N.J., 1987.
- *Riešenie židovskej otázky na Slovensku (1939-1945). Dokumenty*, Edícia Judaica Slovaca, Bratislava 1994.
- Ringelblum, Emmanuel, *Kronika Getta Warszawskiego*, Artur Eisenbach, (ed.), Czytelnik, Warsaw 1983.
- Ruckerl, Adalbert, *NS-Prozesse*, Verlag C. F. Müller, Karlsruhe 1971.
- Ruckerl, Adalbert, *NS-Vernichtungslager im Spiegel deutscher Strafprozesse*, Deutscher Taschenbuch-Verlag, Frankfurt 1977.

- Rudolf, Germar, “Cautious Mainstream Revisionism”, *The Revisionist*, 1(1) (2003), pp. 23-30.
- Rudolf, Germar (ed.), *Dissecting the Holocaust: The Growing Critique of “Truth” and “Memory,”* 3rd ed., Castle Hill Publishers, Uckfield, 2019.
- Rudolf, Germar (ed.), *Air-Photo Evidence*, 6th ed., Castle Hill Publishers, Uckfield 2020.
- Rullmann, Hans Peter, *Der Fall Demjanjuk: Unschuldiger oder Massenmörder?*, Verlag für ganzheitliche Forschung und Kultur, Viöl 1987.
- Russell, Lord of Liverpool, *The Scourge of the Swastika*, Cassell & Company Ltd., London 1954.
- Rüter, C. F., et al. (eds.), *Justiz und NS-Verbrechen. Sammlung deutscher Strafurteile wegen nationalsozialistischer Tötungsverbrechen 1945-1966*, Amsterdam 1968-1971.
- Sandkühler, Thomas, *Endlösung in Galizien. Der Judenmord in Ostpolen und die Rettungsinitiativen von Berthold Beitz 1941-1944*, Verlag H.J.V. Dietz Successors, Bonn 1996.
- Sanning, Walter, *The Dissolution of Eastern European Jewry*, Institute for Historical Review, Torrance 1983 (2nd ed., Castle Hill Publishers, Uckfield 2015).
- Schelvis, Jules, *Vernichtungslager Sobibor*, Metropol Verlag, Berlin 1998.
- Sereny, Gitta, *Into That Darkness*, McGraw-Hill, New York 1974.
- Sereny, Gitta, “The Men Who Whitewash Hitler,” *New Statesman*, November 2, 1979.
- Sereny, Gitta, *Am Abgrund*, Piper, Munich 1995.
- Sheftel, Yoram, *Defending ‘Ivan the Terrible’. The Conspiracy to Convict John Demjanjuk*, Regnery Publishing, Washington 1996.
- Silberschein, A., *Die Judenausrottung in Polen*, Geneva 1944.
- Smith, Bradley F., Agnes Peterson (eds.), *Heinrich Himmler. Geheimreden 1933 bis 1945*, Propyläen Verlag, Frankfurt/M. 1974.
- Smith, Bradley R., “Abraham Bomba, the Barber of Treblinka”, in: *The Revisionist*, 1(2) (2003), pp. 170-176.
- Steiner, Jean-François, *Treblinka*, Librairie Arthème Fayard, Paris 1966.
- Steiner, Jean-François, *Treblinka*, Simon and Schuster, New York 1967.
- Sturdy Colls, Caroline, “Gone but not Forgotten: Archaeological approaches to the site of the former Treblinka Extermination Camp in Poland,” *Holocaust Studies and Materials* (English edition), 3 (2013), pp. 253-289.
- Sturdy Colls, Caroline, *Holocaust Archaeologies: Approaches and Future Directions*, Springer, Cham, 2015.
- Sturdy Colls, Caroline, “Une cartographie de la terreur nazie: études archéologiques dans les camps de travail et d’extermination de Treblinka,” in: Jean Guilaine, Jacques Sémelin (eds.), *Violences de guerre, violences de masse*, La Découverte, Paris 2016.
- Sturdy Colls, Caroline, Michael Branthwaite, “‘This is Proof’? Forensic Evidence and Ambiguous Material Culture at Treblinka Extermination Camp,” *International Journal of Historical Archaeology*, 22(2) (2018), pp. 430-453.
- Sturdy Colls, Caroline, “Unearthing Treblinka?: Archaeological Investigations at Treblinka Extermination and Labour Camps.” In: Vareka, P. and Symonds, J. *Dark Modernities*, Palgrave Macmillan, Basingstoke 2018 (In Press – really?).
- Szajn-Lewin, Eugenia, *Aufzeichnungen aus dem Warschauer Ghetto*, Reclam Verlag, Leipzig 1994.
- Terlecki, Tymon, *Wiadomosci Polskie*, No. 45, November 7, 1943.
- *The New York Times*, August 8, 1943, p. 11.
- Tóth, Dezider, Ministerstvo Kultúry Slovenskej Republiky, Múzeum Slovenského Národného Povstania (eds.), *Tragédia slovenských Židov: Materiály z medzinár. sympózia*, Datei, Banská Bystrica 1992.
- “Treblinka: Revealing the Hidden Graves of the Holocaust,” *BBC Magazine*, 23 Jan. 2012; www.bbc.co.uk/news/magazine-16657363
- Tregenza, Michael, “Christian Wirth. Inspekteur der SS-Sonderkommandos ‘Aktion Reinhard’,” in: *Zeszyty Majdanka*, Vol. XV, 1993.
- Tschernoglasnova, Raissa A., *Tragedia Evreev Belorussi v 1941-1944 gd.*, Minsk 1997.

- Tyszkowa, Maria, “Eksternacja Żydów w latach 1941-1943. Dokumenty Biura Informacji i Propagandy KG AK w zbiorach oddziału rękopisów buw”, in: *Biuletyn Żydowskiego Instytutu Historycznego w Polsce*, No. 4 (1964), Warsaw.
- Union des juifs pour la résistance et l’entraide (ed.), *La presse antiraciste sous l’occupation hitlérienne*, self-published, Paris 1950.
- Vidal-Naquet, Pierre, “Treblinka et l’Honneur des Juifs,” *Le Monde*, May 2, 1966.
- Vidal-Naquet, Pierre, *Esprit*, September 1980.
- *Vierteljahreshefte für freie Geschichtsforschung*, 1(2) (1997), p. 126; 2(4) (1998), p. 327; 6(2) (2002), p. 239.
- Vilnius Ghetto: *List of Prisoners, Volume 1*, Lietuvos valstybinis zydu muziejus, Vilnius 1996.
- Vogel, R., *Ein Stempel hat gefehlt. Dokumente zur Emigration deutscher Juden*, Droemer Knaur, Munich/Zürich 1977.
- Walendy, Udo, *Historische Tatsachen*, No. 12: “Das Recht, in dem wir leben”, Verlags für Volkstum und Zeitgeschichtsforschung, Vlotho 1982.
- Walendy, Udo, *Historische Tatsachen*, No. 16: “Einsatzgruppen in Verbände des Heeres, Teil 1”, Verlags für Volkstum und Zeitgeschichtsforschung, Vlotho 1983.
- Walendy, Udo, *Historische Tatsachen*, No. 44: “Der Fall Treblinka”, Verlags für Volkstum und Zeitgeschichtsforschung, Vlotho 1990.
- Walendy, Udo, *Historische Tatsachen*, No. 51: “Babi Jar. Die Schlucht ‘mit 33,771 ermordeten Juden’?”, Verlags für Volkstum und Zeitgeschichtsforschung, Vlotho 1992.
- Weber, Mark, Andrew Allen “Treblinka”, in: *Journal of Historical Review*, 12(2) 1992, pp. 133-158.
- Weissmandel, Dov, *Min-hammetsar*, Emunah, New York 1960.
- Weliczker, Leon, *Brygada śmierci*, Lodz 1946.
- Wellers, Georges, *La Solution Finale et la Mythomanie Néo-Nazie*, ed. by Beata and Serge Klarsfeld, Paris 1979.
- Wellers, Georges, “Encore sur le Témoignage Gerstein”, in: *Le Monde Juif*, January-March 1980, No. 97, p. 28.
- Wiernik, Yankel, *A Year in Treblinka*, published by American Representation of the General Jewish Workers’ Union of Poland, New York 1944; www.zchor.org/treblink/wiernik.htm.
- Willenberg, Samuel, *Revolt in Treblinka*, Żydowski Instytut Historyczny, Warsaw 1989.
- Willenberg, Samuel, *Surviving Treblinka*, Basil Blackwell, Oxford/New York 1989.
- Witte, Peter, “Zwei Entscheidungen in der ‘Endlösung der Judenfrage’. Deportation nach Lodz und Vernichtung in Chełmno”, in: *Theresienstädter Studien und Dokumente*, Verlag Akademie, Prague 1995.
- Wojtczak, Stanisław, “Karny obóz pracy Treblinka I i ośrodek zagłady Treblinka II”, in: *Biuletyn Głównej Komisji Badania Zbrodni Hitlerowskich w Polsce*, XXVI, Warsaw 1975, pp. 117-185.
- Wydawnictwo Centralnej Żydowskiej Komisji Historycznej (ed.), *Dokumenty i Materiały*, revised by N. Blumental, Lodz 1946.
- Zander, Friedrich, *Die Verbreitung der Juden in der Welt*, Robert Kämmerer Verlag, Berlin 1937.
- Zylbersztajn, Samuel, “Pamiętnik więźnia dziesięciu obozów”, in: *Biuletyn Żydowskiego Instytutu Historycznego w Polsce*, No. 68 (1968).

Index of Names

Individuals only. Page numbers of entries in footnotes as italics.

— A —

- Abate, Dante: 324
 Abetz, Otto: 184
 Adam, Uwe Dietrich: 102
 Adametz, Gerhard: 228
 Ahnert, Horst: 250, 251
 Akhmetov, Abdul: 294
 Allen, Andrew: 45, *173*,
277
 Alter, Marek: 238
 Anyszkiewicz,
 Mieczysław: 77
 Apenszlak, Jacob: *51*
 Apresian, V.S.: 77
 Arad, Yitzhak: 36, 37, 57,
 62, 63, 90, 102-105, 108,
 114, 125, 126, 131, *137*,
 140, 141, *142*, 145, 147,
 150, 155, 157, 158, 265,
 279, 299, 311, *317*, 320
 Ariel, Shimon: 227
 Arndt, Ino: 101
 Auerbach, Rachel: 23-26,
 32, 33, 37, 38, 67, 73,
 82, 83, 89, 98, *132*, 135,
 290
 Auerswald, Heinz: 115
 Aynat, Enrique: *245*, *249*
- ### — B —
- Ball, John Clive: 42, 43,
 90, 137, 221, 222, 288,
 356, 357
 Baranowski, Julian: 296
 Barry (Dog): 168, 169
 Bartsch, Martin: *173*
 Bay, Alex: 321, 322
 Beitz, Berthold: 225
 Benz, Wolfgang: 37, 38,
 123, *199*, *201*, *233*, *244*,
 293
 Berenbaum, Michael: *142*
 Berenstein, Tatjana: *263*,
 284, 285, 287, 309
- Berg, Friedrich Paul: 42,
 43, 45, 73, 121-123, 132,
173, 306
 Berger, Oskar: 50
 Bielfeld: 190
 Bigan: 51
 Bilitz, Alfred: 27
 Blacherski, Zygmunt: 27
 Blank, Manfred: 155
 Blatt, Thomas (Tovi): 258
 Blobel, Paul: 142, 226,
 228, 229
 Blumental, Nachman: 26,
 94, 339, 340
 Bohlinger, Roland: *187*
 Boisdefeu, Jean-Marie:
 257, 261
 Bomba, Abraham: 35, 301
 Borowy, Stanisław: 155
 Branthwaite, Michael: 324
 Brechtken, Magnus: *181*
 Brenner, Hejnoch: 25, 27,
 79, 153
 Broszat, Martin: *112*, 163,
185
 Browning, Christopher R:
 230
 Buchheim, Hans: *112*
 Burba, Manfred: 103, 104,
 338
 Butz, Arthur R.: 45, 161,
 204
 Byk, Jakob: 83
- ### — C —
- Carnier, Pier Arrigo: *305*
 Carter, Jimmy: 173
 Charles, Jonathan: 311,
 314
 Chelain, André: *41*
 Chernoglazova, Raisa A.:
199, *215*
 Chklovski, Viktor: 257
- Chodzko, Mieczysław: 81,
 292
 Cohen, Elias Alex: 259
 Cohen, Shalom: 33
 Colombo, G.: *138*, *151*
 Conan, Eric: 30
 Cukerman, family: 213
 Cukowa, Lucian: 21
 Cyprian, Tadeusz: 62
 Czarkowski, Ryszard: 36,
 37, 70, 104, 105, 140
 Czech, Danuta: *142*, 288
 Czechowicz, Aron: 25, 117
- ### — D —
- Daeningckx, Didier: 29
 Daluege, Kurt: 186
 Danilchenko: 172
 Dannecker, Theodor: 247-
 249
 Darlan, François: 184
 Davidov, Vladimir K.:
 220, 221, 227
 Dawidowicz, Lucy: 277
 de Beauvoir, Simone: 27,
 34
 De Jong, Louis: *127*
 Demjanjuk, Ivan (John):
 25, 27, 34, 75, 169-175,
 284
 Deuerlein, E.: *179*
 Donat, Alexander: *10*, 23,
 32, 33, 67, 69, 70, *71*,
 73, 75, 83, 96, *135*, 147,
151, *154*, *155*, 156, 290
 Dorner, Dalia: 169
 Dötzer, Walter: 290, 292
 Dragan, Miroslav: 16, *169*,
 284
 Dreßen, Willi: *140*
 Dziadosz, Edward: 260

— E —

Eberl, Irmfried: 13, 115, 320
 Edelman, Zalma: 227
 Egorov, K.: 81
 Ehrenburg, Ilya: 19, 221, 222, 227, 228, 257, 262
 Ehrlinger, Erich: 196
 Eichmann, Adolf: 72, 75, 127, 131, 183, 186, 200, 233, 247-249, 251
 Eisenbach, Arthur: 50
 Eitan, Dov: 174
 Eliazar, Judith: 259
 Engel, Štefan: 246
 Epifanow, Alexander E.: 307
 Epstein, Pinchas: 169
 Evenson, Moissei Samoilowitsch: 257

— F —

Farber, Y: 228
 Faurisson, Robert: 16, 27, 29, 30, 35, 45, 299, 300, 309
 Feig, Konnilyn G.: 145-147
 Finkelsztejn, Leon: 25, 27, 117, 171
 Fleischmann, Gisi: 251, 266
 Floss, Herbert: 28, 145, 146, 147
 Flury, F.: 133
 Foxman, Abraham: 213
 Frank, Hans: 61, 181, 185, 186, 277
 Franz, Kurt: 116, 140, 145, 162, 164, 168, 169, 322, see also Lalka
 Freud, Sigmund: 79
 Friedman, Filip: 72
 Friedman, P.: 261
 Friedman, Szimon: 82
 Frischmann, Josef: 260
 Froboese, V: 123

— G —

Gaffa: 210
 Gallo, Max: 30

Ganzenmüller, Albert: 275
 Gassner, Ludwig: 129
 Gauss, Ernst: 42, 45, 187
 Gemlich, Adolf: 179
 Gens, Adolf: 27
 Gens, Jacob: 213
 Gerlach, Christian: 143, 199, 225, 260, 261, 277, 288
 Gerstein, Kurt: 41, 42, 51, 74-76, 125-131, 132, 292
 Gilbert, Martin: 103, 105
 Glatstein, Jacob: 213
 Glazar, Richard: 38, 39, 151
 Globocnik, Odilo: 113, 125, 129, 131, 236, 280, 305, 306
 Goebbels, Josef: 182, 185
 Gold, Arthur: 61
 Goldberg, Szymon: 26, 66
 Goldfarb, Abraham: 34
 Golovan, M.E.: 77
 Goshen, Seev: 233
 Grabarz, Georg: 72, 132, 347
 Graf, Jürgen: 2, 16, 107, 108, 112, 129, 143, 156, 164, 215, 292, 300, 304, 308, 309, 316
 Gray, Martin: 29, 30
 Greiser, Arthur: 194, 254
 Grinberg, Tanhum: 33, 82
 Gross, E: 123
 Grossmann, Vassili: 11, 19, 20, 23, 26, 33, 44, 66, 96, 118, 153, 221, 222, 227, 228, 257, 262
 Guérin, Dr.: 261
 Guilaine, Jean: 324
 Guillaume, Pierre: 31
 Gumkowski, J.: 37, 89, 156, 159
 Günther, Rolf: 127, 128, 249
 Gutman, Israel: 11, 142

— H —

Haas, Lev: 246
 Hanusiak, Michael: 172

Harster, Wilhelm: 252
 Hertz, I: 261
 Heydrich, Reinhardt: 9, 161, 179, 180-183, 185, 187, 188, 190, 191, 194, 196, 229, 233, 279
 Hilberg, Raul: 11, 107, 111, 112, 164, 199, 203, 204, 223, 257, 275, 278, 280, 281, 300
 Himmler, Heinrich: 15, 25, 79, 106, 130, 131, 141-146, 186, 194, 204, 225, 226, 248, 250, 254-256, 258, 259, 275, 279
 Hitler, Adolf: 20, 32, 33, 37, 74, 76, 91, 130, 145, 161, 179, 185, 186, 188, 189, 194, 204, 230, 268, 269, 288, 294
 Höfle, Hermann: 236, 317, 320
 Hoppe, Paul: 216
 Horn, Max: 280
 Horn, Otto: 118
 Horonschitzki, Dr: 67
 Höss, Rudolf: 126, 228
 Huber, W.: 150

— I —

Igounet, Valérie: 40, 107
 Irving, David: 185
 Itzhaki, Solomon: 294

— J —

Jäckel, Eberhard: 42, 111, 203, 305
 Jacobsen, Hans-Adolf: 112
 Janetzke, Wilhelm: 198
 Jansen-Ensel, Bertha: 259
 Jurowski: 67, 77, 119-121, 136, 344, 345

— K —

Kacew, family: 212
 Kadalo, N.V.: 77
 Kaindl, Anton: 158
 Kállay, Miklós: 255
 Kann, Tadeusz: 77
 Kárný, Miroslav: 200, 231

- Katzmann, Fritz: 113, 264-266
 Keeser, E.: 123
 Kehl, Horst: 33
 Keitel, Wilhelm: 196
 Kelber, G.: 128
 Kempner, Robert: 186, 200
 Kermisz, Józef: 82, 234, 239, 240, 258
 Kielboń, Janina: 233, 242
 Klarsfeld, Beate: 158, 252
 Klarsfeld, Serge: 158, 252, 269
 Klee, Ernst: 140
 Klibanski, Brona: 287
 Knox, Israel: 213
 Kobus, Marianna: 77
 Koch, Erich: 195
 Koeppen, Werner: 185
 Kogon, Eugen: 33, 34, 50, 142
 Köhler, Manfred: 308
 Kola, Andrzej: 311, 315-317, 319, 321
 Kon, Abe: 25, 64, 79, 97, 118, 119, 153, 155
 Kon, Stainslaw: 25, 67, 77, 141, 155
 Kononyuk: 77
 Kopanski, Atallah B.: 308
 Koppe, Wilhelm: 194
 Korherr, Richard: 106, 193, 201, 210, 244, 269, 296
 Kosak, Stanisław: see Kozak, Stanisław
 Kozak, Stanisław: 289, 290
 Krausnick, Helmut: 100, 101, 112, 165, 226, 227, 257
 Krege, Richard: 16
 Krüger, Friedrich
 Wilhelm: 116, 266, 279
 Krugłow, Aleksander: 264, 265
 Krym, Stanisław: 79
 Krzepicki, Abraham: 10, 32
 Kube, Wilhelm: 198, 278, 348
 Kucharek: 87
 Kudlik, Aleksander (Arie): 25, 94, 141, 333, 339
 Kues, Thomas: 2, 307, 311, 316
 Kulischer, Eugene M: 267-272, 276, 277, 295
 Kusevitski, Michail: 294
 Kuss, E: 123
 — L —
 Laks, Moszek: 94, 95, 139, 340
 Lalka (Kurt Franz): 29, 140, 145
 Lammers, Hans Heinrich: 189
 Lampert, Erwin: 27
 Langbein, Hermann: 33
 Lanzmann, Claude: 34, 35, 301
 Laponder, Peter: 322
 Lavrenko: 220
 Ledecke: 21
 Lefler, SS man: 170
 Lehner, Dieter: 173
 Leib: 20
 Leibbrandt, Georg: 197, 254
 Lenk: 240
 Lenz, Otto: 129
 Leszczyńska, Zofia: 285, 287
 Leszczyński, Jakob: 134
 Levakov, G.E.: 81
 Levin, Dov: 169
 Lewit, Maks: 20, 77
 Lichtenstein, Heiner: 199
 Lohse, Hinrich: 195-198, 231, 254, 278, 348, 349
 Longerich, Peter: 42
 Lopuszyński: 87
 Łukasziewicz, Zdzisław: 25, 26, 33, 37, 66, 67, 74, 82, 83, 84, 86-92, 96, 98, 102, 103, 105, 113-115, 117, 118, 141, 143, 150, 151, 153, 155, 286, 287, 335, 336
 Luther, Martin: 189, 190, 191, 225, 246
 — M —
 Maccone, Luigi: 139
 Maciejewski, J.: 82, 85, 86
 Maedel, Walter: 192
 Maglione, Cardinal Luigi: 255, 256
 Marchenko, Ivan: 174
 Marczevska, Krystyna: 29, 33, 47, 48, 51, 62, 278, 328
 Margoshes, Samuel: 213
 Markov, Marko A.: 218
 Marszałek, Józef: 63, 260
 Mattei: 130
 Mattogno, Carlo: 2, 16, 41, 42, 51, 107, 108, 112, 114, 129, 143, 148, 156, 215, 221, 245, 249, 292, 300, 304, 305, 308, 309, 316, 317, 319, 351-355
 Mayer, Arno: 207
 Mayer, Hein: 307
 McMahon, Patrick: 228
 Mencil, Tadeusz: 284, 286, 287
 Merkevicus, Algimantas: 224
 Meyer, Fritjof: 300, 303-309
 Michalowski, family: 212
 Miete: 38
 Mitte: 38
 Mittelberg, M.: 82
 Morsch, Günter: 320
 Mulka, Robert: 165
 Müller, Heinrich: 142, 225, 229
 Muszkat, Marian: 26
 — N —
 Nacht, Naftali: 261
 Nebe, Arthur: 194
 Neufeldt, Berthold: 231
 Neumaier, Arnulf: 16, 42, 45, 91, 136, 146, 148, 334
 Ney, Johannes P.: 187
 Nikolai: 34
 Nolte, Hans-Heinrich: 218
 Nowak, Franz: 249

— O —

Oberg, Carl-Albrecht: 113
 Oberhauser, Josef: 129,
 164, 165
 Ohlendorf, Otto: 203, 204,
 211

— P —

Paget, Reginald T.: 210
 Pauly, Max: 139
 Perrault, Gilles: 27
 Perz, Betrand: 320
 Peterson, Agnes: 255
 Pfannenstiel, Wilhelm:
 126, 128, 307
 Phelps, R.H.: 179
 Picciotto-Fargion, Liliana:
 305
 Picker, Henry: 189
 Pini, G.: 149
 Piotrowski, Mieczysław:
 88, 137
 Piper, Franciszek: 142
 Platkiewicz, Maniek: 94,
 95, 139
 Pohl, Dieter: 320
 Pohl, Oswald: 157, 158,
 239, 250, 258
 Polak, Cato: 259
 Poliakov, Léon: 75, 76,
 134, 280
 Poswolski, Henryk: 25,
 141
 Preifi: 21
 Pressac, Jean-Claude: 40,
 107, 108, 156, 289, 290,
 300
 Puchała, Lucjan: 77, 79,
 113, 114
 Pukaszek, Józef: 77

— R —

Rabinowicz, Jakub: 51
 Rademacher, Franz: 180,
 181, 186, 188, 190, 248
 Rajca, Czesław: 159
 Rajchman, Chil: 316, 317
 Rajzman, Samuel: 26, 33,
 42, 67-69, 72, 77, 79, 82,
 85, 89, 96, 97, 139, 141,

153, 155, 157, 158, 160,
 292
 Rapoport, Louis: 295, 296
 Rasch: 194
 Rasch, Otto: 228, 229, 253
 Rassinier, Paul: 41
 Reichmann, Henryk
 (Yehiel): 25, 66, 117,
 148, 153, 171
 Reinhardt, Fritz: 9
 Reitlinger, Gerald: 74, 76,
 107, 156, 165, 193, 209,
 210, 227, 279, 280, 286,
 292, 294, 295, 296
 Reuter, Fritz: 235
 Ribbentrop, Joachim: 180,
 182
 Richter: 218
 Rieß, Volker: 140
 Ringelblum, Emmanuel:
 50, 63
 Ritter, G.: 123
 Rodionov, F.A.: 77
 Rohwer, Jürgen: 111, 203,
 305
 Roiter, Howard: 69
 Romanowski: 87
 Roques, Henri: 41
 Rosenberg, Alfred: 181,
 182, 184-186, 189, 194,
 196-198, 205, 206, 233,
 254
 Rosenberg, Eliyahu
 (Eliahu, Elias): 75, 119,
 136, 138, 170, 173, 174,
 316, 317
 Roser, Paul: 261
 Rückerl, Adalbert: 32, 33,
 34, 92, 99, 100, 101,
 106, 116, 129, 137, 146,
 155, 162-165, 167, 168,
 169, 225, 285, 290
 Rudolf, Germar: 38, 42,
 43, 45, 91, 108, 137,
 211, 221, 222, 293, 296,
 300, 305, 308, 334, 356,
 357
 Rullmann, Hans Peter: 75,
 171, 172, 173
 Russell, Lord of Liverpool:
 76

Rüter, C.F.: 129
 Rutkowski, Adam: 37, 89,
 156, 159, 284, 285, 287

— S —

Sandkühler, Thomas: 225,
 227, 228, 265
 Sanning, Walter: 37, 38,
 293
 Sauer: 54, 59, 60
 Scheffler, Wolfgang: 101,
 106, 165
 Schelvis, Jules: 259, 260
 Schimelevitsch, family:
 213
 Schleunes, K. A.: 305
 Schoeps, Julius: 42
 Schulz, Erwin: 228
 Schwarz: 21
 Selmi, F: 139
 Sémelin, Jacques: 324
 Sereny, Gitta: 30, 31, 140,
 161
 Shandruk, General: 172
 Sheftel, Yoram: 171, 172,
 174
 Shelaiev, Nikolai: 174
 Sher, Neil: 173
 Sidor, Karol: 255
 Siegert: 231
 Silberschein, A.: 57, 58,
 290-292, 329
 Simonov, Konstantin: 19
 Skarzyński, Kazimierz: 21,
 65, 77, 79, 152
 Słebczak, J.: 82
 Smirnov, L.N.: 73-75, 218,
 228
 Smith, Bradley F.: 255
 Smith, Bradley R.: 301
 Sobolevski, P.: 81
 Sourez: 79
 Speer, Albert: 112, 113,
 250
 Spieß, A.: 94, 338
 Stahlecker, Franz: 196,
 197, 209, 210
 Stalin, Josef: 20, 295
 Stamleriene, Chana: 212
 Stangl, Franz: 13, 30, 31,
 161, 162, 320

Steinberg, Maxime: 252
 Steiner, Bedřich: 246
 Steiner, Jean-François: 27-30, 146
 Strauch, R.R.: 204
 Strawczyński, Oskar: 25
 Strebel: 79, 92
 Streim, Alfred: 203, 225
 Stroop, Jürgen (also Report): 100, 101, 275, 279-284
 Sturdy Colls, Caroline: 307, 311-324
 Sułkowski, Jan: 27, 105
 Swiderski: 20
 Symonds, J.: 323
 Szajn-Lewin, Eugenia: 51

— T —

Taigman, Kalman: 311
 Tal, Zvi A: 169
 Terlecki, Tymon: 61
 Tiedemann, Herbert: 211
 Tóth, Dezider: 246
 Trautsolt, K.: 82, 87, 88, 90, 91, 95, 332-335
 Tregenza, Michael: 118, 131
 Trouillet, Dr.: 126
 Tschernoglasova, Raissa: 214
 Türk, Richard: 234, 237
 Turnau, R: 123
 Turowski, Eugeniusz: 25
 Tyszkowa, Maria: 252

— V —

Valeri, Valerio: 256
 van Eipen: 20
 Vareka, P.: 323
 Verduin, Sophie: 259
 Veterman, Jetje: 259
 Veterman, Sientje: 259
 Vidal-Naquet, Pierre: 29
 Vogel, R.: 179
 von Brauchitsch, Walter: 233
 von Manstein, Erich: 210, 211
 von Reichenau: 229
 von Sammern, Ferdinand: 279
 von Schirmeister, Moritz: 182

— W —

Wakulicz: 87
 Walendy, Udo: 20, 42-44, 45, 151, 204, 211
 Warszawski, Szyja: 25, 148, 153, 154
 Wazniewski, Wladyslaw: 29, 33, 47, 48, 51, 62, 278, 328
 Weber, Mark: 16, 45, 277
 Weirauch: 235
 Weissmandel, Dov: 251
 Weliczker, Leon: 228
 Wellers, Georges: 127, 128, 130, 158
 Wesolowski, Franciszek: 77

Wetzel, Erhard: 198
 Wiegand, Arpad: 114
 Wiernik, Jankiel (Yankel): 25, 33, 64, 69-74, 79, 87, 93, 94, 96, 117-121, 132, 135, 141, 147, 151, 152, 154, 155, 299, 322, 330, 331, 333
 Wilhelm, Hans Heinrich: 226, 227, 257
 Wilke, W.: 123
 Willenberg, Samuel: 10, 33, 38, 95, 140, 141, 341
 Wins de Heer, Jozef: 260
 Wirth, Christian: 118, 125, 126, 130, 131
 Wisliceny, Dieter: 247
 Witte, Peter: 194, 269
 Wittmer: 143
 Wojtczak, Stanisław: 32, 84, 88, 89, 92, 102, 115, 139, 140, 332, 333
 Wolff, Karl: 275
 Worm: 263
 Wulf, Josef: 134, 280

— Z —

Zander, Friedrich: 296
 Zdonek, Stanisław: 77
 Zeitschel, Carltheo: 184, 186
 Zemkiewicz, Barbara: 77
 Zepf: 21
 Zernik, F.: 133
 Zylbersztajn, Samuel: 284

HOLOCAUST HANDBOOKS

This ambitious, growing series addresses various aspects of the “Holocaust” of the WWII era. Most of them are based on decades of research from archives all over the world. They are heavily referenced. In contrast to most other works on this issue, the tomes of this series approach its topic with profound academic scrutiny and a critical attitude. Any Holocaust researcher ignoring this series will remain oblivious to some of the most important research in the field. These books are designed to both convince the common reader as well as academics. The following books have appeared so far, or are about to be released. Compare hardcopy and eBook prices at www.findbookprices.com.

SECTION ONE: General Overviews of the Holocaust

The First Holocaust. The Surprising Origin of the Six-Million Figure.

By Don Heddesheimer. This compact but substantive study documents propaganda spread prior to, during and after the FIRST World War that claimed East European Jewry was on the brink of annihilation. The magic number of suffering and dying Jews was 6 million back then as well. The book details how these Jewish fundraising operations in America raised vast sums in the name of feeding suffering Polish and Russian Jews but actually funneled much of the money to Zionist and Communist groups. 5th ed., 200 pages, b&w illustrations, bibliography, index. (#6)



of ideas about this topic. This book gives the most-comprehensive and up-to-date overview of the critical research into the Holocaust. With its dialog style, it is pleasant to read, and it can even be used as an encyclopedic compendium. 3rd ed., 596 pages, b&w illustrations, bibliography, index. (#15)

Lectures on the Holocaust. Controversial Issues Cross Examined.

By Germar Rudolf. This book first explains why “the Holocaust” is an important topic, and that it is well to keep an open mind about it. It then tells how many mainstream scholars expressed doubts and subsequently fell from grace. Next, the physical traces and documents about the various claimed crime scenes and murder weapons are discussed. After that, the reliability of witness testimony is examined. Finally, the author lobbies for a free exchange

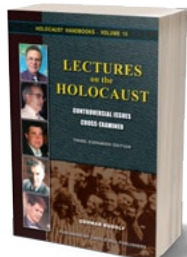

of ideas about this topic. This book gives the most-comprehensive and up-to-date overview of the critical research into the Holocaust. With its dialog style, it is pleasant to read, and it can even be used as an encyclopedic compendium. 3rd ed., 596 pages, b&w illustrations, bibliography, index. (#15)

Breaking the Spell. The Holocaust, Myth & Reality. By Nicholas Kollerstrom. In 1941, British Intelligence analysts cracked the German “Enigma” code. Hence, in 1942 and 1943, encrypted radio communications between German concentration camps and the Berlin headquarters were decrypted. The intercepted data



Pictured above are all of the scientific studies that comprise the series *Holocaust Handbooks* published thus far or are about to be released. More volumes and new editions are constantly in the works. Check www.HolocaustHandbooks.com for updates.

refutes the orthodox “Holocaust” narrative. It reveals that the Germans were desperate to reduce the death rate in their labor camps, which was caused by catastrophic typhus epidemics. Dr. Kollerstrom, a science historian, has taken these intercepts and a wide array of mostly unchallenged corroborating evidence to show that “witness statements” supporting the human gas chamber narrative clearly clash with the available scientific data. Kollerstrom concludes that the history of the Nazi “Holocaust” has been written by the victors with ulterior motives. It is distorted, exaggerated and largely wrong. With a foreword by Prof. Dr. James Fetzer. 5th ed., 282 pages, b&w ill., bibl., index. (#31)

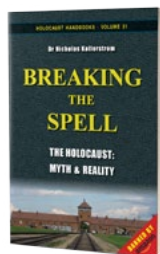

Debating the Holocaust. A New Look at Both Sides.

By Thomas Dalton. Mainstream historians insist that there cannot be, may not be a debate about the Holocaust. But ignoring it does not make this controversy go away. Traditional scholars admit that there was neither a budget, a plan, nor an order for the Holocaust; that the key camps have all but vanished, and so have any human remains; that material and unequivocal documentary evidence is absent; and that there are serious problems with survivor testimonies. Dalton juxtaposes the traditional Holocaust narrative with revisionist challenges and then analyzes the mainstream’s responses to them. He reveals the weaknesses of both sides, while declaring revisionism the winner of the current state

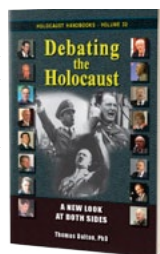

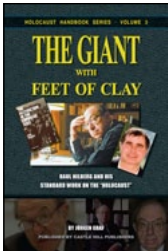
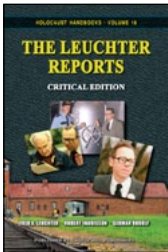
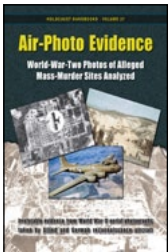
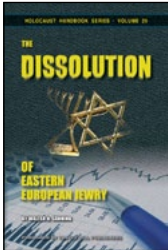
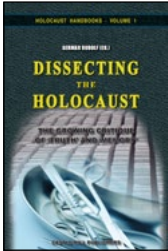
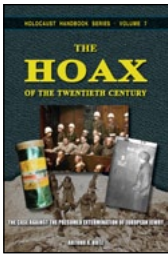

of the debate. 4th ed., 342 pages, b&w illustrations, bibliography, index. (#32)

The Hoax of the Twentieth Century. The Case against the Presumed Extermination of European Jewry. By Arthur R. Butz. The first writer to analyze the entire Holocaust complex in a precise scientific manner. This book exhibits the overwhelming force of arguments accumulated by the mid-1970s. Butz's two main arguments are: 1. All major entities hostile to Germany must have known what was happening to the Jews under German authority. They acted during the war as if no mass slaughter was occurring. 2. All the evidence adduced to proof any mass slaughter has a dual interpretation, while only the innocuous one can be proven to be correct. This book continues to be a major historical reference work, frequently cited by prominent personalities. This edition has numerous supplements with new information gathered over the last 35 years. 4th ed., 524 pages, b&w illustrations, bibliography, index. (#7)

Dissecting the Holocaust. The Growing Critique of 'Truth' and 'Memory.' Edited by Germar Rudolf. *Dissecting the Holocaust* applies state-of-the-art scientific technique and classic methods of detection to investigate the alleged murder of millions of Jews by Germans during World War II. In 22 contributions—each of some 30 pages—the 17 authors dissect generally accepted paradigms of the “Holocaust.” It reads as exciting as a crime novel: so many lies, forgeries and deceptions by politicians, historians and scientists are proven. This is the intellectual adventure of the 21st century. Be part of it! 3rd ed., 635 pages, b&w illustrations, bibliography, index. (#1)

The Dissolution of Eastern European Jewry. By Walter N. Sanning. Six Million Jews died in the Holocaust. Sanning did not take that number at face value, but thoroughly explored European population developments and shifts mainly caused by emigration as well as deportations and evacuations conducted by both Nazis and the Soviets, among other things. The book is based mainly on Jewish, Zionist and mainstream sources. It concludes that a sizeable share of the Jews found missing during local censuses after the Second World War, which were so far counted as “Holocaust victims,” had either emigrated (mainly to Israel or the U.S.) or had been deported by Stalin to Siberian labor camps. 2nd ed., foreword by A.R. Butz, epilogue by Germar Rudolf containing important

updates; 224 pages, b&w illustrations, bibliography (#29).

Air-Photo Evidence: World War Two Photos of Alleged Mass Murder Sites Analyzed. By Germar Rudolf (editor). During World War Two both German and Allied reconnaissance aircraft took countless air photos of places of tactical and strategic interest in Europe. These photos are prime evidence for the investigation of the Holocaust. Air photos of locations like Auschwitz, Majdanek, Treblinka, Babi Yar etc. permit an insight into what did or did not happen there. The author has unearthed many pertinent photos and has thoroughly analyzed them. This book is full of air photo reproductions and schematic drawings explaining them. According to the author, these images refute many of the atrocity claims made by witnesses in connection with events in the German sphere of influence. 6th edition; with a contribution by Carlo Mattogno. 167 pages, 8.5”x11”, b&w illustrations, bibliography, index (#27).

The Leuchter Reports: Critical Edition. By Fred Leuchter, Robert Faurisson and Germar Rudolf. Between 1988 and 1991, U.S. expert on execution technologies Fred Leuchter wrote four detailed reports addressing whether the Third Reich operated homicidal gas chambers. The first report on Auschwitz and Majdanek became world famous. Based on chemical analyses and various technical arguments, Leuchter concluded that the locations investigated “could not have then been, or now be, utilized or seriously considered to function as execution gas chambers.” The second report deals with gas-chamber claims for the camps Dachau, Mauthausen and Hartheim, while the third reviews design criteria and operation procedures of execution gas chambers in the U.S. The fourth report reviews Pressac's 1989 tome *Auschwitz*. 4th ed., 252 pages, b&w illustrations. (#16)

The Giant with Feet of Clay: Raul Hilberg and His Standard Work on the "Holocaust." By Jürgen Graf. Raul Hilberg's major work *The Destruction of European Jewry* is an orthodox standard work on the Holocaust. But what evidence does Hilberg provide to back his thesis that there was a German plan to exterminate Jews, carried out mainly in gas chambers? Jürgen Graf applies the methods of critical analysis to Hilberg's evidence and examines the results in light of modern historiography. The results of Graf's critical analysis are devastating for Hilberg.

2nd, corrected edition, 139 pages, b&w illustrations, bibliography, index. (#3)

Jewish Emigration from the Third Reich. By Ingrid Weckert. Current historical writings about the Third Reich claim state it was difficult for Jews to flee from Nazi persecution. The truth is that Jewish emigration was welcomed by the German authorities. Emigration was not some kind of wild flight, but rather a lawfully determined and regulated matter. Weckert's booklet elucidates the emigration process in law and policy. She shows that German and Jewish authorities worked closely together. Jews interested in emigrating received detailed advice and offers of help from both sides. 2nd ed., 130 pages, index. (#12)

Inside the Gas Chambers: The Extermination of Mainstream Holocaust Historiography. By Carlo Mattogno. Neither increased media propaganda or political pressure nor judicial persecution can stifle revisionism. Hence, in early 2011, the Holocaust Orthodoxy published a 400 pp. book (in German) claiming to refute "revisionist propaganda," trying again to prove "once and for all" that there were homicidal gas chambers at the camps of Dachau, Natzweiler, Sachsenhausen, Mauthausen, Ravensbrück, Neuengamme, Stutthof... you name them. Mattogno shows with his detailed analysis of this work of propaganda that mainstream Holocaust hagiography is beating around the bush rather than addressing revisionist research results. He exposes their myths, distortions and lies. 2nd ed., 280 pages, b&w illustrations, bibliography, index. (#25)

SECTION TWO: Specific non-Auschwitz Studies

Treblinka: Extermination Camp or Transit Camp? By Carlo Mattogno and Jürgen Graf. It is alleged that at Treblinka in East Poland between 700,000 and 3,000,000 persons were murdered in 1942 and 1943. The weapons used were said to have been stationary and/or mobile gas chambers, fast-acting or slow-acting poison gas, unslaked lime, superheated steam, electricity, diesel exhaust fumes etc. Holocaust historians alleged that bodies were piled as high as multi-storied buildings and burned without a trace, using little or no fuel at all. Graf and Mattogno have now analyzed the origins, logic and technical feasibility of the official version of Treblinka. On the basis of numerous documents they reveal Treblinka's true identity as a mere transit

camp. 3rd ed., 384 pages, b&w illustrations, bibliography, index. (#8)

Belzec in Propaganda, Testimonies, Archeological Research and History. By Carlo Mattogno. Witnesses report that between 600,000 and 3 million Jews were murdered in the Belzec camp, located in Poland. Various murder weapons are claimed to have been used: diesel gas; unslaked lime in trains; high voltage; vacuum chambers; etc. The corpses were incinerated on huge pyres without leaving a trace. For those who know the stories about Treblinka this sounds familiar. Thus the author has restricted this study to the aspects which are new compared to Treblinka. In contrast to Treblinka, forensic drillings and excavations were performed at Belzec, the results of which are critically reviewed. 142 pages, b&w illustrations, bibliography, index. (#9)

Sobibor: Holocaust Propaganda and Reality. By Jürgen Graf, Thomas Kues and Carlo Mattogno. Between 25,000 and 2 million Jews are said to have been killed in gas chambers in the Sobibór camp in Poland. The corpses were allegedly buried in mass graves and later incinerated on pyres. This book investigates these claims and shows that they are based on the selective use of contradictory eyewitness testimony. Archeological surveys of the camp are analyzed that started in 2000-2001 and carried on until 2018. The book also documents the general National Socialist policy toward Jews, which never included a genocidal "final solution." 2nd ed., 456 pages, b&w illustrations, bibliography, index. (#19)

The "Extermination Camps" of "Aktion Reinhardt". By Jürgen Graf, Thomas Kues and Carlo Mattogno. In late 2011, several members of the exterminationist *Holocaust Controversies* blog posted a study online which claims to refute three of our authors' monographs on the camps Belzec, Sobibor and Treblinka (see previous three entries). This tome is their point-by-point response, which makes "mincemeat" out of the bloggers' attempt at refutation. **Caution:** The two volumes of this work are an intellectual overkill for most people. They are recommended only for collectors, connoisseurs and professionals. These two books require familiarity with the above-mentioned books, of which they are a comprehensive update and expansion. 2nd ed., two volumes, total of 1396 pages, illustrations, bibliography. (#28)

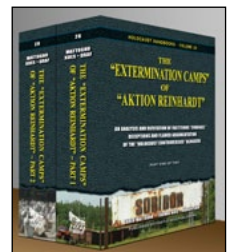
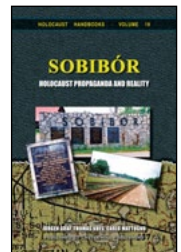
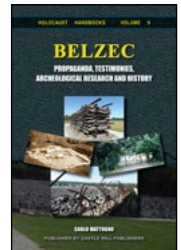
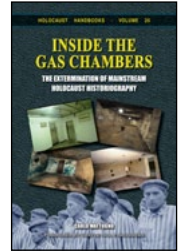
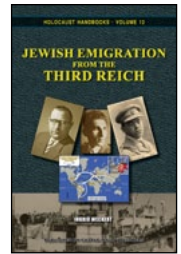

Chelmno: A Camp in History & Propaganda. By Carlo Mattogno. At Chelmno, huge masses of Jewish prisoners are said to have been gassed in “gas vans” or shot (claims vary from 10,000 to 1.3 million victims). This study covers the subject from every angle, undermining the orthodox claims about the camp with an overwhelmingly effective body of evidence. Eyewitness statements, gas wagons as extermination weapons, forensics reports and excavations, German documents—all come under Mattogno’s scrutiny. Here are the uncensored facts about Chelmno, not the propaganda. 2nd ed., 188 pages, indexed, illustrated, bibliography. (#23)

The Gas Vans: A Critical Investigation. By Santiago Alvarez and Pierre Marais. It is alleged that the Nazis used mobile gas chambers to exterminate 700,000 people. Up until 2011, no thorough monograph had appeared on the topic. Santiago Alvarez has remedied the situation. Are witness statements reliable? Are documents genuine? Where are the murder weapons? Could they have operated as claimed? Where are the corpses? In order to get to the truth of the matter, Alvarez has scrutinized all known wartime documents and photos about this topic; he has analyzed a huge amount of witness statements as published in the literature and as presented in more than 30 trials held over the decades in Germany, Poland and Israel; and he has examined the claims made in the pertinent mainstream literature. The result of his research is mind-boggling. Note: This book and Mattogno’s book on Chelmno were edited in parallel to make sure they are consistent and not repetitive. 398 pages, b&w illustrations, bibliography, index. (#26)

The Einsatzgruppen in the Occupied Eastern Territories: Genesis, Missions and Actions. By C. Mattogno. Before invading the Soviet Union, the German authorities set up special units meant to secure the area behind the German front. Orthodox historians claim that these units called *Einsatzgruppen* primarily engaged in rounding up and mass-murdering Jews. This study sheds a critical light into this topic by reviewing all the pertinent sources as well as material traces. It reveals on the one hand that original war-time documents do not fully support the orthodox genocidal narrative, and on the other that most post-“liberation” sources such as testimonies and forensic reports are steeped in Soviet atrocity propaganda and are thus utterly unreliable. In ad-

dition, material traces of the claimed massacres are rare due to an attitude of collusion by governments and Jewish lobby groups. 830 pp., b&w illustrations, bibliography, index. (#39)

Concentration Camp Majdanek. A Historical and Technical Study. By Carlo Mattogno and Jürgen Graf. At war’s end, the Soviets claimed that up to two million Jews were murdered at the Majdanek Camp in seven gas chambers. Over the decades, however, the Majdanek Museum reduced the death toll three times to currently 78,000, and admitted that there were “only” two gas chambers. By exhaustively researching primary sources, the authors expertly dissect and repudiate the myth of homicidal gas chambers at that camp. They also critically investigated the legend of mass executions of Jews in tank trenches and prove them groundless. Again they have produced a standard work of methodical investigation which authentic historiography cannot ignore. 3rd ed., 358 pages, b&w illustrations, bibliography, index. (#5)

Concentration Camp Stutthof and Its Function in National Socialist Jewish Policy. By Carlo Mattogno and Jürgen Graf. Orthodox historians claim that the Stutthof Camp served as a “make-shift” extermination camp in 1944. Based mainly on archival resources, this study thoroughly debunks this view and shows that Stutthof was in fact a center for the organization of German forced labor toward the end of World War II. 4th ed., 170 pages, b&w illustrations, bibliography, index. (#4)

SECTION THREE: Auschwitz Studies

The Making of the Auschwitz Myth: Auschwitz in British Intercepts, Polish Underground Reports and Post-war Testimonies (1941-1947). By Carlo Mattogno. Using messages sent by the Polish underground to London, SS radio messages sent to and from Auschwitz that were intercepted and decrypted by the British, and a plethora of witness statements made during the war and in the immediate postwar period, the author shows how exactly the myth of mass murder in Auschwitz gas chambers was created, and how it was turned subsequently into “history” by intellectually corrupt scholars who cherry-picked claims that fit into their agenda and ignored or actively covered up literally thousands of lies of “witnesses” to make their narrative look credible. Ca. 300

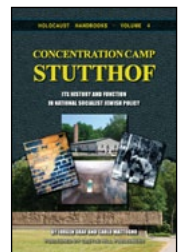
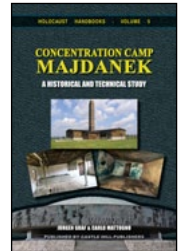
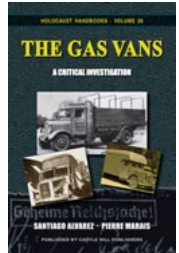
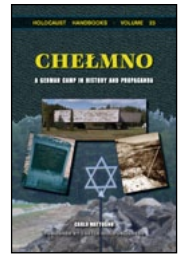

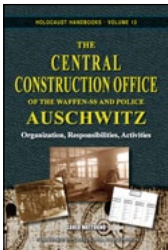
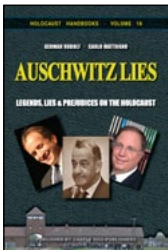
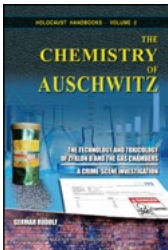
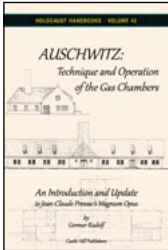
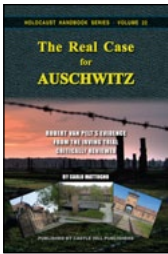

pp., b&w illustrations, bibliography, index. (Scheduled for mid-2020; #41)

The Real Case of Auschwitz: Robert van Pelt's Evidence from the Irving Trial Critically Reviewed. By Carlo Mattogno. Prof. Robert van Pelt is considered one of the best mainstream experts on Auschwitz. He became famous when appearing as an expert during the London libel trial of David Irving against Deborah Lipstadt. From it resulted a book titled *The Case for Auschwitz*, in which van Pelt laid out his case for the existence of homicidal gas chambers at that camp. This book is a scholarly response to Prof. van Pelt—and Jean-Claude Pressac, upon whose books van Pelt's study is largely based. Mattogno lists all the evidence van Pelt adduces, and shows one by one that van Pelt misrepresented and misinterpreted each single one of them. This is a book of prime political and scholarly importance to those looking for the truth about Auschwitz. 3rd ed., 692 pages, b&w illustrations, glossary, bibliography, index. (#22)

Auschwitz: Plain Facts: A Response to Jean-Claude Pressac. Edited by Germar Rudolf, with contributions by Serge Thion, Robert Faurisson and Carlo Mattogno. French pharmacist Jean-Claude Pressac tried to refute revisionist findings with the “technical” method. For this he was praised by the mainstream, and they proclaimed victory over the “revisionists.” In his book, Pressac’s works and claims are shown to be unscientific in nature, as he never substantiate what he claims, and historically false, because he systematically misrepresents, misinterprets and misunderstands German wartime documents. 2nd ed., 226 pages, b&w illustrations, glossary bibliography, index. (#14)

Auschwitz: Technique and Operation of the Gas Chambers: An Introduction and Update. By Germar Rudolf. Pressac’s 1989 oversize book of the same title was a trail blazer. Its many document reproductions are still valuable, but after decades of additional research, Pressac’s annotations are outdated. This book summarizes the most pertinent research results on Auschwitz gained during the past 30 years. With many references to Pressac’s epic tome, it serves as an update and correction to it, whether you own an original hard copy of it, read it online, borrow it from a library, purchase a reprint, or are just interested in such a summary in general. 144 pages, b&w illustrations, bibliography. (#42)

The Chemistry of Auschwitz: The Technology and Toxicology of Zyklon B and the Gas Chambers – A Crime Scene Investigation. By Germar Rudolf. This study documents forensic research on Auschwitz, where material traces and their interpretation reign supreme. Most of the claimed crime scenes – the claimed homicidal gas chambers – are still accessible to forensic examination to some degree. This book addresses questions such as: What did these gas chambers look like? How did they operate? In addition, the infamous Zyklon B can also be examined. What exactly was it? How does it kill? Does it leave traces in masonry that can be found still today? The author also discusses in depth similar forensic research conducted by other authors. 4th ed., 454 pages, more than 120 color and over 100 b&w illustrations, bibliography, index. (#2)

Auschwitz Lies: Legends, Lies and Prejudices on the Holocaust. By C. Mattogno and G. Rudolf. The fallacious research and alleged “refutation” of Revisionist scholars by French biochemist G. Wellers (attacking Leuchter’s famous report), Polish chemist Dr. J. Markiewicz and U.S. chemist Dr. Richard Green (taking on Rudolf’s chemical research), Dr. John Zimmerman (tackling Mattogno on cremation issues), Michael Shermer and Alex Grobman (trying to prove it all), as well as researchers Keren, McCarthy and Mazal (how turned cracks into architectural features), are exposed for what they are: blatant and easily exposed political lies created to ostracize dissident historians. 3rd ed., 398 pages, b&w illustrations, index. (#18)

Auschwitz: The Central Construction Office. By C. Mattogno. Based upon mostly unpublished German wartime documents, this study describes the history, organization, tasks and procedures of the one office which was responsible for the planning and construction of the Auschwitz camp complex, including the crematories which are said to have contained the “gas chambers.” 2nd ed., 188 pages, b&w illustrations, glossary, index. (#13)

Garrison and Headquarters Orders of the Auschwitz Camp. By G. Rudolf and E. Böhm. A large number of all the orders ever issued by the various commanders of the infamous Auschwitz camp have been preserved. They reveal the true nature of the camp with all its daily events. There is not a trace in these orders pointing at anything sinister going on in this camp.

Quite to the contrary, many orders are in clear and insurmountable contradiction to claims that prisoners were mass murdered. This is a selection of the most pertinent of these orders together with comments putting them into their proper historical context. 185 pages, b&w ill., bibl., index (#34)

Special Treatment in Auschwitz: Origin and Meaning of a Term. By C. Mattogno. When appearing in German wartime documents, terms like “special treatment,” “special action,” and others have been interpreted as code words for mass murder. But that is not always true. This study focuses on documents about Auschwitz, showing that, while “special” had many different meanings, not a single one meant “execution.” Hence the practice of deciphering an alleged “code language” by assigning homicidal meaning to harmless documents – a key component of mainstream historiography – is untenable. 2nd ed., 166 pages, b&w illustrations, bibliography, index. (#10)

Healthcare at Auschwitz. By C. Mattogno. In extension of the above study on *Special Treatment in Auschwitz*, this study proves the extent to which the German authorities at Auschwitz tried to provide health care for the inmates. Part 1 of this book analyzes the inmates’ living conditions and the various sanitary and medical measures implemented. Part 2 explores what happened to registered inmates who were “selected” or subject to “special treatment” while disabled or sick. This study shows that a lot was tried to cure these inmates, especially under the aegis of Garrison Physician Dr. Wirths. Part 3 is dedicated to Dr. this very Wirths. His reality refutes the current stereotype of SS officers. 398 pages, b&w illustrations, bibliography, index. (#33)

Debunking the Bunkers of Auschwitz: Black Propaganda vs. History. By Carlo Mattogno. The bunkers at Auschwitz, two former farmhouses just outside the camp’s perimeter, are claimed to have been the first homicidal gas chambers at Auschwitz specifically equipped for this purpose. With the help of original German wartime files as well as revealing air photos taken by Allied reconnaissance aircraft in 1944, this study shows that these homicidal “bunkers” never existed, how the rumors about them evolved as black propaganda created by resistance groups in the camp, and how this propaganda was transformed into a false reality. 2nd ed., 292 pages, b&w ill., bibliography, index. (#11)

Auschwitz: The First Gassing. Rumor and Reality. By C. Mattogno. The first gassing in Auschwitz is claimed to have occurred on Sept. 3, 1941, in a basement room. The accounts reporting it are the archetypes for all later gassing accounts. This study analyzes all available sources about this alleged event. It shows that these sources contradict each other in location, date, victims etc, rendering it impossible to extract a consistent story. Original wartime documents inflict a final blow to this legend and prove without a shadow of a doubt that this legendary event never happened. 3rd ed., 190 pages, b&w illustrations, bibliography, index. (#20)

Auschwitz: Crematorium I and the Alleged Homicidal Gassings. By C. Mattogno. The morgue of Crematorium I in Auschwitz is said to be the first homicidal gas chamber there. This study investigates all statements by witnesses and analyzes hundreds of wartime documents to accurately write a history of that building. Where witnesses speak of gassings, they are either very vague or, if specific, contradict one another and are refuted by documented and material facts. The author also exposes the fraudulent attempts of mainstream historians to convert the witnesses’ black propaganda into “truth” by means of selective quotes, omissions, and distortions. Mattogno proves that this building’s morgue was never a homicidal gas chamber, nor could it have worked as such. 2nd ed., 152 pages, b&w illustrations, bibliography, index. (#21)

Auschwitz: Open Air Incinerations. By C. Mattogno. In spring and summer of 1944, 400,000 Hungarian Jews were deported to Auschwitz and allegedly murdered there in gas chambers. The Auschwitz crematoria are said to have been unable to cope with so many corpses. Therefore, every single day thousands of corpses are claimed to have been incinerated on huge pyres lit in deep trenches. The sky over Auschwitz was covered in thick smoke. This is what some witnesses want us to believe. This book examines the many testimonies regarding these incinerations and establishes whether these claims were even possible. Using air photos, physical evidence and wartime documents, the author shows that these claims are fiction. A new Appendix contains 3 papers on groundwater levels and cattle mass burnings. 2nd ed., 202 pages, b&w illustrations, bibliography, index. (#17)

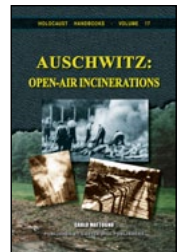
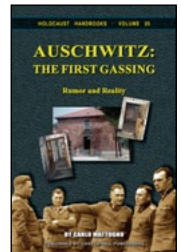
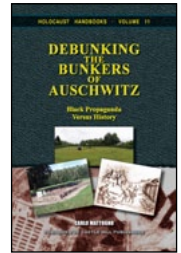
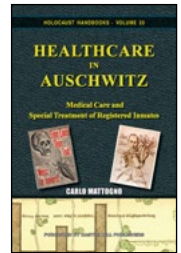
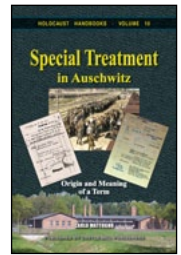

The Cremation Furnaces of Auschwitz. By Carlo Mattogno & Franco Deana. An exhaustive study of the history and technology of cremation in general and of the cremation furnaces of Auschwitz in particular. On a vast base of technical literature, extant wartime documents and material traces, the authors can establish the true nature and capacity of the Auschwitz cremation furnaces. They show that these devices were inferior make-shift versions of what was usually produced, and that their capacity to cremate corpses was lower than normal, too. 3 vols., 1198 pages, b&w and color illustrations (vols 2 & 3), bibliography, index, glossary. (#24)

Curated Lies: The Auschwitz Museum's Misrepresentations, Distortions and Deceptions. By Carlo Mattogno. Revisionist research results have put the Polish Auschwitz Museum under pressure to answer this challenge. They've answered. This book analyzes their answer and reveals the appallingly mendacious attitude of the Auschwitz Museum authorities when presenting documents from their archives. 248 pages, b&w illustrations, bibliography, index. (#38)

Deliveries of Coke, Wood and Zyklon B to Auschwitz: Neither Proof Nor Trace for the Holocaust. By Carlo Mattogno. Researchers from the Auschwitz Museum tried to prove the reality of mass extermination by pointing to documents about deliveries of wood and coke as well as Zyklon B to the Auschwitz Camp. If put into the actual historical and technical context, however, these documents prove the exact opposite of what these orthodox researchers claim. Ca. 250 pages, b&w illust., bibl., index. (Scheduled for 2021; #40)

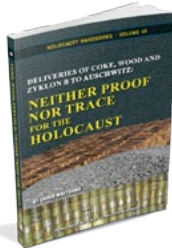

SECTION FOUR: Witness Critique

Elie Wiesel, Saint of the Holocaust: A Critical Biography. By Warren B. Routledge. The first unauthorized biography of Wiesel exposes both his personal deceptions and the whole myth of "the six million." It shows how Zionist control has allowed Wiesel and

his fellow extremists to force leaders of many nations, the U.N. and even popes to genuflect before Wiesel as symbolic acts of subordination to World Jewry, while at the same time forcing school children to submit to Holocaust brainwashing. 3rd ed., 458 pp., b&w illust., bibliography, index. (#30)

Auschwitz: Eyewitness Reports and Perpetrator Confessions. By Jürgen Graf. The traditional narrative of what transpired at the infamous Auschwitz Camp during WWII rests almost exclusively on witness testimony. This study critically scrutinizes the 30 most important of them by checking them for internal coherence, and by comparing them with one another as well as with other evidence such as wartime documents, air photos, forensic research results, and material traces. The result is devastating for the traditional narrative. 372 pages, b&w illust., bibl., index. (#36)

Commandant of Auschwitz: Rudolf Höss, His Torture and His Forced Confessions. By Carlo Mattogno & Rudolf Höss. From 1940 to 1943, Rudolf Höss was the commandant of the infamous Auschwitz Camp. After the war, he was captured by the British. In the following 13 months until his execution, he made 85 depositions of various kinds in which he confessed his involvement in the "Holocaust." This study first reveals how the British tortured him to extract various "confessions." Next, all of Höss's depositions are analyzed by checking his claims for internal consistency and comparing them with established historical facts. The results are eye-opening... 2nd ed., 411 pages, b&w illustrations, bibliography, index. (#35)

An Auschwitz Doctor's Eyewitness Account: The Tall Tales of Dr. Mengele's Assistant Analyzed. By Miklos Nyiszli & Carlo Mattogno. Nyiszli, a Hungarian physician, ended up at Auschwitz in 1944 as Dr. Mengele's assistant. After the war he wrote a book and several other writings describing what he claimed to have experienced. To this day some traditional historians take his accounts seriously, while others reject them as grotesque lies and exaggerations. This study presents and analyzes Nyiszli's writings and skillfully separates truth from fabulous fabrication. 484 pages, b&w illustrations, bibliography, index. (#37)

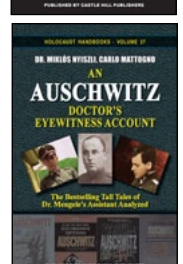
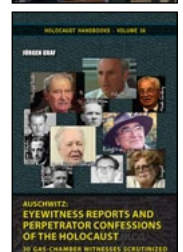
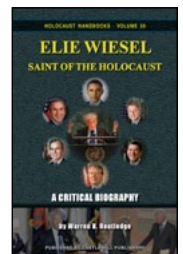
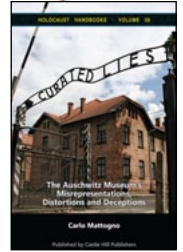
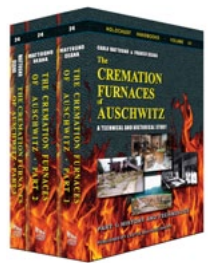

FOR CURRENT PRICES AND AVAILABILITY SEE BOOK FINDER SITES SUCH AS BOOKFINDER.COM, ADDALL.COM, BOOKFINDER4U.COM OR FINDBOOKPRICES.COM; LEARN MORE AT WWW.HOLOCAUSTHANDBOOKS.COM
PUBLISHED BY CASTLE HILL PUBLISHERS, PO Box 243, UCKFIELD, TN22 9AW, UK

BOOKS BY AND FROM CASTLE HILL PUBLISHERS

Below please find some of the books published or distributed by Castle Hill Publishers in the United Kingdom. For our current and complete range of products visit our web store at shop.codoh.com.

Thomas Dalton, *The Holocaust: An Introduction*

The Holocaust was perhaps the greatest crime of the 20th century. Six million Jews, we are told, died by gassing, shooting, and deprivation. But: Where did the six million figure come from? How, exactly, did the gas chambers work? Why do we have so little physical evidence from major death camps? Why haven't we found even a fraction of the six million bodies, or their ashes? Why has there been so much media suppression and governmental censorship on this topic? In a sense, the Holocaust is the greatest murder mystery in history. It is a topic of greatest importance for the present day. Let's explore the evidence, and see where it leads.

128 pp. pb, 5"×8", ill., bibl., index

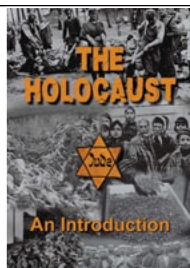

Carlo Mattogno, *Auschwitz: A Three-Quarter Century of*

Propaganda: Origins, Development and Decline of the "Gas Chamber" Propaganda Lie

During the war, wild rumors were circulating about Auschwitz: that the Germans were testing new war gases; that inmates were murdered in electrocution chambers, with gas showers or pneumatic hammer systems; that living people were sent on conveyor belts directly into cremation furnaces; that oils, grease and soap were made of the mass-murder victims. Nothing of it was true. When the Soviets captured Auschwitz in early 1945, they reported that 4 million inmates were killed on electrocution conveyor belts discharging their load directly into furnaces. That wasn't true either. After the war, "witnesses" and "experts" repeated these things and added more fantasies: mass murder with gas bombs, gas chambers made of canvas; carts driving living people into furnaces; that the crematoria of Auschwitz could have cremated 400 million victims... Again, none of it was true. This book gives an overview of the many rumors, myths and lies about Auschwitz which mainstream historians today reject as untrue. It then explains by which ridiculous methods some claims about Auschwitz were accepted as true and turned into "history," although they are just as untrue.

125 pp. pb, 5"×8", ill., bibl., index, b&w ill.

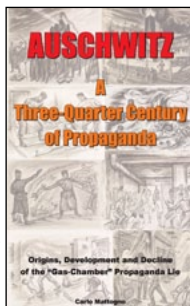

Wilhelm Stäglich, *Auschwitz: A Judge Looks at the Evidence*

Auschwitz is the epicenter of the Holocaust, where more people are said to have been murdered than anywhere else. At this detention camp the industrialized Nazi mass murder is said to have reached its demonic pinnacle. This narrative is based on a wide range of evidence, the most important of which was presented during two trials: the International Military Tribunal of 1945/46, and the German Auschwitz Trial of 1963-1965 in Frankfurt.

The late Wilhelm Stäglich, until the mid-1970s a German judge, has so far been the only legal expert to critically analyze this evidence. His research reveals the incredibly scandalous way in which the Allied victors and later the German judicial authorities bent and broke the law in order to come to politically foregone conclusions. Stäglich also exposes the shockingly superficial way in which historians are dealing with the many incongruities and discrepancies of the historical record.

3rd edition 2015, 422 pp. pb, 6"×9", b&w ill.

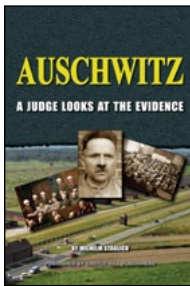

Gerard Menuhin: *Tell the Truth & Shame the Devil*

A prominent Jew from a famous family says the "Holocaust" is a wartime propaganda myth which has turned into an extortion racket. Far from bearing the sole guilt for starting WWII as alleged at Nuremberg (for which many of the surviving German leaders were hanged) Germany is mostly innocent in this respect and made numerous attempts to avoid and later to end the confrontation. During the 1930s Germany was confronted by a powerful Jewish-dominated world plutocracy out to destroy it... Yes, a prominent Jew says all this. Accept it or reject it, but be sure to read it and judge for yourself!

The author is the son of the great American-born violinist Yehudi Menuhin, who, though from a long line of rabbinical ancestors, fiercely criticized the foreign policy of the state of Israel and its repression of the Palestinians in the Holy Land.

4th edition 2017, 432 pp. pb, 6"×9", b&w ill.

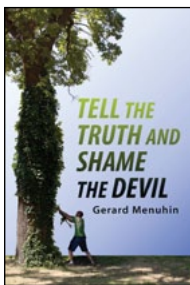

For prices and availability see www.shop.codoh.com or write to: CHP, PO Box 243, Uckfield, TN22 9AW, UK

Robert H. Countess, Christian Lindtner, Germar Rudolf (eds.),

Exactitude: Festschrift for Prof. Dr. Robert Faurisson

On January 25, 1929, a man was born who probably deserves the title of the most courageous intellectual of the 20th century and the beginning of the 21st century: Robert Faurisson. With bravery and steadfastness, he challenged the dark forces of historical and political fraud with his unrelenting exposure of their lies and hoaxes surrounding the orthodox Holocaust narrative. This book describes and celebrates the man, who passed away on October 21, 2018, and his work dedicated to accuracy and marked by insubmission.

146 pp. pb, 6"×9", b&w ill.

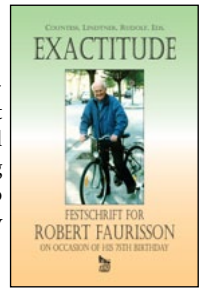

Cyrus Cox, ***Auschwitz – Forensically Examined***

It is amazing what modern forensic crime-scene investigations can find out. This is also true for the Holocaust. There are many big tomes about this, such as Rudolf's 400+ page book on the *Chemistry of Auschwitz*, or Mattogno's 1200-page work on the crematoria of Auschwitz. But who reads those doorstops? Here is a booklet that condenses the most-important findings of Auschwitz forensics into a nutshell, quick and easy to read. In the first section, the forensic investigations conducted so far are reviewed. In the second section, the most-important results of these studies are summarized, making them accessible to everyone. The main arguments focus on two topics. The first centers around the poison allegedly used at Auschwitz for mass murder: Zyklon B. Did it leave any traces in masonry where it was used? Can it be detected to this day? The second topic deals with mass cremations. Did the crematoria of Auschwitz have the claimed huge capacity claimed for them? Do air photos taken during the war confirm witness statements on huge smoking pyres? Find the answers to these questions in this booklet, together with many references to source material and further reading. The third section reports on how the establishment has reacted to these research results.

124 pp. pb., 5"×8", b&w ill., bibl., index

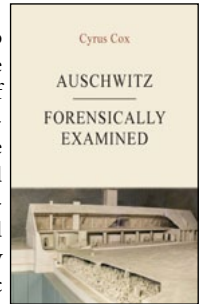

Steffen Werner, ***The Second Babylonian Captivity: The Fate of the Jews in Eastern Europe since 1941***

“But if they were not murdered, where did the six million deported Jews end up?” This is a standard objection to the revisionist thesis that the Jews were not killed in extermination camps. It demands a well-founded response. While researching an entirely different topic, Steffen Werner accidentally stumbled upon the most-peculiar demographic data of Byelorussia. Years of research subsequently revealed more and more evidence which eventually allowed him to substantiate a breathtaking and sensational proposition: The Third Reich did indeed deport many of the Jews of Europe to Eastern Europe in order to settle them there “in the swamp.” This book, first published in German in 1990, was the first well-founded work showing what really happened to the Jews deported to the East by the National Socialists, how they have fared since, and who, what and where they are “now” (1990). It provides context and purpose for hitherto-obscure and seemingly arbitrary historical events and quite obviates all need for paranormal events such as genocide, gas chambers, and all their attendant horrors. With a preface by Germar Rudolf with references to more-recent research results in this field of study confirming Werner's thesis.

190 pp. pb, 6"×9", b&w ill., bibl., index

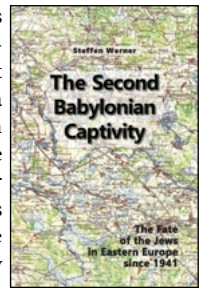

Germar Rudolf, ***Holocaust Skepticism: 20 Questions and Answers about Holocaust Revisionism***

This 15-page brochure introduces the novice to the concept of Holocaust revisionism, and answers 20 tough questions, among them: What does Holocaust revisionism claim? Why should I take Holocaust revisionism more seriously than the claim that the earth is flat? How about the testimonies by survivors and confessions by perpetrators? What about the pictures of corpse piles in the camps? Why does it matter how many Jews were killed by the Nazis, since even 1,000 would have been too many? ... Glossy full-color brochure. PDF file free of charge available at www.HolocaustHandbooks.com, [Option "Promotion"](#). This item is *not* copyright-protected. Hence, you can do with it whatever you want: download, post, email, print, multiply, hand out, sell...

15 pp., stapled, 8.5"×11", full-color throughout

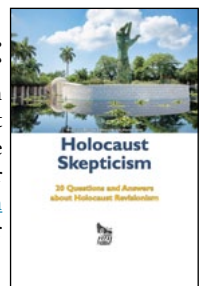

For prices and availability see www.shop.codoh.com or write to: CHP, PO Box 243, Uckfield, TN22 9AW, UK

Germar Rudolf, **Bungled: "Denying the Holocaust"** How Deborah Lipstadt Botched Her Attempt to Demonstrate the Growing Assault on Truth and Memory

With her book *Denying the Holocaust*, Deborah Lipstadt tried to show the flawed methods and extremist motives of "Holocaust deniers." This book demonstrates that Dr. Lipstadt clearly has neither understood the principles of science and scholarship, nor has she any clue about the historical topics she is writing about. She misquotes, mistranslates, misrepresents, misinterprets, and makes a plethora of wild claims without backing them up with anything. Rather than dealing thoroughly with factual arguments, Lipstadt's book is full of *ad hominem* attacks on her opponents. It is an exercise in anti-intellectual pseudo-scientific arguments, an exhibition of ideological radicalism that rejects anything which contradicts its preset conclusions. **F for FAIL**

2nd ed., 224 pp. pb, 5"×8", bibl., index, b&w ill.

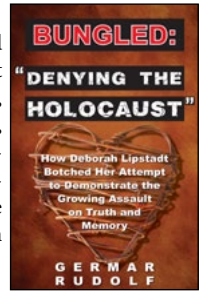

Carolus Magnus, **Bungled: "Denying History"**. How Michael Shermer and Alex Grobman Botched Their Attempt to Refute Those Who Say the Holocaust Never Happened

Skeptic Magazine editor Michael Shermer and Alex Grobman from the Simon Wiesenthal Center wrote a book in 2000 which they claim is "a thorough and thoughtful answer to all the claims of the Holocaust deniers." In 2009, a new "updated" edition appeared with the same ambitious goal. In the meantime, revisionists had published some 10,000 pages of archival and forensic research results. Would their updated edition indeed answer all the revisionist claims? In fact, Shermer and Grobman completely ignored the vast amount of recent scholarly studies and piled up a heap of falsifications, contortions, omissions, and fallacious interpretations of the evidence. Finally, what the authors claim to have demolished is not revisionism but a ridiculous parody of it. They ignored the known unreliability of their cherry-picked selection of evidence, utilizing unverified and incestuous sources, and obscuring the massive body of research and all the evidence that dooms their project to failure. **F for FAIL**

162 pp. pb, 5"×8", bibl., index, b&w ill.



Carolus Magnus, **Bungled: "Debunking Holocaust Denial Theories"**. How James and Lance Morcan Botched Their Attempt to Affirm the Historicity of the Nazi Genocide

The novelists and movie-makers James and Lance Morcan have produced a book "to end [Holocaust] denial once and for all." To do this, "no stone was left unturned" to verify historical assertions by presenting "a wide array of sources" meant "to shut down the debate deniers wish to create. One by one, the various arguments Holocaust deniers use to try to discredit wartime records are carefully scrutinized and then systematically disproven." It's a lie. First, the Morcans completely ignored the vast amount of recent scholarly studies published by revisionists; they didn't even identify them. Instead, they engaged in shadowboxing, creating some imaginary, bogus "revisionist" scarecrow which they then tore to pieces. In addition, their knowledge even of their own side's source material was dismal, and the way they backed up their misleading or false claims was pitifully inadequate. **F for FAIL**.

144 pp. pb, 5"×8", bibl., index, b&w ill.

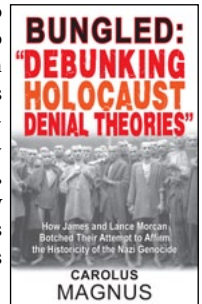

Joachim Hoffmann, **Stalin's War of Extermination 1941-1945**

A German government historian documents Stalin's murderous war against the German army and the German people. Based on the author's lifelong study of German and Russian military records, this book reveals the Red Army's grisly record of atrocities against soldiers and civilians, as ordered by Stalin. Since the 1920s, Stalin planned to invade Western Europe to initiate the "World Revolution." He prepared an attack which was unparalleled in history. The Germans noticed Stalin's aggressive intentions, but they underestimated the strength of the Red Army. What unfolded was the most-cruel war in history. This book shows how Stalin and his Bolshevik henchman used unimaginable violence and atrocities to break any resistance in the Red Army and to force their unwilling soldiers to fight against the Germans. The book explains how Soviet propagandists incited their soldiers to unlimited hatred against everything German, and he gives the reader a short but extremely unpleasant glimpse into what happened when these Soviet soldiers finally reached German soil in 1945: A gigantic wave of looting, arson, rape, torture, and mass murder...

428 pp. pb, 6"×9", bibl., index, b&w ill.

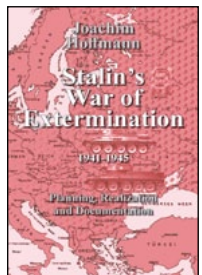

Udo Walendy, *Who Started World War II: Truth for a War-Torn World*

For seven decades, mainstream historians have insisted that Germany was the main, if not the sole culprit for unleashing World War II in Europe. In the present book this myth is refuted. There is available to the public today a great number of documents on the foreign policies of the Great Powers before September 1939 as well as a wealth of literature in the form of memoirs of the persons directly involved in the decisions that led to the outbreak of World War II. Together, they made possible Walendy's present mosaic-like reconstruction of the events before the outbreak of the war in 1939. This book has been published only after an intensive study of sources, taking the greatest care to minimize speculation and inference. The present edition has been translated completely anew from the German original and has been slightly revised.

500 pp. pb, 6"×9", index, bibl., b&w ill.



Germar Rudolf: *Resistance is Obligatory!*

In 2005 Rudolf, a peaceful dissident and publisher of revisionist literature, was kidnapped by the U.S. government and deported to Germany. There the local lackey regime staged a show trial against him for his historical writings. Rudolf was not permitted to defend his historical opinions, as the German penal law prohibits this. Yet he defended himself anyway: 7 days long Rudolf held a speech in the court room, during which he proved systematically that only the revisionists are scholarly in their attitude, whereas the Holocaust orthodoxy is merely pseudo-scientific. He then explained in detail why it is everyone's obligation to resist, without violence, a government which throws peaceful dissident into dungeons. When Rudolf tried to publish his public defence speech as a book from his prison cell, the public prosecutor initiated a new criminal investigation against him. After his probation time ended in 2011, he dared publish this speech anyway...

2nd ed. 2016, 378 pp. pb, 6"×9", b&w ill.

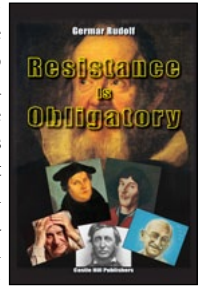

Germar Rudolf, *Hunting Germar Rudolf: Essays on a Modern-Day Witch Hunt*

German-born revisionist activist, author and publisher Germar Rudolf describes which events made him convert from a Holocaust believer to a Holocaust skeptic, quickly rising to a leading personality within the revisionist movement. This in turn unleashed a tsunami of persecution against him: loss of his job, denied PhD exam, destruction of his family, driven into exile, slandered by the mass media, literally hunted, caught, put on a show trial where filing motions to introduce evidence is illegal under the threat of further prosecution, and finally locked up in prison for years for nothing else than his peaceful yet controversial scholarly writings. In several essays, Rudolf takes the reader on a journey through an absurd world of government and societal persecution which most of us could never even fathom actually exists...

304 pp. pb, 6"×9", bibl., index, b&w ill.

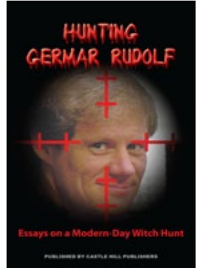

Germar Rudolf, *The Day Amazon Murdered History*

Amazon is the world's biggest book retailer. They dominate the U.S. and several foreign markets. Pursuant to the 1998 declaration of Amazon's founder Jeff Bezos to offer "the good, the bad and the ugly," customers once could buy every book that was in print and was legal to sell. However, in early 2017, a series of anonymous bomb threats against Jewish community centers occurred in the U.S., fueling a campaign by Jewish groups to coax Amazon into banning revisionist writings, false portraying them as anti-Semitic. On March 6, 2017, Amazon caved in and banned more than 100 books with dissenting viewpoints on the Holocaust. In April 2017, an Israeli Jew was arrested for having placed the fake bomb threats, a paid "service" he had offered for years. But that did not change Amazon's mind. Its stores remain closed for history books Jewish lobby groups disapprove of. This book accompanies the documentary of the same title. Both reveal how revisionist publications had become so powerfully convincing that the powers that be resorted to what looks like a dirty false-flag operation in order to get these books banned from Amazon...

128 pp. pb, 5"×8", bibl., b&w ill.

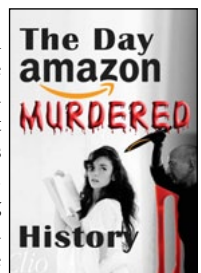

FOR CURRENT PRICES AND AVAILABILITY SEE BOOK FINDER SITES SUCH AS WWW.BOOKFINDER.COM, WWW.ADDALL.COM, WWW.BOOKFINDER4U.COM OR WWW.FINDBOOKPRICES.COM; LEARN MORE AT SHOP.CODOH.COM. PUBLISHED BY CASTLE HILL PUBLISHERS, PO BOX 243, UCKFIELD, TN22 9AW, UK

Thomas Dalton, *Hitler on the Jews*

That Adolf Hitler spoke out against the Jews is beyond obvious. But of the thousands of books and articles written on Hitler, virtually none quotes Hitler's exact words on the Jews. The reason for this is clear: Those in positions of influence have incentives to present a simplistic picture of Hitler as a blood-thirsty tyrant. However, Hitler's take on the Jews is far more complex and sophisticated. In this book, for the first time, you can make up your own mind by reading nearly every idea that Hitler put forth about the Jews, in considerable detail and in full context. This is the first book ever to compile his remarks on the Jews. As you will discover, Hitler's analysis of the Jews, though hostile, is erudite, detailed, and – surprise, surprise – largely aligns with events of recent decades. There are many lessons here for the modern-day world to learn.

200 pp. pb, 6"×9", index, bibl.



Thomas Dalton, *Goebbels on the Jews*

From the age of 26 until his death in 1945, Joseph Goebbels kept a near-daily diary. From it, we get a detailed look at the attitudes of one of the highest-ranking men in Nazi Germany. Goebbels shared Hitler's dislike of the Jews, and likewise wanted them totally removed from the Reich territory. Ultimately, Goebbels and others sought to remove the Jews completely from the Eurasian land mass—perhaps to the island of Madagascar. This would be the “final solution” to the Jewish Question. Nowhere in the diary does Goebbels discuss any Hitler order to kill the Jews, nor is there any reference to extermination camps, gas chambers, or any methods of systematic mass-murder. Goebbels acknowledges that Jews did indeed die by the thousands; but the range and scope of killings evidently fall far short of the claimed figure of 6 million. This book contains, for the first time, every significant diary entry relating to the Jews or Jewish policy. Also included are partial or full citations of 10 major essays by Goebbels on the Jews.

274 pp. pb, 6"×9", index, bibl.



Thomas Dalton, *The Jewish Hand in the World Wars*

For many centuries, Jews have had a negative reputation in many countries. The reasons given are plentiful, but less well known is their involvement in war. When we examine the causal factors for war, and look at its primary beneficiaries, we repeatedly find a Jewish presence. Throughout history, Jews have played an exceptionally active role in promoting and inciting war. With their long-notorious influence in government, we find recurrent instances of Jews promoting hardline stances, being uncompromising, and actively inciting people to hatred. Jewish misanthropy, rooted in Old Testament mandates, and combined with a ruthless materialism, has led them, time and again, to instigate warfare if it served their larger interests. This fact explains much about the present-day world. In this book, Thomas Dalton examines in detail the Jewish hand in the two world wars. Along the way, he dissects Jewish motives and Jewish strategies for maximizing gain amidst warfare, reaching back centuries.

197 pp. pb, 6"×9", index, bibl.



Thomas Dalton, *Eternal Strangers: Critical Views of Jews and Judaism Through the Ages*

It is common knowledge that Jews have been disliked for centuries—sometimes loathed, sometimes hated. But why? The standard reply is that anti-Semitism is a “disease” that, for some strange reason, has afflicted non-Jews for ages. But this makes little sense. Nor can it be an “irrational” reaction. Such things must have real, physical causal factors. Our best hope for understanding this recurrent ‘anti-Semitism’ is to study the history: to look at the actual words written by prominent critics of the Jews, in context, and with an eye to any common patterns that might emerge. Such a study reveals strikingly consistent observations: Jews are seen as pernicious, conniving, shifty liars; they harbor a deep-seated hatred of humanity; they are at once foolish and arrogant; they are socially disruptive and rebellious; they are ruthless exploiters and parasites; they are master criminals—the list goes on.

The persistence of such comments is remarkable and strongly suggests that the cause for such animosity resides in the Jews themselves—in their attitudes, their values, their ethnic traits and their beliefs. It is hard to come to any other conclusion than that Jews are inclined toward actions that trigger a

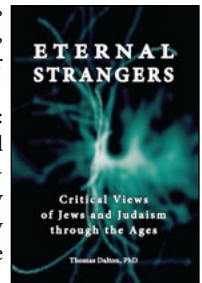

For prices and availability see www.shop.codoh.com or write to: CHP, PO Box 243, Uckfield, TN22 9AW, UK

revulsion in non-Jews. Jews have always been, and will always be, eternal strangers. Given this fact, we have a difficult path forward. One lesson of history is that Jews will not change; if anything, they will become better at hiding their real motives and intents. Under such conditions, many great thinkers have come to the conclusion that Jews must be separated from the rest of humanity.

Eternal Strangers is a profoundly important book. It addresses the modern-day “Jewish problem” in all its depth—something which is arguably at the root of many of the world’s social, political and economic problems. The matter is urgent; we haven’t a moment to lose.

186 pp. pb, 6”x9”; index, bibl.

The Queen versus Zündel: *The First Zündel Trial: The Transcript*

In the early 1980s, Ernst Zündel, a German immigrant living in Toronto, was indicted for allegedly spreading “false news” by selling copies of Richard Hardwood’s brochure *Did Six Million Really Die?*, which challenged the accuracy of the orthodox Holocaust narrative. When the case went to court in 1985, so-called Holocaust experts and “eyewitnesses” of the alleged homicidal gas chambers at Auschwitz were cross-examined for the first time in history by a competent and skeptical legal team. The results were absolutely devastating for the Holocaust orthodoxy. Even the prosecutor, who had summoned these witnesses to bolster the mainstream Holocaust narrative, became at times annoyed by their incompetence and mendacity. For decades, these mind-boggling trial transcripts were hidden from public view. Now, for the first time, they have been published in print in this new book – unabridged and unedited.

ca. 820 pp. pb, 8.5”x11”

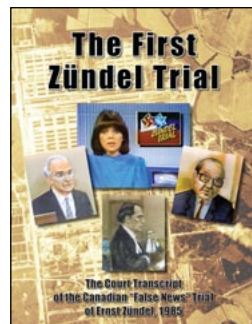

Barbara Kulaszka (ed.), *The Second Zündel Trial: Excerpts from the Transcript*

In 1988, German-Canadian Ernst Zündel was for on trial a second time for allegedly spreading “false news” about the Holocaust. Zündel staged a magnificent defense in an attempt to prove that revisionist concepts of “the Holocaust” are essentially correct. Although many of the key players have since passed away, including Zündel, this historic trial keeps having an impact. It inspired major research efforts as expounded in the series *Holocaust Handbooks*. In contrast to the First Zündel Trial of 1985, the second trial had a much greater impact internationally, mainly due to the *Leuchter Report*, the first independent forensic research performed on Auschwitz, which was endorsed on the witness stand by British bestselling historian David Irving. The present book features the essential contents of this landmark trial with all the gripping, at-times-dramatic details. When Amazon.com decided to ban this 1992 book on a landmark trial about the “Holocaust”, we decided to put it back in print, lest censorship prevail...

498 pp. pb, 8.5”x11”, bibl., index, b&w ill.

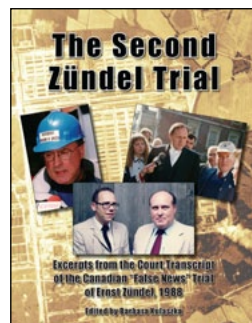

Gerard Menuhin: *Lies & Gravy: Landmarks in Human Decay – Two Plays*

A long time ago, in a galaxy far, far away, the hallucination of global supremacy was born. Few paid it any attention. After centuries of interference, when the end is in sight, we’re more inclined to take it seriously. But now, we have only a few years of comparative freedom left before serfdom submerges us all. So it’s time to summarize our fall and to name the guilty, or, as some have it, to spot the loony. Sometimes the message is so dire that the only way to get it across is with humor – to act out our predicament and its causes. No amount of expert testimony can match the power of spectacle. Here, at times through the grotesque violence typical of Grand Guignol, at times through the milder but no-less-horrifying conspiracies of men incited by a congenital disorder to fulfill their drive for world domination, are a few of the most-telling stages in their crusade against humanity, and their consequences, as imagined by the author.

We wonder whether these two consecutive plays will ever be performed onstage...

112 pp. pb, 5”x8”

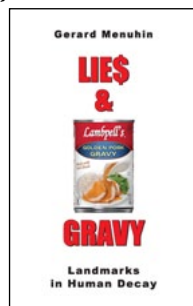

TREBLINKA: EXTERMINATION CAMP OR TRANSIT CAMP?

Holocaust survivors report that at least 700,000 – if not as many as three million – people, primarily Jews, were murdered in the Treblinka Camp, located in eastern Poland, between the summers of 1942 and 1943. Various murder weapons are claimed to have been used: mobile or stationary gas chambers, quicklime, hot steam, high voltage electricity, machine guns, vacuum chambers, chlorine gas, Zyklon B, and diesel exhaust gas. According to the witnesses, the corpses of the victims were first buried in mass graves, but ultimately exhumed and incinerated on huge wood pyres as high as a multi-story building without leaving any traces.

In the first part of this book, the official portrait of Treblinka is subjected to a thorough critique regarding its historical genesis, inner logic, and technical feasibility. The result of this analysis is essentially that the historical picture, which is prescribed by penal law in many European countries, is untenable, because it is little more than an unbroken chain of absurdities.

In the second part of this book, the authors attempt to determine the real function of the Treblinka camp with the help of witness statements, documents, and forensic findings. Through their analysis, they conclude that Treblinka was a transit camp, through which Jews from Warsaw and other areas were led on their way either to occupied Soviet territories, the Majdanek Camp or other labor camps in the area south of Treblinka. Third edition with an update on forensic research conducted in 2010/2011.

Castle Hill Publishers
PO Box 243
Uckfield, TN22 9AW
Great Britain

ISSN 1529-7748
ISBN 1-59148-252-6



9 781591 482529 >